

# DFS60S-SE0K01024

DFS60S Pro

INCREMENTAL ENCODERS

**SICK**  
Sensor Intelligence.

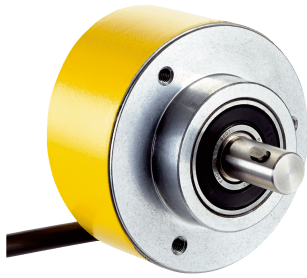

Illustration may differ



### Ordering information

Type	Part no.
DFS60S-SEOK01024	1067913

Other models and accessories → [www.sick.com/DFS60S\\_Pro](http://www.sick.com/DFS60S_Pro)

### Detailed technical data

#### Safety-related parameters

<b>Safety integrity level</b>	SIL 2 (IEC 61508), SILCL2 (IEC 62061) <sup>1)</sup>
<b>Performance level</b>	PL d (EN ISO 13849) <sup>1)</sup>
<b>Category</b>	3 (EN ISO 13849)
<b>PFH<sub>D</sub>: Probability of dangerous failure per hour</b>	1.7 x 10 <sup>-8 2)</sup>
<b>T<sub>M</sub> (mission time)</b>	20 years (EN ISO 13849)
<b>Safety-related measuring step</b>	0.09°, Quadrature analysis
<b>Safety-related accuracy</b>	± 0.09°

<sup>1)</sup> For more detailed information on the exact configuration of your machine/unit, please consult your relevant SICK branch office.

<sup>2)</sup> The values displayed apply to a diagnostic degree of coverage of 99%, which must be achieved by the external drive system and 95 °C operating temperature.

#### Performance

<b>Sine/cosine periods per revolution</b>	1,024
<b>Measuring step</b>	0.3", For interpolation of the sine/cosine signals with e.g. 12 bit <sup>1)</sup>
<b>Integral non-linearity</b>	Typ. ± 45" (without mechanical tension of the stator coupling)
<b>Differential non-linearity</b>	± 7"

<sup>1)</sup> Not safety-related.

#### Interfaces

<b>Communication interface</b>	Incremental
<b>Communication Interface detail</b>	Sin/Cos <sup>1)</sup>
<b>Initialization time</b>	50 ms <sup>2)</sup>
<b>Output frequency</b>	≤ 153.6 kHz
<b>Power consumption</b>	≤ 0.7 W (without load)
<b>Load resistance</b>	≥ 120 Ω

<sup>1)</sup> 1.0 V<sub>SS</sub> (differential).

<sup>2)</sup> Valid signals can be read once this time has elapsed.

## Electrical data

<b>Connection type</b>	Cable, 8-wire, universal, 1.5 m <sup>1)</sup>
<b>Supply voltage</b>	4.5 ... 32 V
<b>Reference signal, number</b>	1
<b>Reference signal, position</b>	90°, electronically, gated with Sinus and Cosinus
<b>Reverse polarity protection</b>	✓
<b>Protection class</b>	III (according to DIN EN 61140)
<b>Short-circuit protection of the outputs</b>	✓ <sup>2)</sup>

<sup>1)</sup> The universal cable connection is positioned so that it can be laid in a radial or axial direction without any kinks. UL approval not available.

<sup>2)</sup> Short-circuit to another channel or GND permitted for max. 30 s. In the case of  $U_S \leq 12$  V additional short-circuit to  $U_S$  permitted for max. 30 s.

## Mechanical data

<b>Mechanical design</b>	Solid shaft, face mount flange
<b>Shaft diameter</b>	10 mm With feather key
<b>Shaft length</b>	19 mm
<b>Weight</b>	Approx. 0.3 kg <sup>1)</sup>
<b>Shaft material</b>	Stainless steel
<b>Flange material</b>	Aluminum
<b>Housing material</b>	Aluminum die cast
<b>Start up torque</b>	$\leq 0.5$ Ncm (+20 °C)
<b>Operating torque</b>	$\leq 0.3$ Ncm (+20 °C)
<b>Permissible shaft loading</b>	80 N (radial) 40 N (axial)
<b>Operating speed</b>	$\leq 9,000$ min <sup>-1</sup> <sup>2)</sup>
<b>Moment of inertia of the rotor</b>	8 gcm <sup>2</sup>
<b>Bearing lifetime</b>	$3.6 \times 10^9$ revolutions <sup>3)</sup>
<b>Angular acceleration</b>	$\leq 500,000$ rad/s <sup>2</sup>

<sup>1)</sup> Based on encoder with male connector.

<sup>2)</sup> Allow for self-heating of approx. 3.0 K per 1,000 rpm regarding the permissible operating temperature.

<sup>3)</sup> On maximum operating speed and temperature.

## Ambient data

<b>EMC</b>	According to EN 61000-6-2, EN 61000-6-3 and IEC 61326-3-1
<b>Enclosure rating</b>	IP65 (IEC 60529) <sup>1)</sup>
<b>Permissible relative humidity</b>	90 % (Condensation not permitted)
<b>Operating temperature range</b>	-30 °C ... +85 °C <sup>2)</sup>
<b>Storage temperature range</b>	-30 °C ... +85 °C, without package
<b>Resistance to shocks</b>	100 g, 6 ms (EN 60068-2-27) <sup>3)</sup>
<b>Resistance to vibration</b>	30 g, 10 Hz ... 1,000 Hz (EN 60068-2-6)

<sup>1)</sup> With male connector and mating connector fitted minimum IP65.

<sup>2)</sup> Allow for self-heating of approx. 3.0 K per 1,000 rpm regarding the permissible operating temperature.

<sup>3)</sup> Checked to operation with vector length monitoring.

### Classifications

<b>eCl@ss 5.0</b>	27270501
<b>eCl@ss 5.1.4</b>	27270501
<b>eCl@ss 6.0</b>	27270590
<b>eCl@ss 6.2</b>	27270590
<b>eCl@ss 7.0</b>	27270501
<b>eCl@ss 8.0</b>	27270501
<b>eCl@ss 8.1</b>	27270501
<b>eCl@ss 9.0</b>	27270501
<b>eCl@ss 10.0</b>	27270501
<b>eCl@ss 11.0</b>	27270501
<b>eCl@ss 12.0</b>	27270501 </td
<b>ETIM 5.0</b>	EC001486
<b>ETIM 6.0</b>	EC001486
<b>ETIM 7.0</b>	EC001486
<b>ETIM 8.0</b>	EC001486
<b>UNSPSC 16.0901</b>	41112113

### Dimensional drawing (Dimensions in mm (inch))

Solid shaft, face mount flange, cable

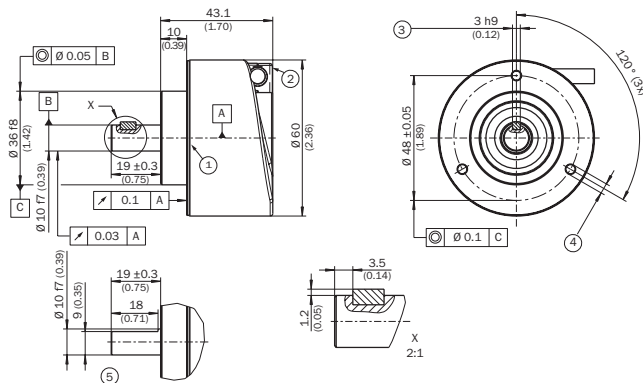

- ① Operating temperature measuring point (freely selectable, around the housing surface area in each case, approx. 3 mm away from flange)
- ② Measuring point vibration (respectively at the housing face. approx. 3 mm away from the cover edge)
- ③ Square key, DIN 6885-A 3x3x6
- ④ M3 / M4 (3x) (6 mm deep)
- ⑤ Shaft with flat

PIN assignment

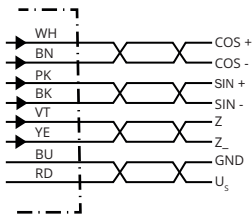

PIN Male connector M12, 8-pin	PIN Male connector M23, 12-pin	Wire colors (cable connection)	Signal	Explanation
1	6	Brown	- COS	Signal wire
2	5	White	+ COS	Signal wire
3	1	Black	- SIN	Signal wire
4	8	Pink	+ SIN	Signal wire
5	4	Yellow		Signal (do not use for safety operating mode)
6	3	Violet	Z	Signal (do not use for safety operating mode)
7	10	Blue	GND	Ground connection
8	12	Red	U <sub>s</sub>	Supply voltage (volt-free to housing)
-	9	-	N.C.	Not assigned
-	2	-	N.C.	Not assigned
-	11	-	N.C.	Not assigned
-	7	-	N.C.	Not assigned
Screen	Screen	Screen	Screen	Screen connected to encoder housing Screen connected to housing on encoder side. Connected to ground on control side.

Diagrams

Signal SIN/COS before differential generation

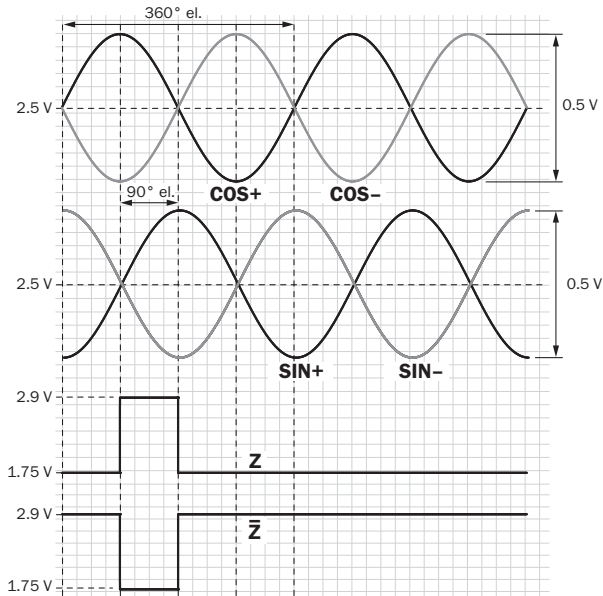

For clockwise shaft rotation, looking in direction "A" (see dimensional drawing)

Signal	Interface signals	Signal before differential generation At load 120 Ω	Signal offset
+ SIN - SIN + COS - COS	Analog, differential	0,5 V <sub>SS</sub> ± 20 %	2,5 V ± 10 %
Z Z <sub>-</sub>	Digital differential	Low: 1,75 V ± 15 %, High: 2,90 V ± 15 %	

Signal SIN/COS after differential generation

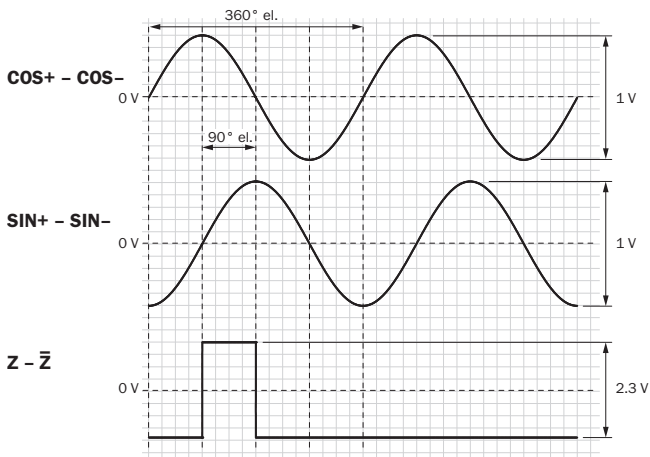



For clockwise shaft rotation, looking in direction "A" (see dimensional drawing)

Supply voltage	Output
4,5 V ... 5,5 V	Sin/Cos 1.0 V <sub>pp</sub>

Recommended accessories

Other models and accessories → [www.sick.com/DFS60S\\_Pro](http://www.sick.com/DFS60S_Pro)

	Brief description	Type	Part no.
Plug connectors and cables			
	Head A: female connector, M12, 8-pin, straight, A-coded Cable: Incremental, SSI, shielded	DOS-1208-GA01	6045001
	Head A: male connector, M12, 8-pin, straight, A-coded Cable: Incremental, shielded	STE-1208-GA01	6044892
	Head A: male connector, M23, 12-pin, straight Cable: HIPERFACE®, SSI, Incremental, shielded	STE-2312-G01	2077273

## SICK AT A GLANCE

SICK is one of the leading manufacturers of intelligent sensors and sensor solutions for industrial applications. A unique range of products and services creates the perfect basis for controlling processes securely and efficiently, protecting individuals from accidents and preventing damage to the environment.

We have extensive experience in a wide range of industries and understand their processes and requirements. With intelligent sensors, we can deliver exactly what our customers need. In application centers in Europe, Asia and North America, system solutions are tested and optimized in accordance with customer specifications. All this makes us a reliable supplier and development partner.

Comprehensive services complete our offering: SICK LifeTime Services provide support throughout the machine life cycle and ensure safety and productivity.

For us, that is “Sensor Intelligence.”

## WORLDWIDE PRESENCE:

Contacts and other locations –[www.sick.com](http://www.sick.com)