

# QR/P1 SERIES CONNECTOR

Small Rectangular Multi-electrode Solderless Connectors for Racks and Panels

## General

QR/P series connectors are small and compact high density versions of original OR/P series. Available in 8,

12, 16, 24 and 32 way. Crimps terminals assure positive and reliable termination with minimum labor.

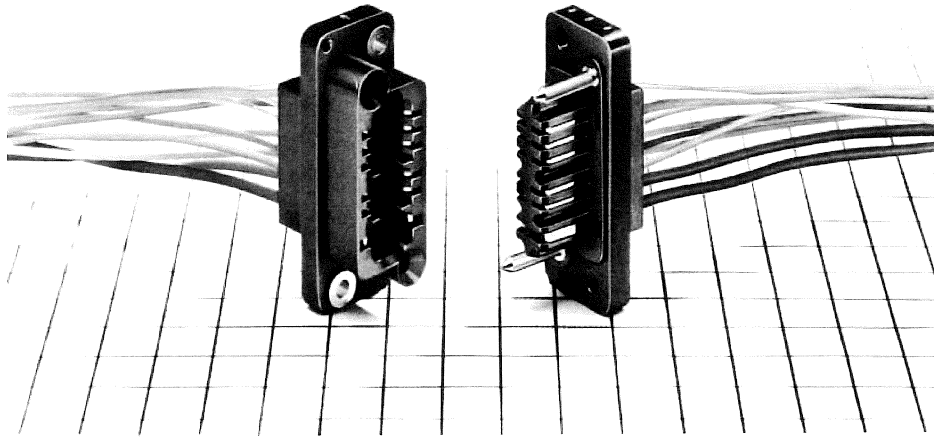

## Features

1. The coupling mechanism assures stable and reliable contact pressure through point and blade contact, in addition to smooth coupling that is sufficiently capable of dealing with variations in the coupling length specific to the plug-in connection.
2. Compact contacts due to separate power contacts from signal contacts.
3. One opposed pair (in 12 contacts), 2 pairs (in 8, 16, and 24 contacts), and 3 pairs (in 32 contacts) can be used as power supply contacts. They are spaced further apart than the others so as to have enough creeping distance to withstand a high voltage. Fire-retardant insulation materials (UL94-0) are used.
4. The Guide Pin is made of steel nickel plated to be strong enough against accidental coupling shock.
5. The mount of a receptacle housing is done through Floating Bushes. Thus, they may help to give more smooth coupling of connectors by self-adjusting function.

## Application

PPC, Transmission and reception equipment, Data Communication, Vending Machine, Measuring Instruments, Automatic Equipment, Switchboards, etc.

The product information in this catalog is for reference only. Please request the Engineering Drawing for the most current and accurate design information.

All non-RoHS products have been discontinued, or will be discontinued soon. Please check the products status on the Hirose website RoHS search at [www.hirose-connectors.com](http://www.hirose-connectors.com), or contact your Hirose sales representative.

## How To Use Connectors

General rating of QR/P1		
Contact resistance	Power unit	10m Ω or less at DC1A
	Signal unit	10m Ω or less at DC1A
Insulation resistance	5000M Ω higher at DV 500V	
Withstand voltage (for 1 min.)	Power terminal	AC 1000V
	Signal terminal	AC 500V
Rated current	Power unit	13Amax (AWG #14 use)
	Signal unit	3A
Rated voltage	Power terminal	AC 250V
	Signal terminal	AC 125V

Material		
Insulator	Polyethylene terephthalate	Black
Terminal	Phosphor bronze	Selective gold plating with nickel underplating

Ratings authorized by QR/P1 safety standards							
Safety standard		UL	CSA	TÜV			
Operating temperature range		- 10 ~ + 60°C					
Rated voltage	Power supply	AC120V	AC250V	AC125V	AC250V	AC250, DC300V	
	Signal unit					AC125, DC150V	
Rated current	AWG#14	10A	3A	10A	3A	10A	
	AWG#16			8A			
	AWG#18	3A	1A	3A	1A	5A	
	AWG#20					2.5A	
	AWG#22					1A	
	AWG #24	Power supply	2A	1A	2A		1A
		Signal unit	1A	0.5A	1A		0.5A
AWG#26	1A	0.5A	1A	0.5A	—		
AWG#28							

## Ordering Information

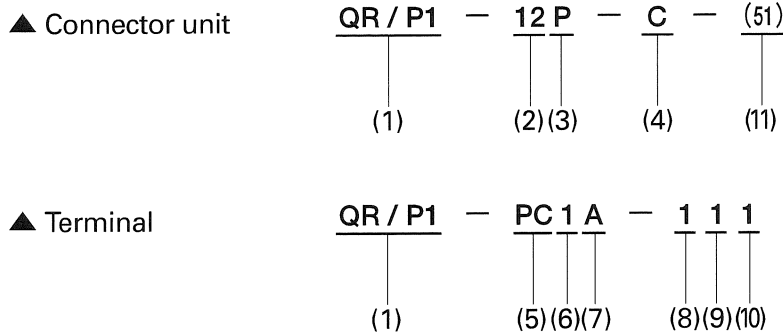

- (1) Series name
- (2) No. of contacts (8, 12, 16, 24, 32)
- (3) Shape of insulator mating part  
P: Insulator male case  
S: Insulator female case
- (4) Type of termination  
C: Crimp terminal
- (5) Male/ Female  
PC: Male crimp terminal  
SC: Female crimp terminal
- (6) Type  
1: Power terminal  
2: Signal terminal

- (7) Crimp barrel size  
A: For thin wires  
B: For thick wires
- (8) Shape  
1: Loose piece terminal  
2: Strip terminal
- (9) Applicable wire  
1: Power terminal AWG # 18 - # 24  
Signal terminal AWG # 24 - # 28  
2: Power terminal AWG # 14 - # 16  
Signal terminal AWG # 20 - # 24
- (10) Surface terminal  
1: Selective gold plating with nickel underplating
- (11) Specifications meeting UL, CSA TÜV requirements

The product information in this catalog is for reference only. Please request the Engineering Drawing for the most current and accurate design information.  
 All non-RoHS products have been discontinued, or will be discontinued soon. Please check the products status on the Hirose website RoHS search at [www.hirose-connectors.com](http://www.hirose-connectors.com), or contact your Hirose sales representative.

## Contacts for thick wire Contact Configuration

Male Housing (Viewed from Wiring Side)

■: indicates a contact hole for thick wire

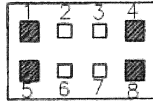

QR/P1-8P-C (51)

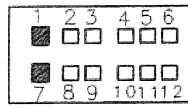

QR/P1-12P-C (51)

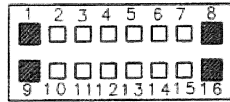

QR/P1-16P-C (51)

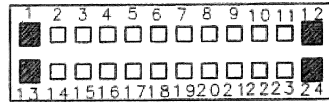

QR/P1-24P-C (51)



QR/P1-32P-C (51)

The product information in this catalog is for reference only. Please request the Engineering Drawing for the most current and accurate design information.  
 All non-RoHS products have been discontinued, or will be discontinued soon. Please check the products status on the Hirose website RoHS search at [www.hirose-connectors.com](http://www.hirose-connectors.com), or contact your Hirose sales representative.

## Housing

Plug Housing

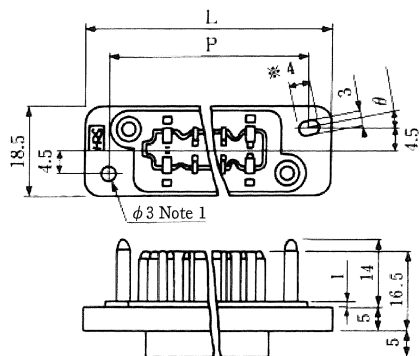
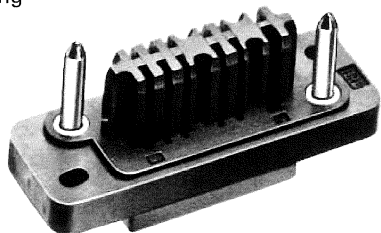

Unit: mm

HRS No.	No. of Pin	Part No.	L	P	$\theta$	RoHS
CL221-0124-0-51	8	QR/P1- 8P-C (51)	46.4	36.9	13.7°	○
CL221-0100-2-51	12	QR/P1-12P-C (51)	51	42	12.1°	
CL221-0110-6-51	16	QR/P1-16P-C (51)	57.6	48.1	10.6°	
CL221-0112-1-51	24	QR/P1-24P-C (51)	68.8	59.3	8.6°	
CL221-0131-6-51	32	QR/P1-32P-C (51)	85.5	76.0	6°	

Socket Housing

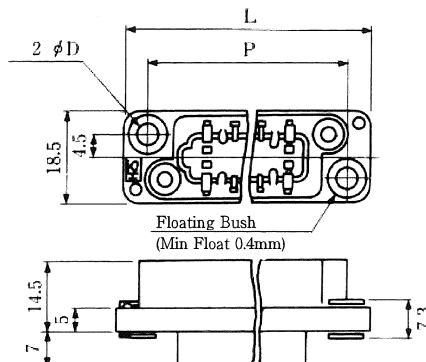
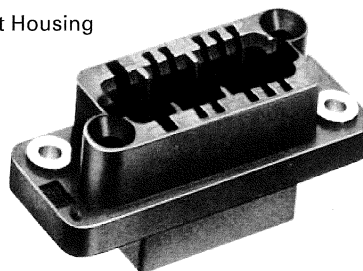

Unit: mm

HRS No.	No. of Pin	Part No.	L	P	D	RoHS
CL221-0125-3-51	8	QR/P1- 8S-C (51)	46.4	36.9	4.3	○
CL221-0101-5-51	12	QR/P1-12S-C (51)	51	42	3.3	
CL221-0111-9-51	16	QR/P1-16S-C (51)	57.6	48.1	4.3	
CL221-0113-4-51	24	QR/P1-24S-C (51)	68.8	59.3	4.3	
CL221-0132-9-51	32	QR/P1-32S-C (51)	85.5	76.0	4.3	

Note: Determine the combinations with the panel so that the mating clearance between the P side and S side is 1.5mm or less.

## Crimp Contact (Power Circuit)

Male Contact

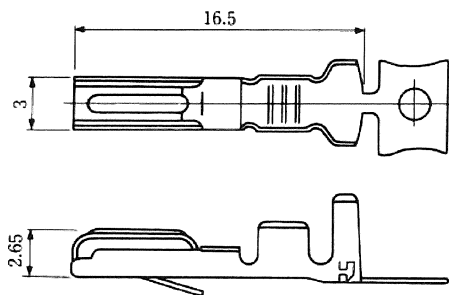

Plating: Partly gold plated over nickel plating

Applicable Wire	HRS No.	Part No.	Type	Packing	RoHS
AWG#14~16	CL221-0114-7-12	QR/P1-PC1B-121 (12)	Loose contact	100pin	○
	CL221-0118-8-12	QR/P1-PC1B-221 (12)	Chain contact	3,000pin	
AWG#18~24	CL221-0102-8-12	QR/P1-PC1A-111 (12)	Loose contact	100pin	
	CL221-0106-9-12	QR/P1-PC1A-211 (12)	Chain contact	5,000pin	

Female Contact

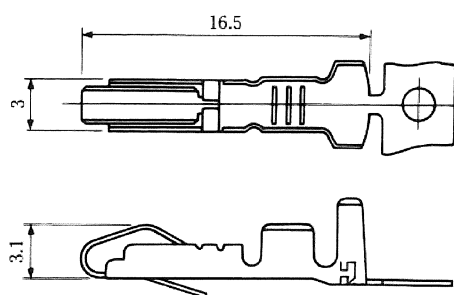

Plating: Partly gold plated over nickel plating

Applicable Wire	HRS No.	Part No.	Type	Packing	RoHS
AWG#14~16	CL221-0116-2-12	QR/P1-SC1B-121 (12)	Loose contact	100pin	○
	CL221-0120-0-12	QR/P1-SC1B-122 (12)	Chain contact	3,000pin	
AWG#18~24	CL221-0104-3-12	QR/P1-SC1A-111 (12)	Loose contact	100pin	
	CL221-0108-4-12	QR/P1-SC1A-211 (12)	Chain contact	5,000pin	

## Crimp Contact (Signal Circuit)

Male Contact

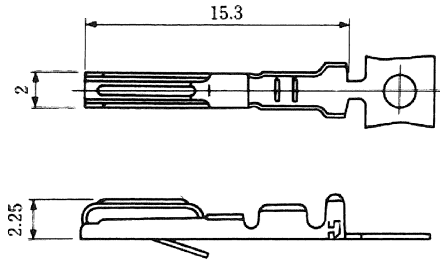

Female Contact

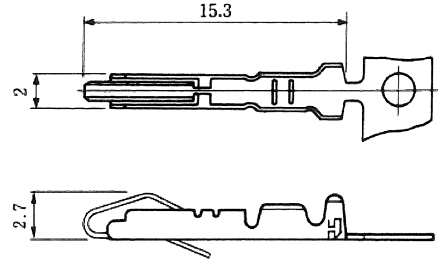

Plated: Gold plated over nickel plating

Applicable Wire	HRS No.	Part No.	Type	Packing	RoHS
AWG#20 ~ 24	CL221-0115-0-12	QR/P1-PC2B-121 (12)	Loose contact	100pin	○
	CL221-0119-0-12	QR/P1-PC2B-221 (12)	Chain contact	3,000pin	
AWG#24 ~ 28	CL221-0103-0-12	QR/P1-PC2A-111 (12)	Loose contact	100pin	○
	CL221-0107-1-12	QR/P1-PC2A-211 (12)	Chain contact	5,000pin	

Plated: Gold plated over nickel plating

Applicable Wire	HRS No.	Part No.	Type	Packing	RoHS
AWG#20 ~ 24	CL221-0117-5-12	QR/P1-SC2B-121 (12)	Loose contact	100pin	○
	CL221-0121-2-12	QR/P1-SC2B-122 (12)	Chain contact	3,000pin	
AWG#24 ~ 28	CL221-0105-6-12	QR/P1-SC2A-111 (12)	Loose contact	100pin	○
	CL221-0109-7-12	QR/P1-SC2A-211 (12)	Chain contact	5,000pin	

## Recommended Mounting Hole

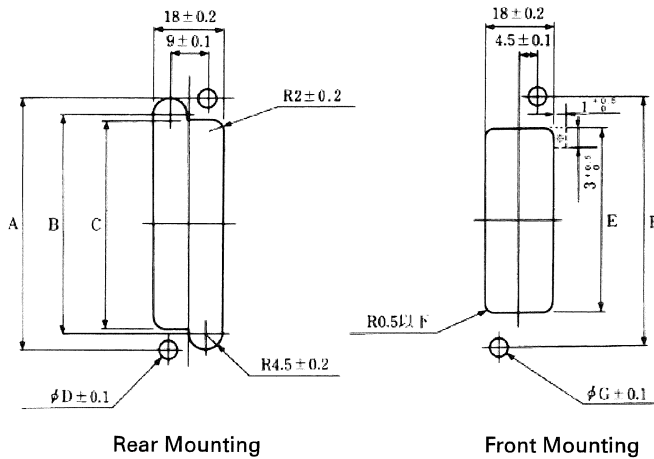

No. of pin		8 Pin	12 Pin	16 Pin	24 Pin	32 Pin
Rear Mounting	A	36.9	42	48.1	59.3	76
	B	29.4	34.5	40.6	51.8	68.5
	C	28.4	33.5	39.6	50.8	67.5
	D	4.3	3.3	4.3	4.3	4.3
Front Mounting	E	22.4	27.5	33.6	44.8	61
	F	36.9	42	48.1	59.3	76
	G	4.3	3.3	4.3	4.3	4.3

Note: Panel mounting dimensions for the P insulation case are symmetrical with request to the vertical axis, in relation to the S insulation case.

## Applicable Tools

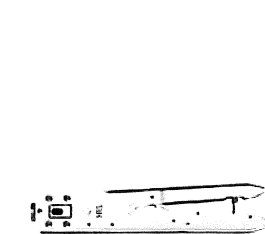

Hand crimping

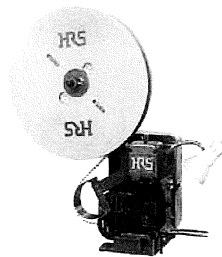

Automatic crimping machine  
CM-105  
CL901-0054-4

Type	HRS No.	Part No.	Applicator terminay
Hand Crimp Tool	CL250-0020-0	TC-QR/P1-PC1B	QR/P1-PC1B-121
	CL250-0015-0	TC-QR/P1-PC1A	QR/P1-PC1A-111
	CL250-0022-6	TC-QR/P1-SC1B	QR/P1-SC1B-121
	CL250-0017-6	TC-QR/P1-SC1A	QR/P1-SC1A-111
	CL250-0021-3	TC-QR/P1-PC2B	QR/P1-PC2B-121
	CL250-0016-3	TC-QR/P1-PC2A	QR/P1-PC2A-111
	CL250-0023-9	TC-QR/P1-SC2B	QR/P1-SC2B-121
	CL250-0018-9	TC-QR/P1-SC2A	QR/P1-SC2A-111
Auto Crimp Machine Applicator	CL901-2529-06	AP105-QR/P1-1B-2	QR/P1-PC1B-221 QR/P1-SC1B-221
	CL901-2530-5	AP105-QR/P1-2B-2	QR/P1-PC2B-221 QR/P1-SC2B-221
	CL901-2527-0	AP105-QR/P1-1A-1	QR/P1-PC1A-211 QR/P1-SC1A-211
	CL901-2528-3	AP105-QR/P1-2A-1	QR/P1-PC2A-211 QR/P1-SC2A-211
Hand Tool	CL250-0019-1	TC-QR/P1-21	

# Mouser Electronics

Authorized Distributor

Click to View Pricing, Inventory, Delivery & Lifecycle Information:

[Hirose Electric:](#)

[QR/P1-8PA-C\(51\)](#) [QR/P1-12PB-C\(51\)](#) [QR/P1-16SB-C\(51\)](#) [QR/P11-8P-DS\(59\)](#) [QR/P11-8S-C](#)