

SAMZO REAC/ROHS

REV	ECN NO	DESCRIPTION	DESIGN	APPROVAL	DATE
A1	NEW	Replace frame			2018.06.15

主要技术参数、性能
The Main Thchnology Performance

额定电流、电压 Rate voltage, current	50mA DC12V
接触电阻 Contact resistance	≤100mΩ
按力 Operating force	±50gf
行程 Travel	0.20±0.10mm
绝缘电阻 Insulated resistance	≥100MΩ
介电强度 Dielectric strength	≥250VAC/1min

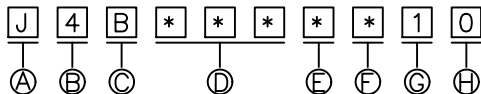
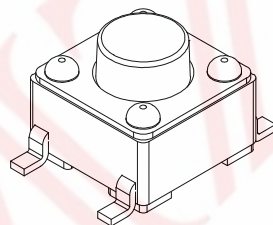
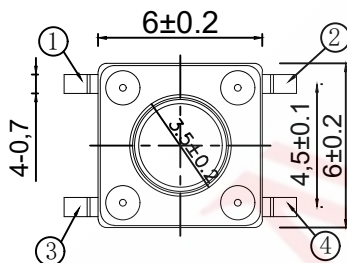
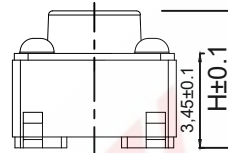
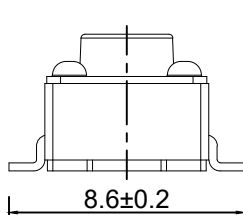
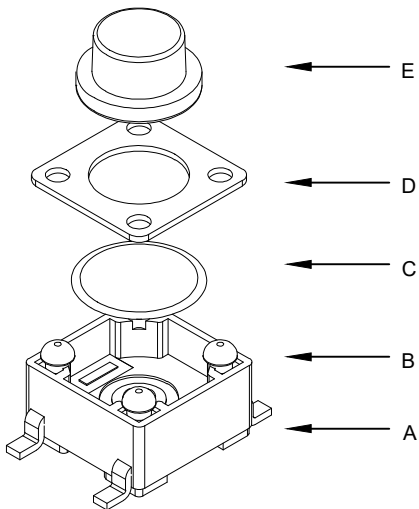

- A. 系列: J-6*6mm系列
- B. 贴装方式: 4-立式贴片
- C. 规格: B-4P
- D. 操作高度: 043-4.3mm/060-6.0mm/115-11.5mm/210-21.0mm/(4.3-25.0)
- E. 操作力度: 1-120gf/2-180gf/3-260gf/4-350gf
- F. 操作寿命: 1-100,000次/2-500,000次/3-1,000,000次
- G. 固定方式: 1-无柱
- H. 物料编码: 0-常规(确认待编)

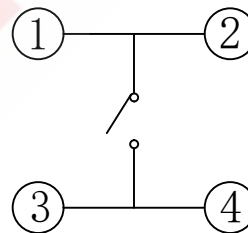

电路图
CIRCUIT DIAGRAM

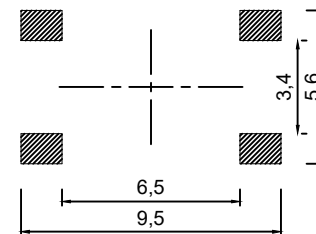

PCB. 焊接图
PCB. WELDING DRAWING

ITEM	DESCRIPTION	MATERIAL	QTY	FINISH/COLOR					
E	Button	BRASS	1	Pickling					
D	Cover plate	SUS/201	1	Clean	GENERAL TOLERANCE				
C	Shrapnel	SUS/301	1	Silver plating	≥0~2<	±0.15			
B	Subject	PPA	1	Black	DESIGN	WANGGUIFA	2018.06.12	≥2~5<	±0.25
A	Card	Phosphorous copper	1	Silver plating	CHECKED	ZHENGUILAN	2018.06.12	≥0~2<	±0.15
					APPROVED	LILIANJIANG	2018.06.14	≥5	±0.35

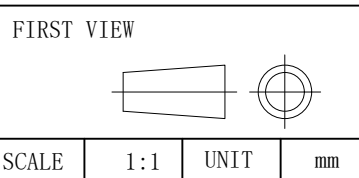

The copyright belongs to samzo parts [China] Co., Ltd. please use the material after samzo parts agree to authorize. The final right of interpretation belongs to samzo parts.
WWW.KKK-JP.COM

TITLE: 6.0*6.0*H mm 4P-LT

DWG NO: J4BXXX-1806-P39

PART NO: J4BXXX1806

MODEL NO: J4B-***-**-10

NAME: TACT SWITCH

SAMZO COMPONENTS
Electronic switch and connector manufacturer