

DESCRIPTION

The small size and low power consumption (34µA per channel maximum) of the OPA347 make it ideal for portable and battery-powered applications. The input range of the OPA347 extends 200mV beyond the rails, and the output range is within 5mV of the rails. The OPA347 also features an excellent speed/power ratio with a bandwidth of 350kHz.

The OPA347 can be operated with a single or dual power supply from 2.3V to 5.5V. All models are specified for operation from -55°C to +125°C.

FEATURES

- LOW I_Q: 20µA
- HIGH SPEED/POWER RATIO WITH BANDWIDTH: 350kHz
- RAIL-TO-RAIL INPUT AND OUTPUT
- SINGLE SUPPLY: 2.3V to 5.5V

APPLICATIONS

- PORTABLE EQUIPMENT
- BATTERY-POWERED EQUIPMENT
- 2-WIRE TRANSMITTERS
- SMOKE DETECTORS
- CO DETECTORS

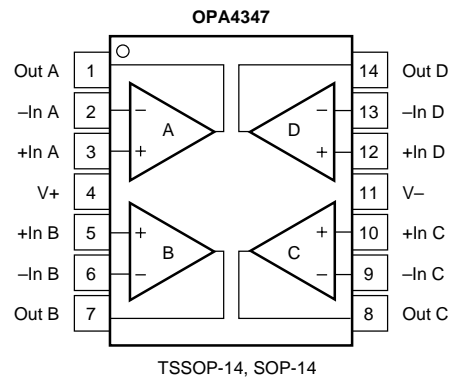
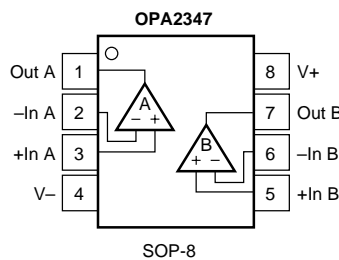
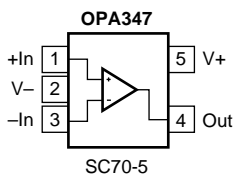

microPower, Rail-to-Rail Operational Amplifiers

ELECTRICAL CHARACTERISTICS: $V_S = 2.5V$ to $5.5V$

Boldface limits apply over the specified temperature range, $T_A = -55^\circ C$ to $+125^\circ C$.

At $T_A = +25^\circ C$, $R_L = 100k\Omega$ connected to $V_S/2$ and $V_{OUT} = V_S/2$, unless otherwise noted.

PARAMETER	CONDITION	OPA347SA OPA2347UA, OPA4347EA, UA			UNITS
		MIN	TYP	MAX	
Input Offset Voltage	V_{OS}	$V_S = 5.5V, V_{CM} = (V-) + 0.8V$	2	6	mV
over Temperature			2	7	mV
Drift	dV_{OS}/dT		3		$\mu V/^\circ C$
vs Power Supply	PSRR	$V_S = 2.5V$ to $5.5V, V_{CM} < (V+) - 1.7V$	60	175	$\mu V/V$
over Temperature		$V_S = 2.5V$ to $5.5V, V_{CM} < (V+) - 1.7V$		300	$\mu V/V$
Channel Separation, DC			0.3		$\mu V/V$
	$f = 1kHz$		128		dB
Common-Mode Voltage Range	V_{CM}		$(V-) - 0.2$	$(V+) + 0.2$	V
Common-Mode Rejection Ratio	CMRR	$V_S = 5.5V, (V-) - 0.2V < V_{CM} < (V+) - 1.7V$	70	80	dB
over Temperature		$V_S = 5.5V, (V-) - 0.2V < V_{CM} < (V+) - 1.7V$	66		dB
		$V_S = 5.5V, (V-) - 0.2V < V_{CM} < (V+) + 0.2V$	54	70	dB
over Temperature		$V_S = 5.5V, (V-) - 0.2V < V_{CM} < (V+) + 0.2V$	48		dB
Input Bias Current	I_b		± 0.5	± 10	pA
Input Offset Current	I_{OS}		± 0.5	± 10	pA
Differential			$10^{13} \parallel 3$		$\Omega \parallel pF$
Common-Mode			$10^{13} \parallel 6$		$\Omega \parallel pF$
NOISE		$V_{CM} < (V+) - 1.7V$			
Input Voltage Noise, $f = 0.1Hz$ to $10Hz$			12		μV_{PP}
Input Voltage Noise Density, $f = 1kHz$	e_n		60		nV/\sqrt{Hz}
Input Current Noise Density, $f = 1kHz$	i_n		0.7		fA/\sqrt{Hz}
Open-Loop Voltage Gain	A_{OL}	$V_S = 5.5V, R_L = 100k\Omega, 0.015V < V_O < 5.485V$	100	115	dB
over Temperature		$V_S = 5.5V, R_L = 100k\Omega, 0.015V < V_O < 5.485V$	88		dB
		$V_S = 5.5V, R_L = 5k\Omega, 0.125V < V_O < 5.375V$	100	115	dB
over Temperature		$V_S = 5.5V, R_L = 5k\Omega, 0.125V < V_O < 5.375V$	88		dB
	$A_{OL} (SC-70 \text{ only})$	$V_S = 5.5V, R_L = 5k\Omega, 0.125V < V_O < 5.375V$	96	115	dB
Voltage Output Swing from Rail		$R_L = 100k\Omega, A_{OL} > 100dB$	5	15	mV
over Temperature		$R_L = 100k\Omega, A_{OL} > 88dB$		15	mV
		$R_L = 5k\Omega, A_{OL} > 100dB$	90	125	mV
over Temperature		$R_L = 5k\Omega, A_{OL} > 88dB$		125	mV
Short-Circuit Current	I_{SC}		± 17		mA
Capacitive Load Drive	C_{LOAD}		See Typical Characteristics		
FREQUENCY RESPONSE		$C_L = 100pF$			
Gain-Bandwidth Product	GBW		350		kHz
Slew Rate	SR	$G = +1$	0.17		$V/\mu s$
Settling Time, 0.1%	t_S	$V_S = 5V, 2V \text{ Step}, G = +1$	21		μs
0.01%		$V_S = 5V, 2V \text{ Step}, G = +1$	27		μs
Overload Recovery Time		$V_{IN} \times \text{Gain} = V_S$	23		μs
Specified Voltage Range	V_S		2.5	5.5	V
Minimum Operating Voltage			2.3		V
Minimum Operating Voltage (OPA347SA)			2.4		V
Quiescent Current (per amplifier)	I_Q	$I_O = 0$	20	34	μA
over Temperature				38	μA
Specified Range			-55	125	$^\circ C$
Operating Range			-65	150	$^\circ C$
Storage Range			-65	150	$^\circ C$
Thermal Resistance	θ_{JA}				
SOT23-5 Surface-Mount			200		$^\circ C/W$
SOT23-8 Surface-Mount			150		$^\circ C/W$
SO-8 Surface-Mount			150		$^\circ C/W$
SO-14 Surface-Mount			100		$^\circ C/W$
TSSOP-14 Surface-Mount			100		$^\circ C/W$
DIP-8			100		$^\circ C/W$
SC70-5 Surface-Mount			250		$^\circ C/W$
WCSP			250		$^\circ C/W$

TYPICAL CHARACTERISTICS

At $T_A = +25^\circ\text{C}$, $V_S = +5\text{V}$, and $R_L = 100\text{k}\Omega$ connected to $V_S/2$, unless otherwise noted.

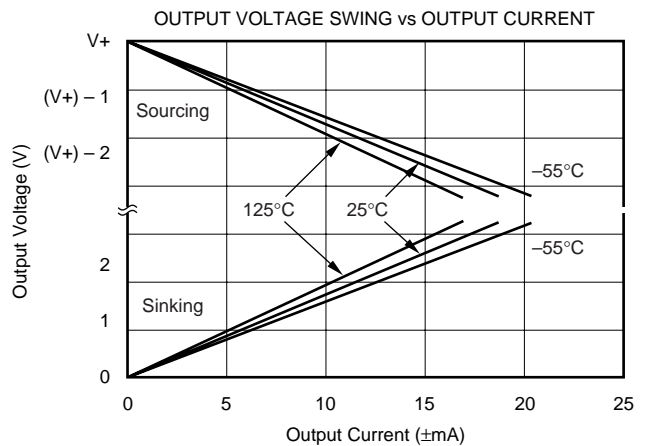
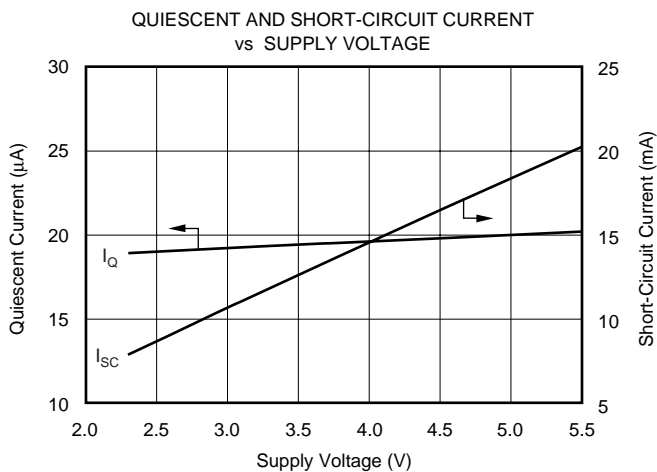
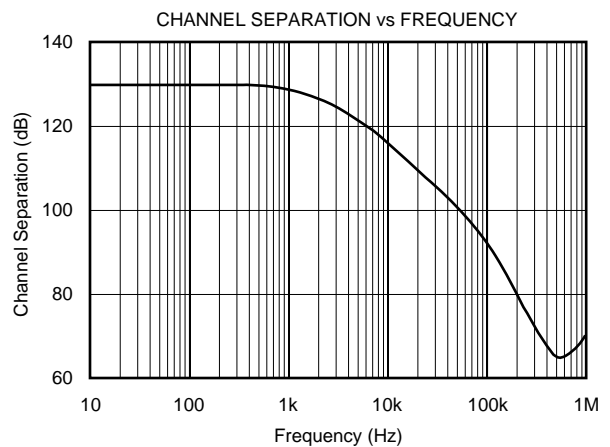
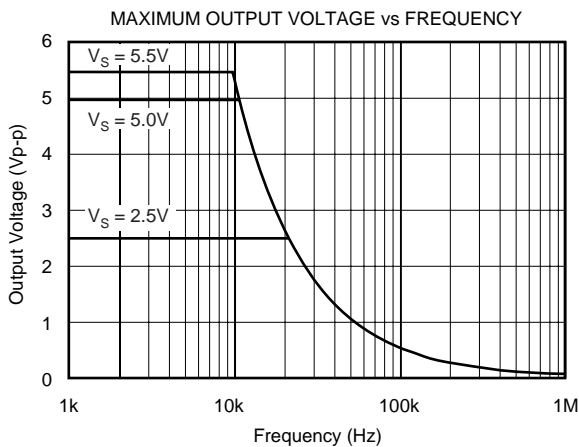
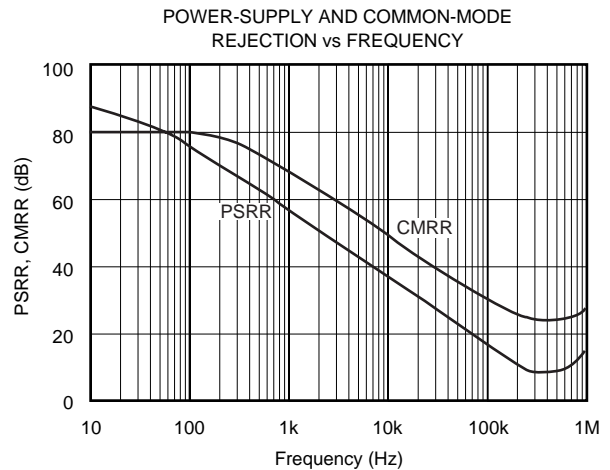
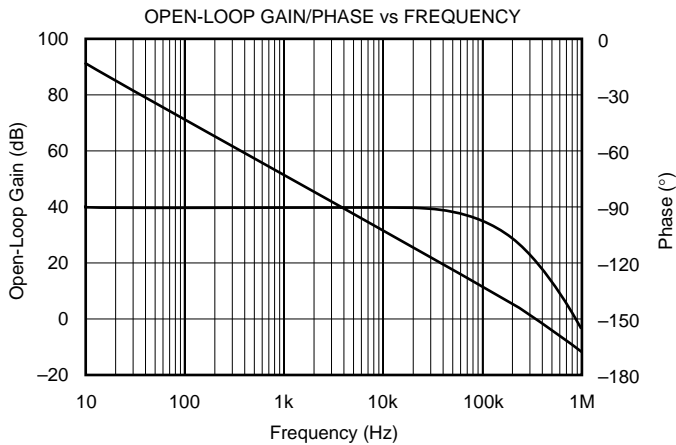

TYPICAL CHARACTERISTICS(Cont.)

At $T_A = +25^\circ\text{C}$, $V_S = +5\text{V}$, and $R_L = 100\text{k}\Omega$ connected to $V_S/2$, unless otherwise noted.

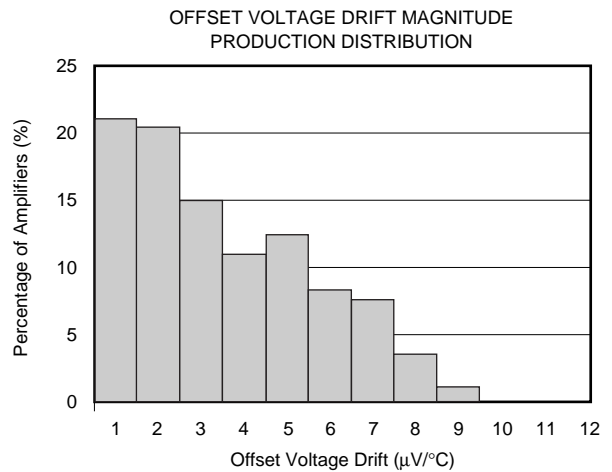
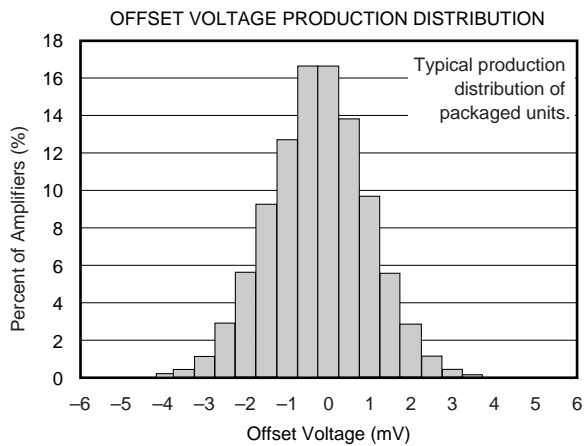
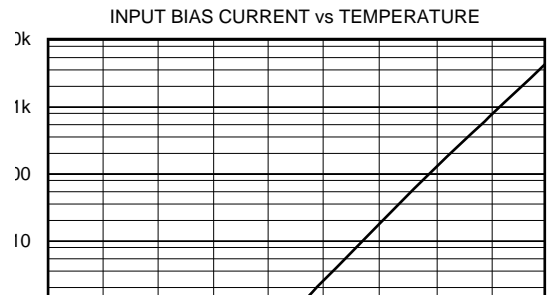
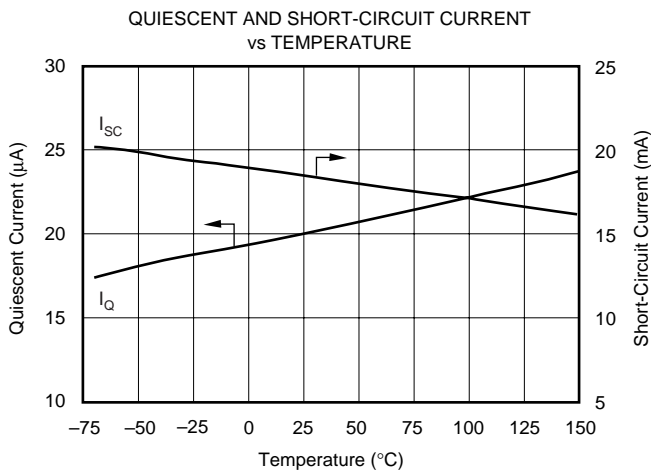
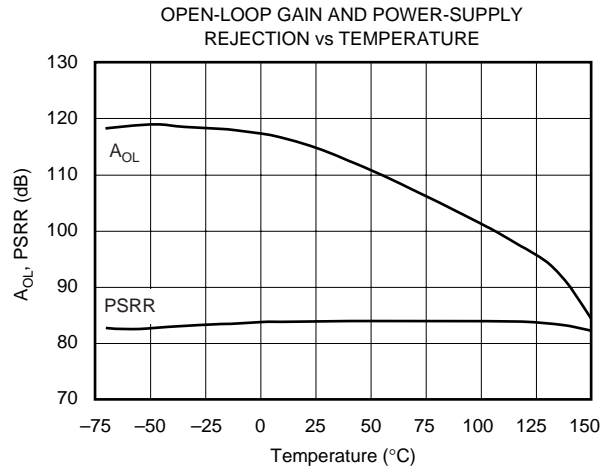
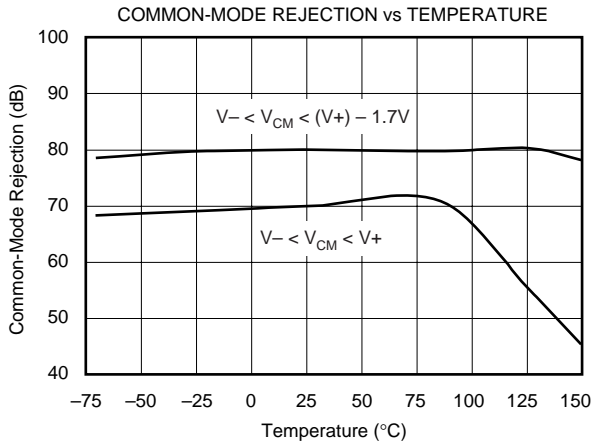

TYPICAL CHARACTERISTICS (Cont.)

At $T_A = +25^\circ\text{C}$, $V_S = +5\text{V}$, and $R_L = 100\text{k}\Omega$ connected to $V_S/2$, unless otherwise noted.

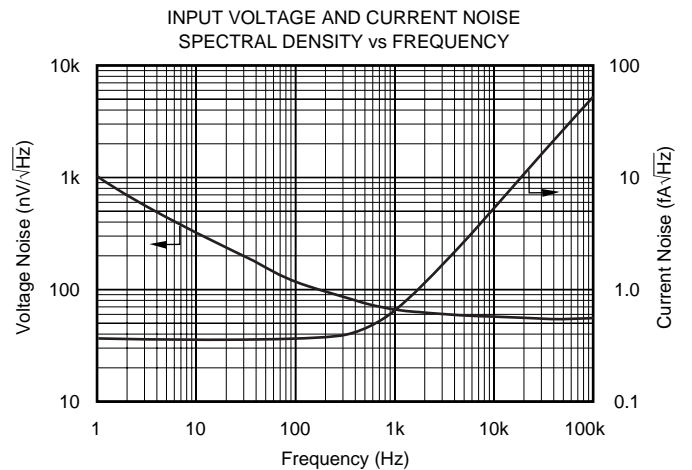
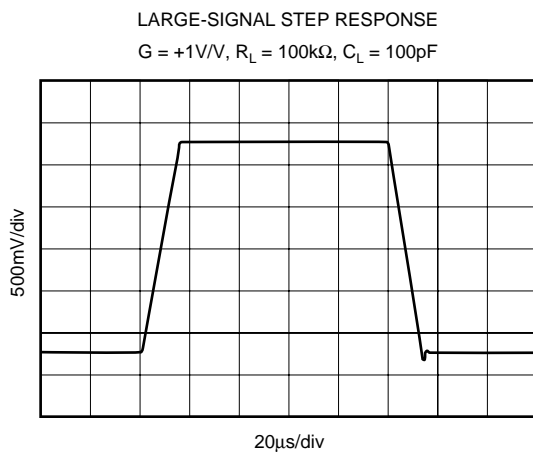
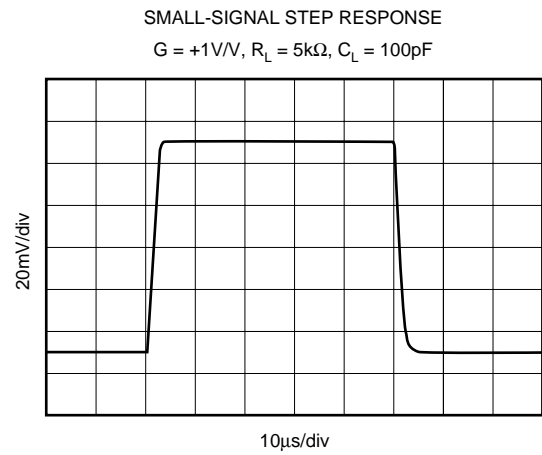
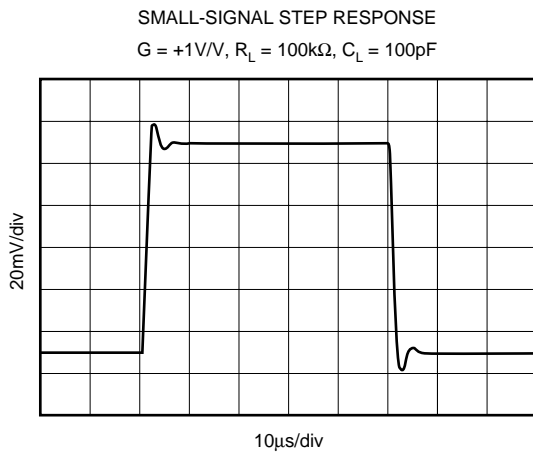
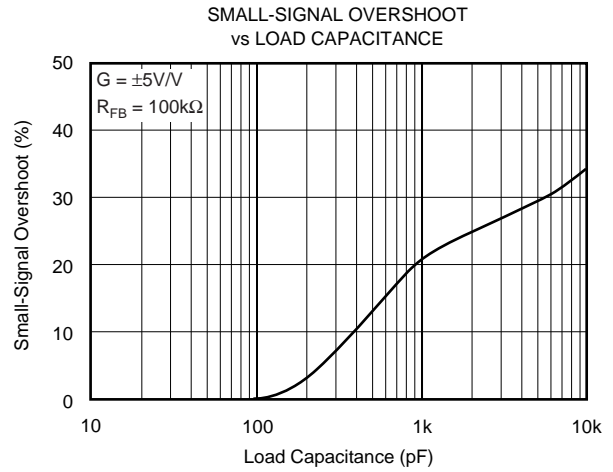
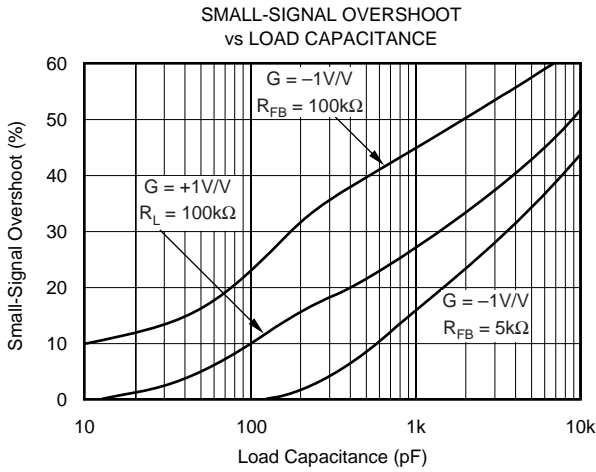

Package Dimension

SC70-5 (SOT353)

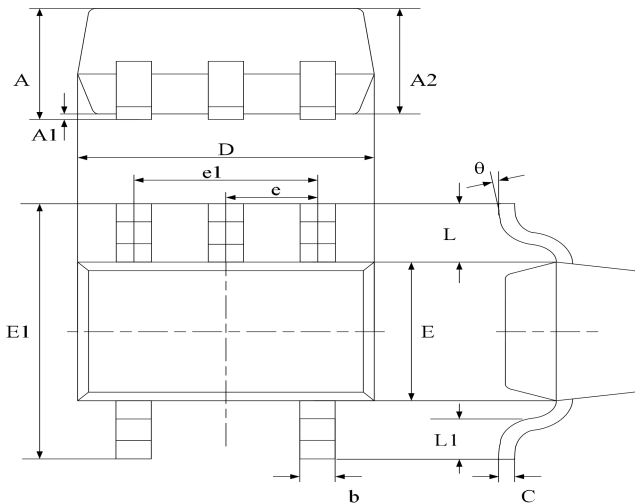

Symbol	Dimensions In Millimeters		Dimensions In Inches	
	Min	Max	Min	Max
A	0.800	1.100	0.035	0.043
A1	0.000	0.100	0.000	0.004
A2	0.800	0.900	0.035	0.039
b	0.150	0.350	0.006	0.014
C	0.080	0.150	0.003	0.006
D	1.8500	2.150	0.079	0.087
E	1.100	1.400	0.045	0.053
E1	1.950	2.200	0.085	0.096
e	0.850 typ.		0.026 typ.	
e1	1.200	1.400	0.047	0.055
L	0.42 ref.		0.021 ref.	
L1	0.260	0.460	0.010	0.018
theta	0°	8°	0°	8°

SOP-14

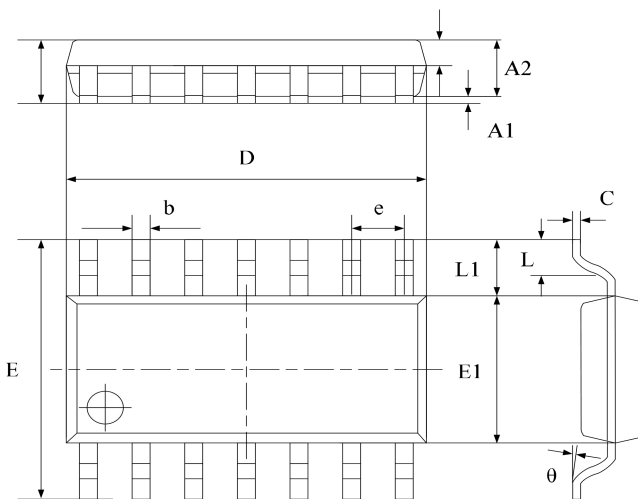

Symbol	Dimensions In Millimeters		Dimensions In Inches	
	Min	Max	Min	Max
A	1.450	1.850	0.059	0.076
A1	0.100	0.300	0.004	0.012
A2	1.350	1.550	0.055	0.063
A3	0.550	0.750	0.022	0.031
b	0.406typ.		0.017typ.	
C	0.203typ.		0.008typ.	
D	8.630	8.830	0.352	0.360
E	5.840	6.240	0.238	0.255
E1	3.850	4.050	0.157	0.165
e	1.270 typ.		0.050 typ.	
L1	1.040 ref.		0.041 ref.	
L	0.350	0.750	0.014	0.031
theta	2°	8°	2°	8°

SOP-8

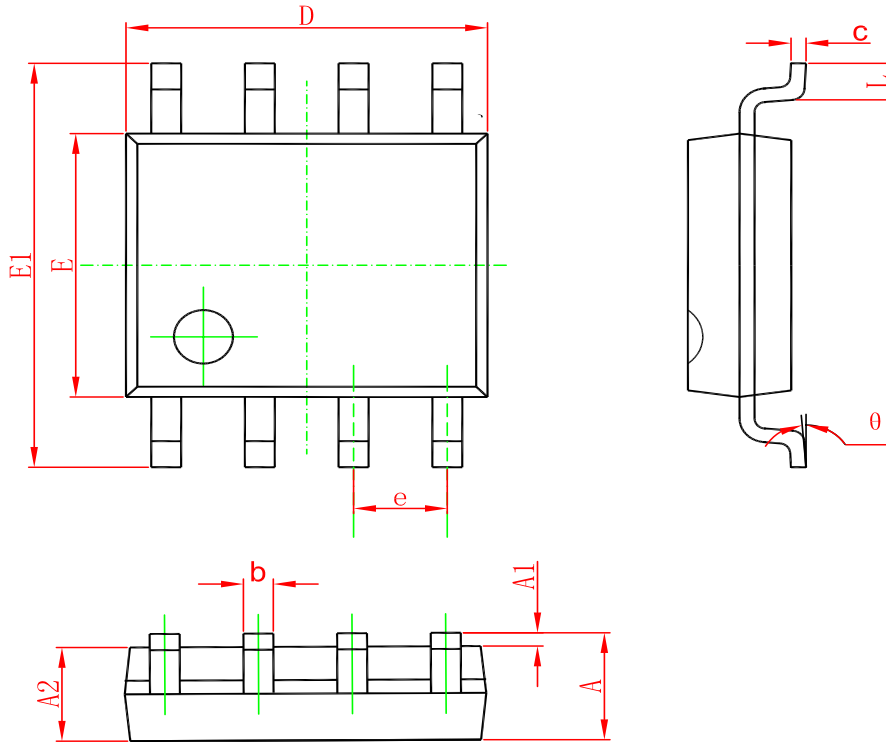

Symbol	Dimensions In Millimeters		Dimensions In Inches	
	Min	Max	Min	Max
A	1.350	1.750	0.053	0.069
A1	0.100	0.250	0.004	0.010
A2	1.350	1.550	0.053	0.061
b	0.330	0.510	0.013	0.020
c	0.170	0.250	0.006	0.010
D	4.700	5.100	0.185	0.200
E	3.800	4.000	0.150	0.157
E1	5.800	6.200	0.228	0.244
e	1.270(BSC)		0.050(BSC)	
L	0.400	1.270	0.016	0.050
θ	0°	8°	0°	8°

TSSOP-14

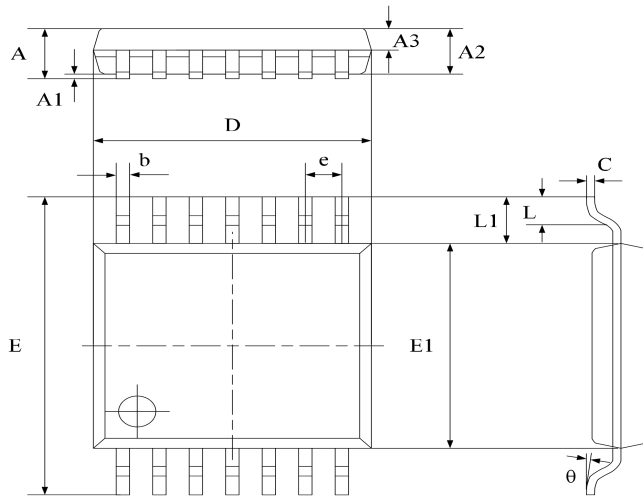

Symbol	Dimensions In Millimeters		Dimensions In Inches	
	Min	Max	Min	Max
A	-	1.200	-	0.0472
A1	0.050	0.150	0.002	0.006
A2	0.900	1.050	0.037	0.043
A3	0.390	0.490	0.016	0.020
b	0.200	0.290	0.008	0.012
C	0.130	0.180	0.005	0.007
D	4.860	5.060	0.198	0.207
E	6.200	6.600	0.253	0.269
E1	4.300	4.500	0.176	0.184
e	0.650 typ.		0.0256 typ.	
L1	1.000 ref.		0.0393 ref.	
L	0.450	0.750	0.018	0.031
θ	0°	8°	0°	8°

Ordering information

Order code	Package	Baseqty	Deliverymode	Marking
UMW OPA347SA	SC70-5	3000	Tape and reel	S47 U
UMW OPA4347UA	SOP-14	2500	Tape and reel	OPA4347UA
UMW OPA2347UA	SOP-8	2500	Tape and reel	OPA2347UA
UMW OPA4347EA	TSSOP-14	4000	Tape and reel	OPA4347EA