

The history of revision change for the specification

Document	REV.	Modified date	Description
CYNVC-214-010	A0	2021.4.12	New approval
CYNVC-214-010	A1	2021.12.22	1. Apr. -> Dec. 2. Add "AEC-Q200" logo 3. Add notice "AEC-Q200 qualified" in Features 4. Remove Notice "Preliminary specification" 5. Add R15 Spec and curve

Power Choke Coil VCMV063T MN2TM type

AEC-Q200

■ Features

High performance (Isat) realized by metal dust core.

Low profile : Thickness max. 3.0mm

Low loss realized with low DCR

Capable of corresponding high frequency

Compliance with RoHS and Halogen Free

AEC-Q200 qualified

■ Application

Automotive applications

■ Outline Dimensions

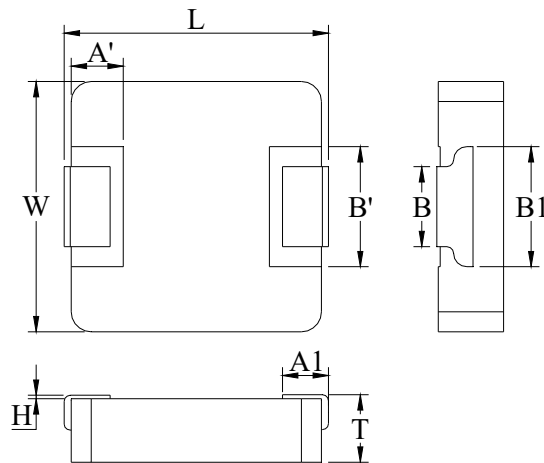

Code	Dimensions (mm)
L	6.95 ± 0.35
W	6.6 ± 0.2
T	2.8 ± 0.2
A1	1.27 ± 0.30
A'	2.0 ± 0.1
B	3.18 ± 0.30
B1	4.3 ± 0.3
B'	3.6 ± 0.2
H	$0 \sim +0.15$

■ Recommend Land Pattern Dimensions

The customer shall determine the land dimensions shown below after confirming and safety.

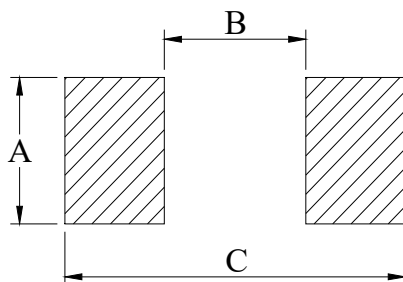

A	3.429
B	3.429
C	8.255

Unit : mm

■ Marking and Date Code

The point on the top surface represents winding direction of choke.

(1) Marking

The inductor is marked with a 3-digit code

Example -- 10.0 μ H → 100

(2) Date Code

X XX

(1) (2)

XXX

(3)

Where (1) Year Code

Ex : 2021 = 1

(2) Weekly Code

Serial number : 01 ~ 53

(3) Taping No.

Serial number : 001 ~ ZZZ

Upside of Chip

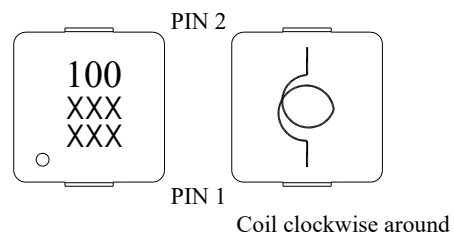

■ Specifications

Part Number	L0 ◇ Inductance (μH) @ (0A)	R _{dc} (mΩ) ◇		Heat Rating Current DC Amps. I _{dc} (A)		Saturation Current DC Amps. I _{sat} (A)		Rated Voltage (V)
		Typical	Maximum	Typical	Maximum	Typical	Maximum	Maximum
VCMV063T-R15MN2TM	0.15	1.7	2.0	33.0	29.7	52.0	45.0	75
VCMV063T-1R0MN2TM	1.0	9.2	11.0	11.6	10.4	22.0	18.9	75
VCMV063T-2R2MN2TM	2.2	16.6	19.9	8.7	7.8	14.0	12.0	75
VCMV063T-4R7MN2TM	4.7	37.0	44.0	5.8	5.2	10.5	9.0	75
VCMV063T-100MN2TM	10.0	81.0	97.2	3.9	3.5	6.3	5.4	75
VCMV063T-150MN2TM	15.0	116.0	139.2	3.3	3.0	4.5	3.9	75

◇ : Significant Characteristic

* : If you require another part number please contact with us.

** : Inductance Tolerance ± 20%

Note 1. : All test data is referenced to 25°C ambient.

Note 2. : Test Condition:100KHz, 1.0Vrms

Note 3. : I_{dc} : DC current (A) that will cause an approximate ΔT of 40°C

Note 4. : I_{sat} : DC current (A) that will cause L0 to drop approximately 20%

Note 5. : Operating Temperature Range -55°C to +125°C

Note 6. : The part temperature (ambient + temp rise) should not exceed 125°C under the worst case operating conditions. Circuit design, component placement, PCB trace size and thickness, airflow and other cooling provision all affect the part temperature. Part temperature should be verified in the end application.

Note 7. : The rated current as listed is either the saturation current or the heating current depending on which value is lower.

Note 8. : Cleaning Process Note

(a) If this power choke is dipped in the cleaning agent, such as toluene, xylene, ketone, and ether system, there is a possibility that the performance decreases greatly

(b) The high power ultrasonic washing may damage the choke body.

(c) Please contact us if you need the cleaning via the above agents or ultrasonic washing.

Current Characteristic

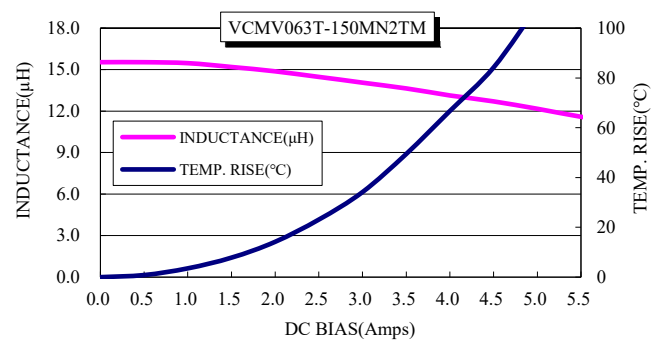
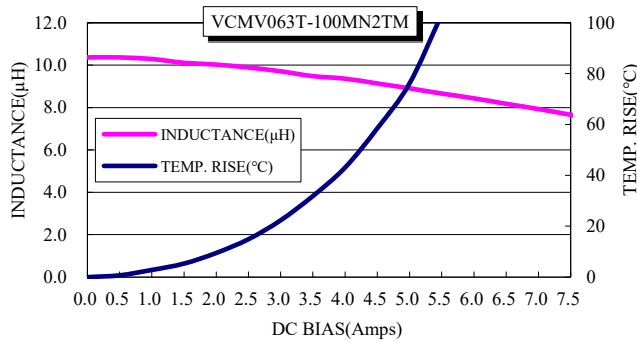
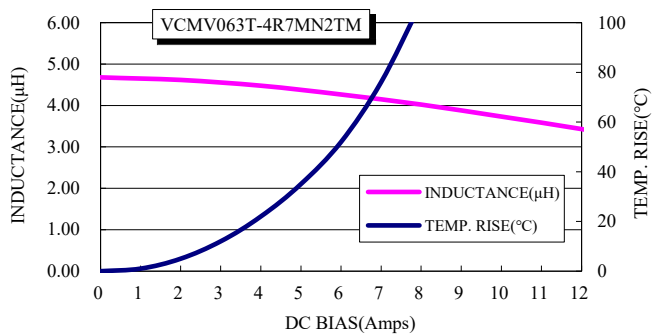
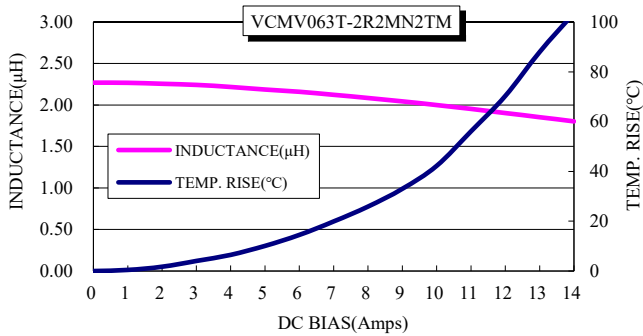
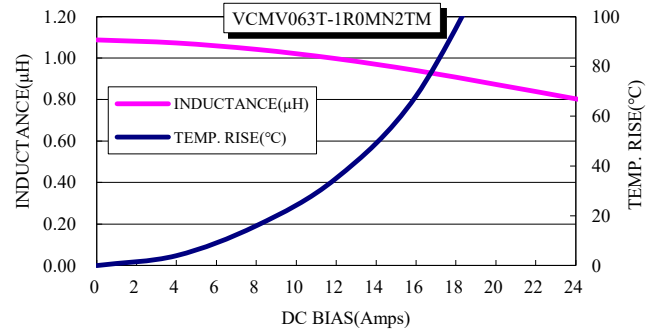
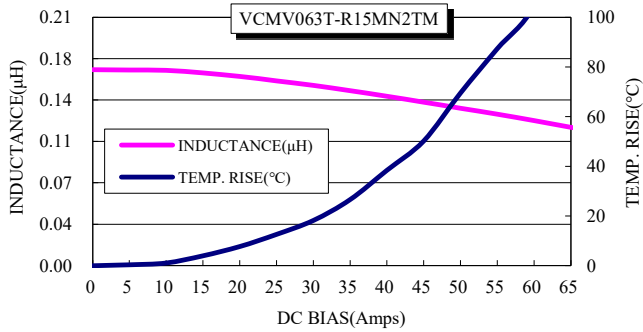

■ Packaging

(1) Tape packaging dimensions

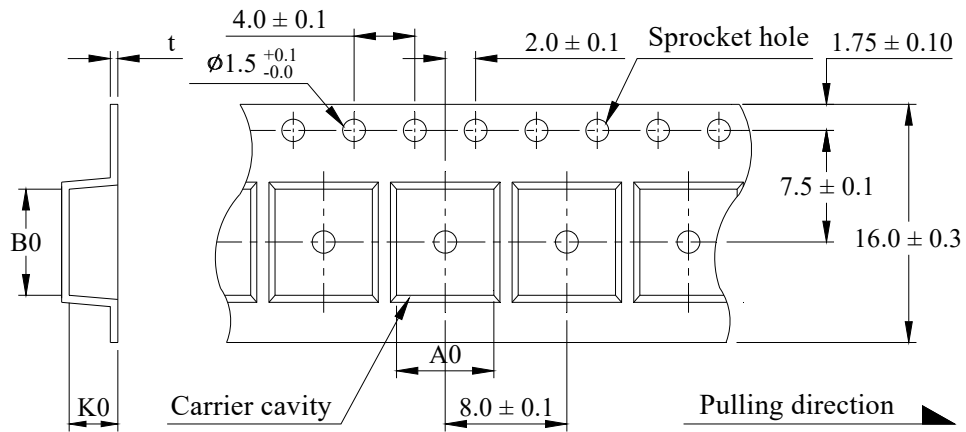

Dimensions Code (mm)				UNITS/REEL
A0	B0	K0	t	
7.10 ± 0.15	7.5 ± 0.1	3.6 ± 0.1	0.35 ± 0.05	2,000

(2) Tape Direction

The direction shall be seen from the top cover tape side.

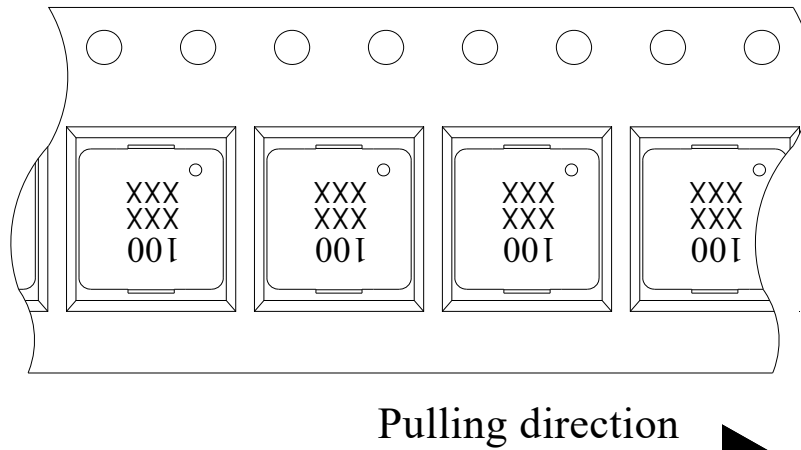

(3) Reel dimensions

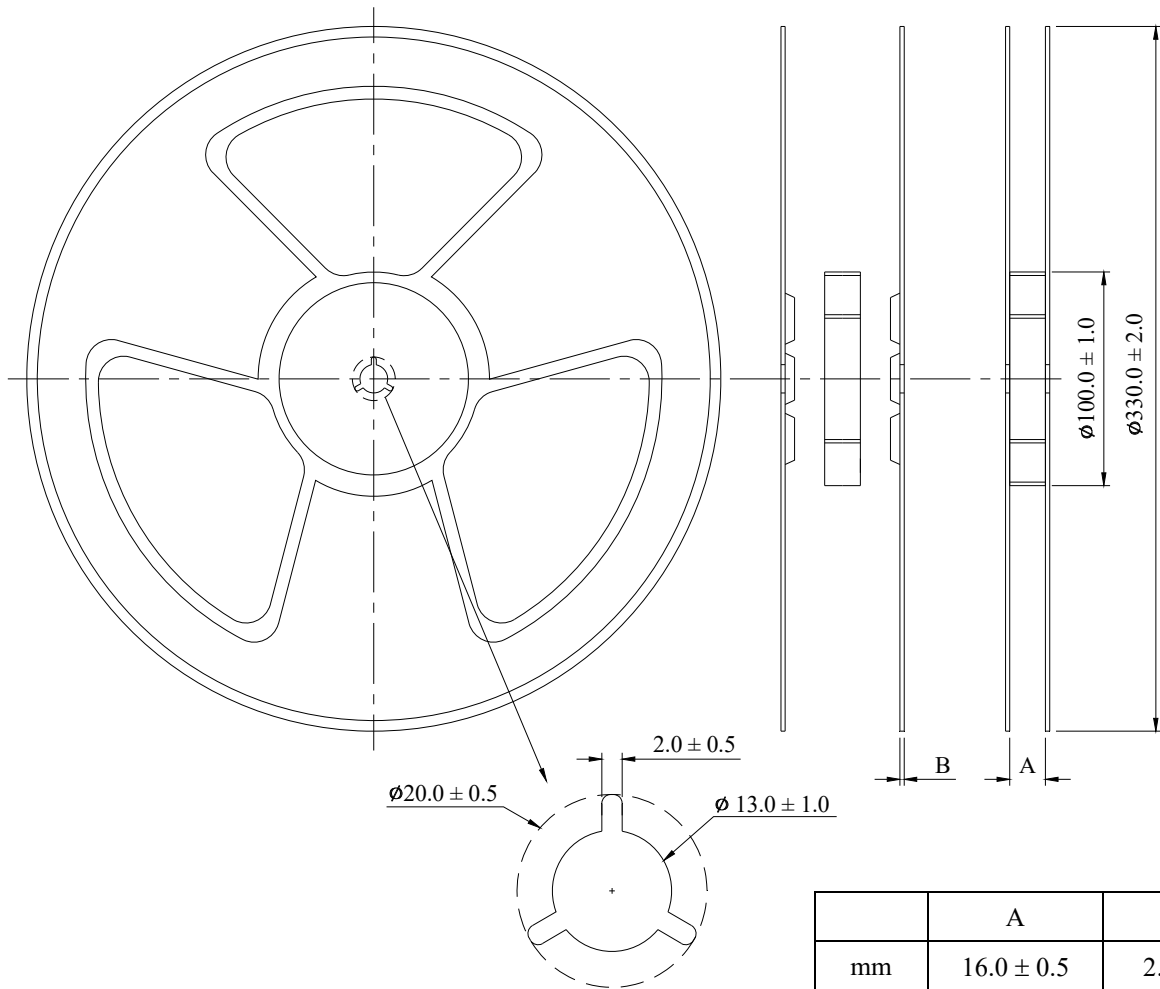

(4) Peel force of top cover tape

The peel speed shall be about 300 mm/minute.

The peel force of top cover tape shall be between 0.1 to 1.3N.

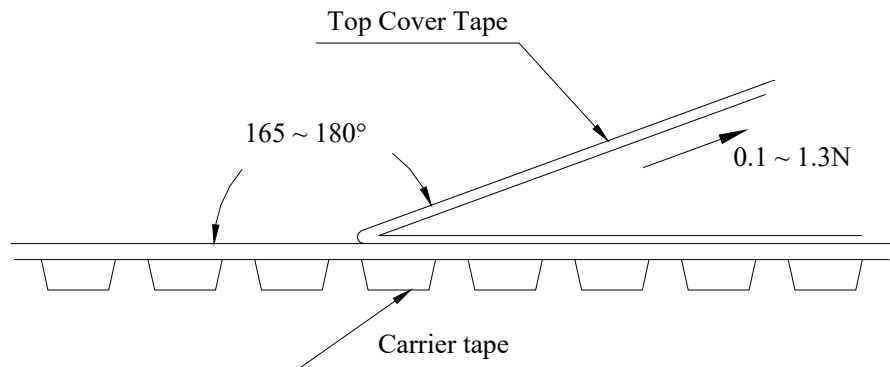

■ Reflow Profile

Power Choke Coil Type

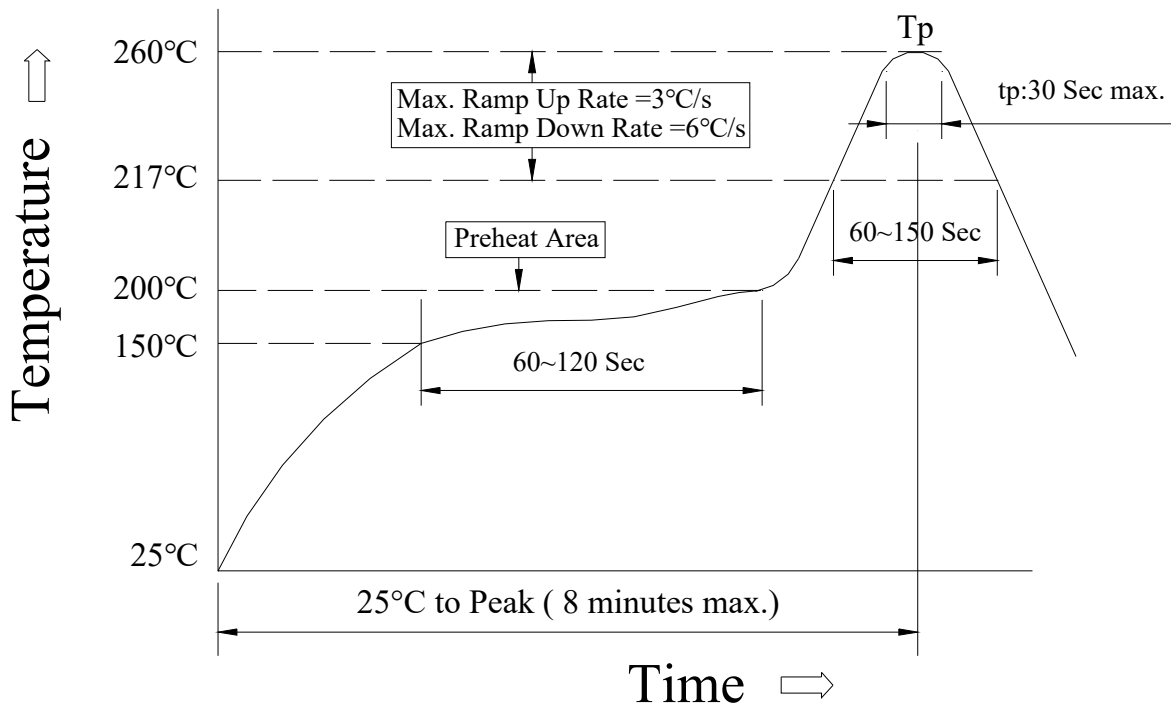

(1) Reflow Soldering Method :

Reflow Soldering	Tp:255~260°C	Max.30 seconds (tp)
	217°C	60~150 seconds
Pre-Heat	150 ~ 200°C	60~120 seconds
Time 25°C to peak temperature	8 minutes max.	

(2) Soldering iron Method : 350 ± 5°C max.3 seconds