



Connectors > Connector Accessories > Connector Backshells > AMPSEAL 16 Connectors Backshell



Connector Backshell Product Type: **Backshell**

Primary Product Material: **PA66**

Body Orientation: **Right Angle**

Number of Positions: **4**

Compatible With Connector Shape: **Rectangular**

[All AMPSEAL 16 Connectors Backshell \(84\)](#)

Features

Product Type Features

Connector Backshell Product Type	Backshell
----------------------------------	-----------

Configuration Features

Number of Positions	4
---------------------	---

Body Features

Cable Exit Angle	90°
Primary Product Color	Black
Primary Product Material	PA66

Housing Features

Body Orientation	Right Angle
Compatible With Connector Shape	Rectangular

Usage Conditions

Operating Temperature (Max)	70 °C, 75 °C, 80 °C, 85 °C, 90 °C, 100 °C, 105 °C, 110 °C, 120 °C, 125 °C[158 °F][167 °F][176 °F][185 °F][194 °F][212 °F][221 °F][230 °F]
-----------------------------	-------------------------------------------------------------------------------------------------------------------------------------------



	°F][248 °F][257 °F]
Operating Temperature Range	-40 – 125 °C[-40 – 257 °F]

Industry Standards

UL Flammability Rating	UL 94V-0
------------------------	----------

Packaging Features

Packaging Method	Bag & Box
------------------	-----------

Other

Serviceable	Yes
-------------	-----

Product Compliance

[For compliance documentation, visit the product page on TE.com>](#)

EU RoHS Directive 2011/65/EU	Compliant
EU ELV Directive 2000/53/EC	Compliant
China RoHS 2 Directive MIIT Order No 32, 2016	No Restricted Materials Above Threshold
EU REACH Regulation (EC) No. 1907/2006	Current ECHA Candidate List: JUNE 2024 (241) Candidate List Declared Against: JUNE 2024 (241) Does not contain REACH SVHC
Halogen Content	Low Halogen - Br, Cl, F, I < 900 ppm per homogenous material. Also BFR/CFR/PVC Free
Solder Process Capability	Not applicable for solder process capability

Product Compliance Disclaimer

This information is provided based on reasonable inquiry of our suppliers and represents our current actual knowledge based on the information they provided. This information is subject to change. The part numbers that TE has identified as EU RoHS compliant have a maximum concentration of 0.1% by weight in homogenous materials for lead, hexavalent chromium, mercury, PBB, PBDE, DBP, BBP, DEHP, DIBP, and 0.01% for cadmium, or qualify for an exemption to these limits as defined in the Annexes of Directive 2011/65/EU (RoHS2). Finished electrical and electronic equipment products will be CE marked as required by Directive 2011/65/EU. Components may not be CE marked. Additionally, the part numbers that TE has identified as EU ELV compliant have a maximum concentration of 0.1% by weight in homogenous materials for lead, hexavalent chromium, and mercury, and 0.01% for cadmium, or qualify for an exemption to these limits as defined in the Annexes of Directive 2000/53/EC (ELV). Regarding the REACH Regulation, the information TE provides on SVHC in articles for this part number is based on the latest European Chemicals Agency (ECHA) 'Guidance on requirements for substances in articles' posted at this URL: <https://echa.europa.eu/guidance-documents/guidance-on-reach>

Compatible Parts



Also in the Series | AMPSEAL 16

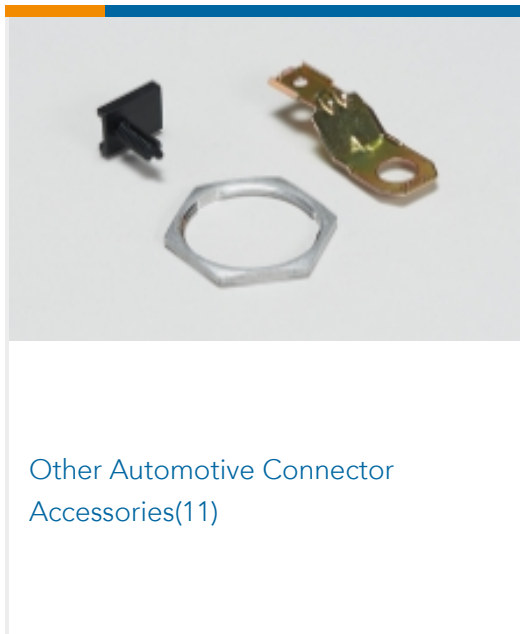
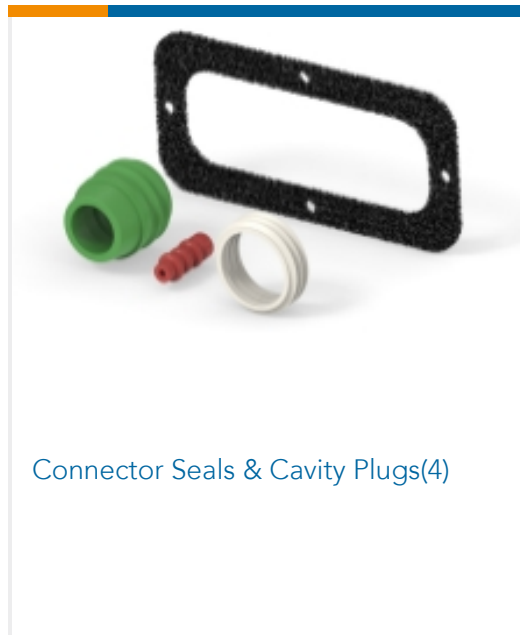
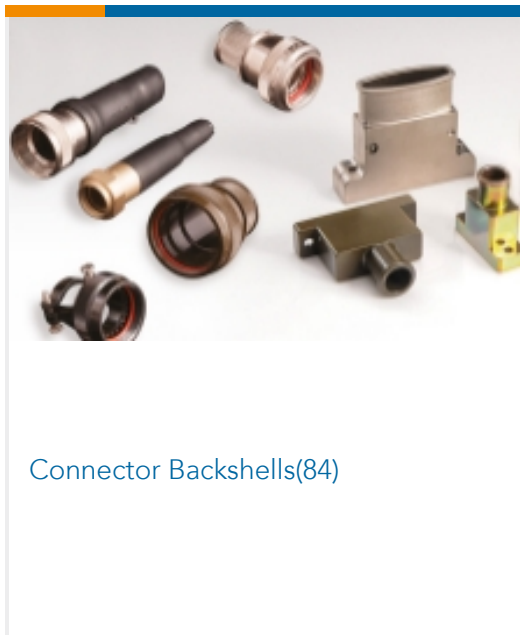
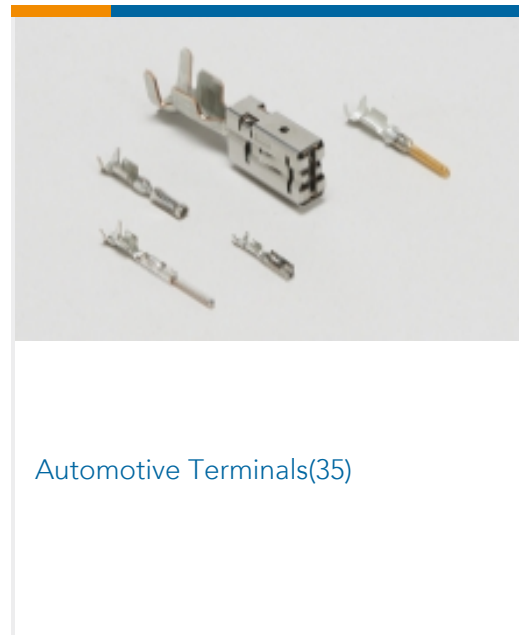
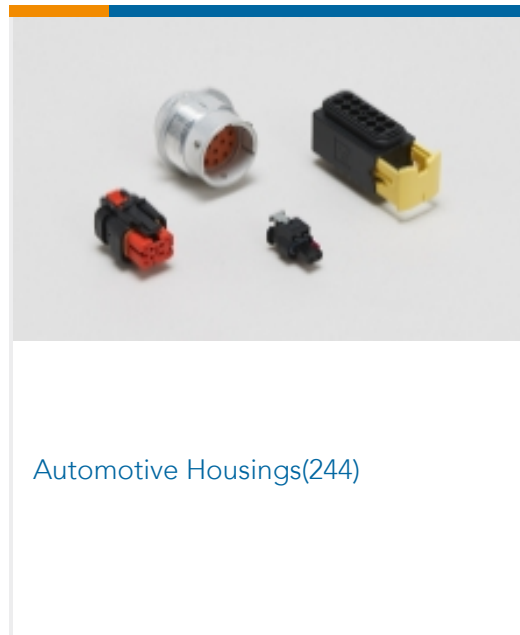
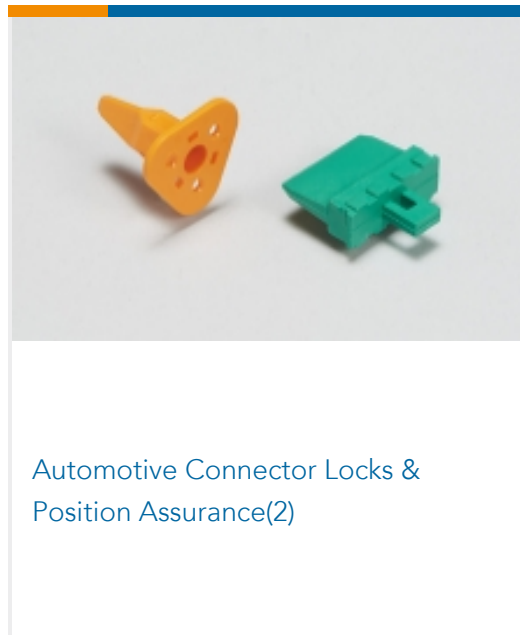
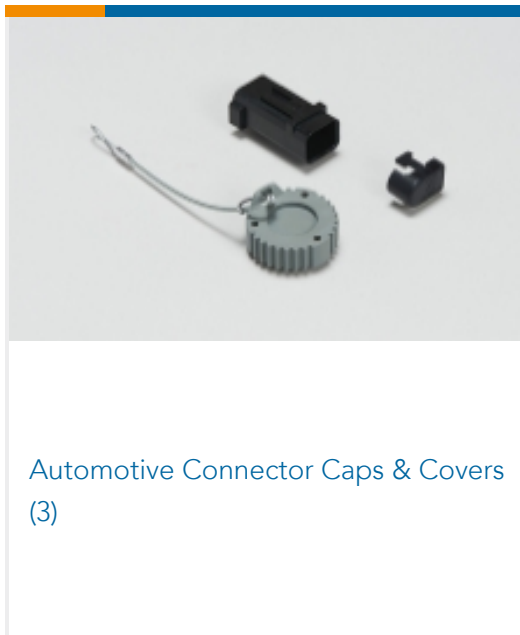

Customers Also Bought



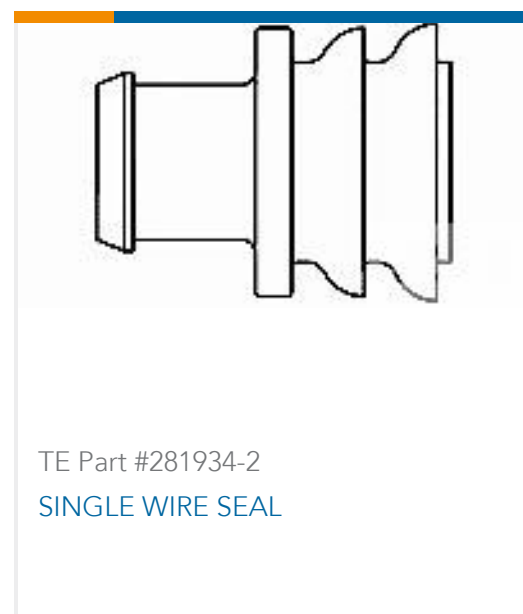

Documents

Product Drawings

[AS16,PLUG BACKSHELL KIT,RA,04P,NC16](#)

English

CAD Files

[3D PDF](#)

3D

Customer View Model

[ENG_CVM_CVM_2302492-2_A.2d_dxf.zip](#)

English

Customer View Model

[ENG_CVM_CVM_2302492-2_A.3d_igs.zip](#)

English

Customer View Model

[ENG_CVM_CVM_2302492-2_A.3d_stp.zip](#)

English

By downloading the CAD file I accept and agree to the [Terms and Conditions](#) of use.

Datasheets & Catalog Pages

[ICT Terminals and Connectors Catalogue](#)

English

Product Specifications

[Application Specification](#)

English

Instruction Sheets

[Instruction Sheet \(U.S.\)](#)

English