

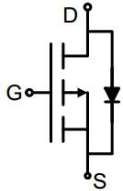
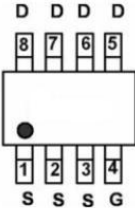

P-Channel Enhancement Mode Power MOSFET

<p>Description</p> <p>The 4435 uses advanced trench technology to provide excellent $R_{DS(ON)}$, low gate charge. It can be used in a wide variety of applications.</p> <p>General Features</p> <ul style="list-style-type: none"> ● V_{DS} -30V ● I_D (at $V_{GS} = -10V$) -11A ● $R_{DS(ON)}$ (at $V_{GS} = -10V$) < 20mΩ ● $R_{DS(ON)}$ (at $V_{GS} = -4.5V$) < 33mΩ ● 100% Avalanche Tested ● RoHS Compliant <p>Application</p> <ul style="list-style-type: none"> ● Power switch ● DC/DC converters 		 <p>Schematic diagram</p>  <p>pin assignment</p>  <p>SOP-8</p>	
Device	Package	Marking	Packaging
4435	SOP-8	4435	4000pcs/Reel

Absolute Maximum Ratings $T_C = 25^\circ C$, unless otherwise noted

Parameter	Symbol	Value	Unit
Drain-Source Voltage	V_{DS}	-30	V
Continuous Drain Current	I_D	-11	A
Pulsed Drain Current (note1)	I_{DM}	-44	A
Gate-Source Voltage	V_{GS}	±20	V
Power Dissipation	P_D	2.5	W
Operating Junction and Storage Temperature Range	T_J, T_{stg}	-55 To 150	°C

Thermal Resistance

Parameter	Symbol	Value	Unit
Thermal Resistance, Junction-to-Ambient	R_{thJA}	50	°C/W

Specifications $T_J = 25^\circ\text{C}$, unless otherwise noted						
Parameter	Symbol	Test Conditions	Value			Unit
			Min.	Typ.	Max.	
Static Parameters						
Drain-Source Breakdown Voltage	$V_{(BR)DSS}$	$V_{GS} = 0V, I_D = -250\mu A$	-30	--	--	V
Zero Gate Voltage Drain Current	I_{DSS}	$V_{DS} = -30V, V_{GS} = 0V$	--	--	-1	μA
Gate-Source Leakage	I_{GSS}	$V_{GS} = \pm 20V$	--	--	± 100	nA
Gate-Source Threshold Voltage	$V_{GS(th)}$	$V_{DS} = V_{GS}, I_D = -250\mu A$	-1	-1.4	-2.5	V
Drain-Source On-Resistance	$R_{DS(on)}$	$V_{GS} = -10V, I_D = -10A$	--	12	20	m Ω
		$V_{GS} = -4.5V, I_D = -5A$	--	18	33	
Forward Transconductance	g_{FS}	$V_{DS} = -5V, I_D = -10A$	--	20	--	S
Dynamic Parameters						
Input Capacitance	C_{iss}	$V_{GS} = 0V,$ $V_{DS} = -15V,$ $f = 1.0\text{MHz}$	--	1818	--	pF
Output Capacitance	C_{oss}		--	233	--	
Reverse Transfer Capacitance	C_{rss}		--	203	--	
Total Gate Charge	Q_g	$V_{DD} = -15V,$ $I_D = -5A,$ $V_{GS} = -10V$	--	40	--	nC
Gate-Source Charge	Q_{gs}		--	5	--	
Gate-Drain Charge	Q_{gd}		--	7.5	--	
Turn-on Delay Time	$t_{d(on)}$	$V_{DD} = -15V,$ $I_D = -5A,$ $R_G = 2.7\Omega$	--	20	--	ns
Turn-on Rise Time	t_r		--	12	--	
Turn-off Delay Time	$t_{d(off)}$		--	55	--	
Turn-off Fall Time	t_f		--	15	--	
Drain-Source Body Diode Characteristics						
Continuous Body Diode Current	I_S	$T_C = 25^\circ\text{C}$	--	--	-11	A
Body Diode Voltage	V_{SD}	$T_J = 25^\circ\text{C}, I_{SD} = -10A, V_{GS} = 0V$	--	--	-1.2	V
Reverse Recovery Charge	Q_{rr}	$I_F = -11A, V_{GS} = 0V$ $di/dt = -100A/\mu s$	--	15	--	nC
Reverse Recovery Time	T_{rr}		--	10	--	ns

Notes

1. Repetitive Rating: Pulse width limited by maximum junction temperature
2. Identical low side and high side switch with identical R_G

Gate Charge Test Circuit

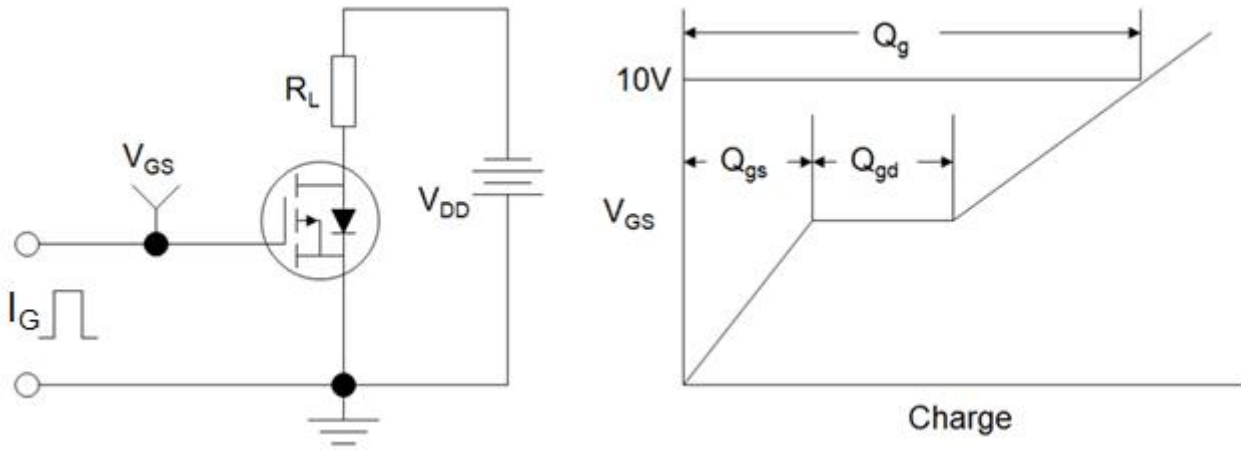

Switch Time Test Circuit



EAS Test Circuit

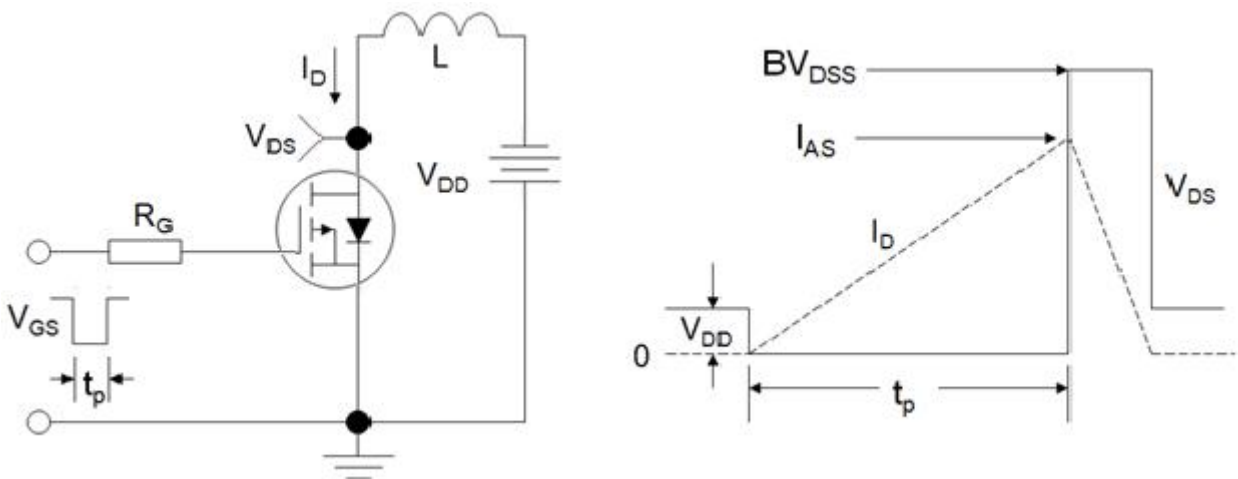

Typical Characteristics $T_J = 25^\circ\text{C}$, unless otherwise noted

Figure 1. Output Characteristics

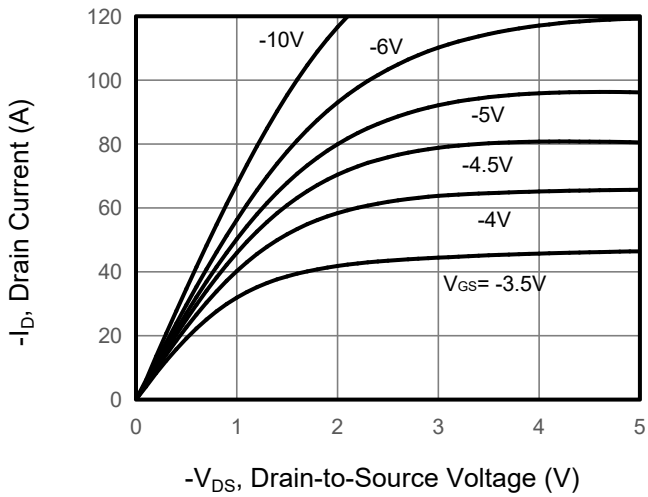

Figure 2. Transfer Characteristics

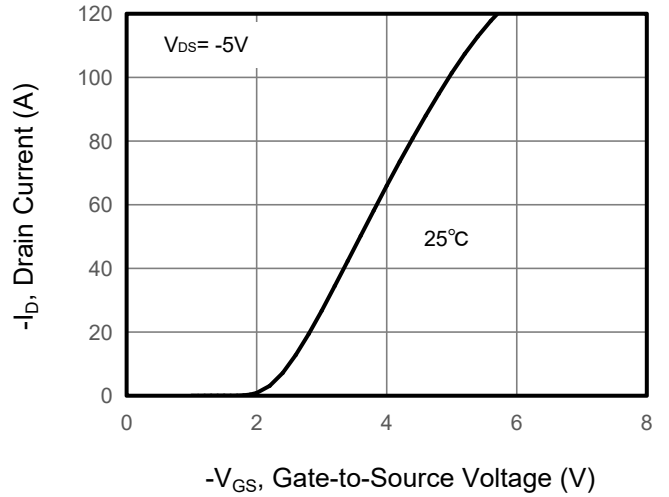

Figure 3. Drain Source On Resistance

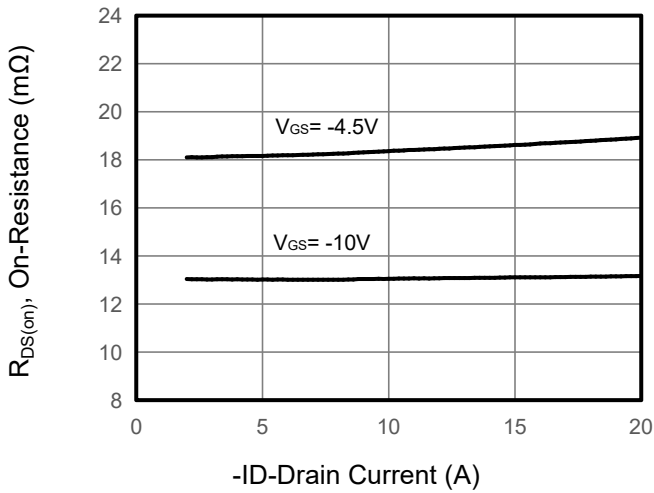

Figure 4. Gate Charge

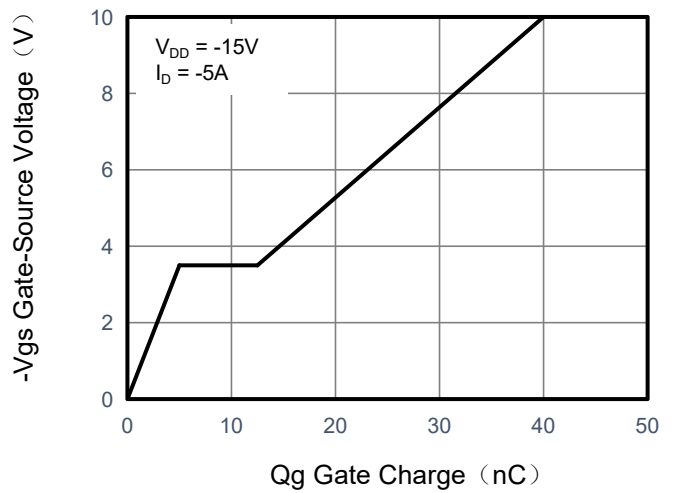

Figure 5. Capacitance

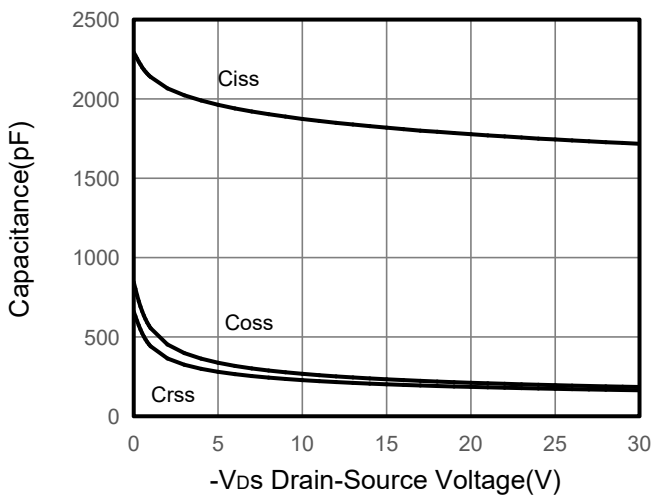
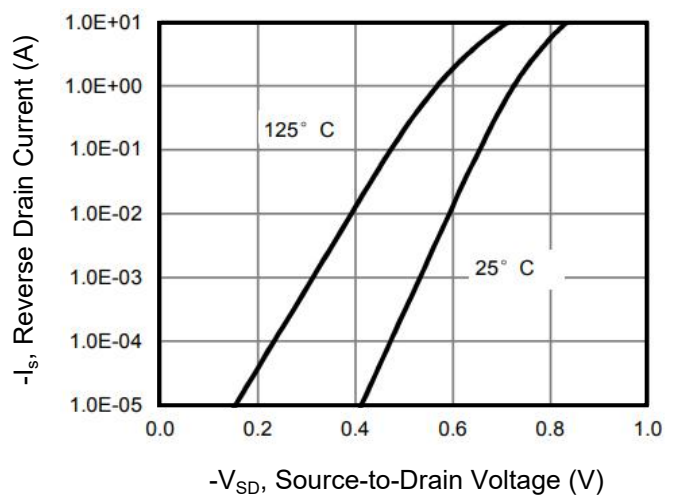

Figure 6. Source-Drain Diode Forward



Typical Characteristics $T_J = 25^\circ\text{C}$, unless otherwise noted

Figure 7. Drain-Source On-Resistance

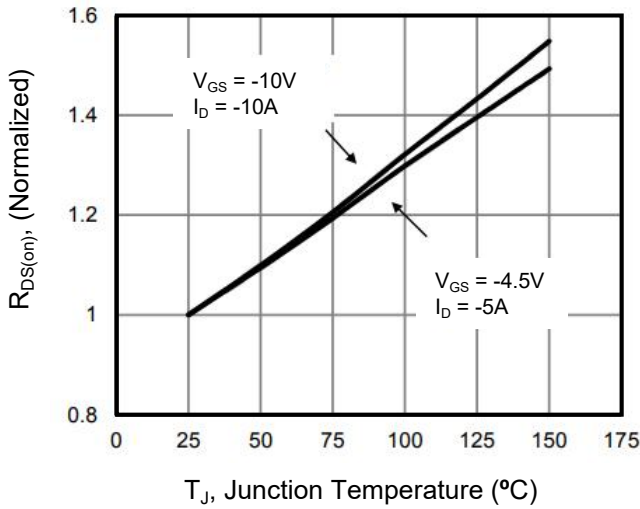

Figure 10. Safe Operation Area

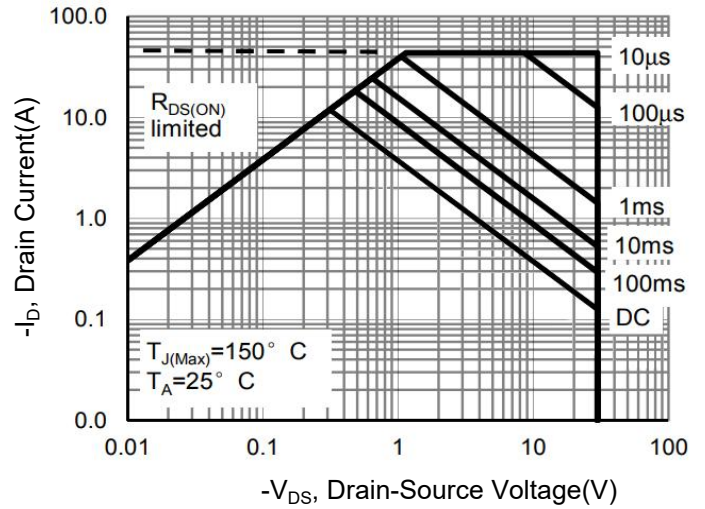
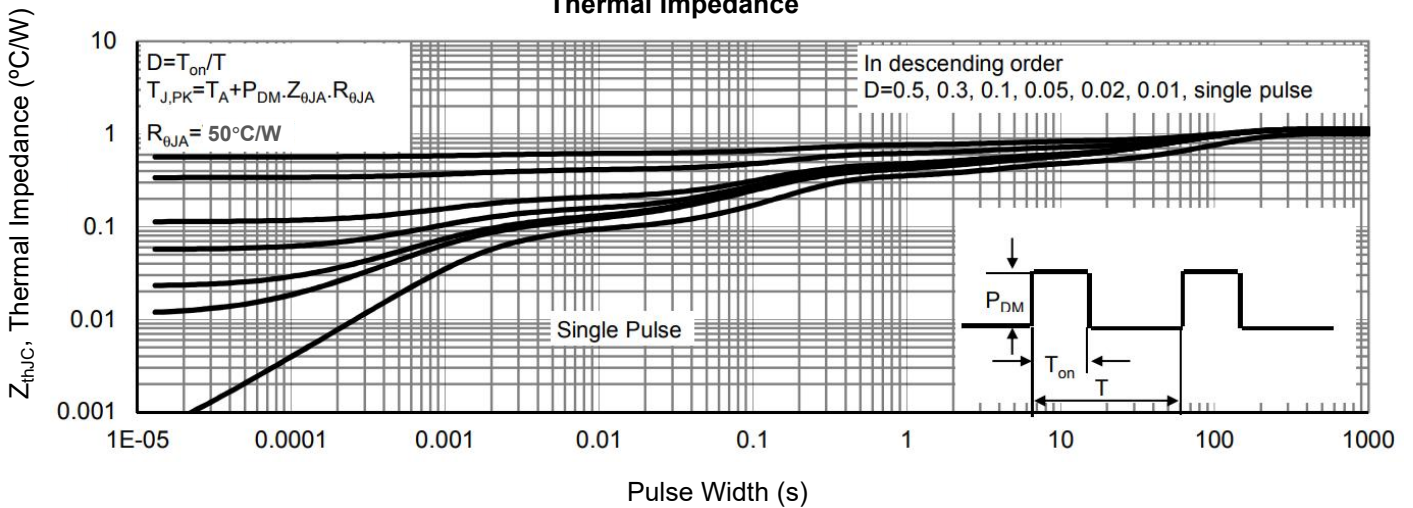
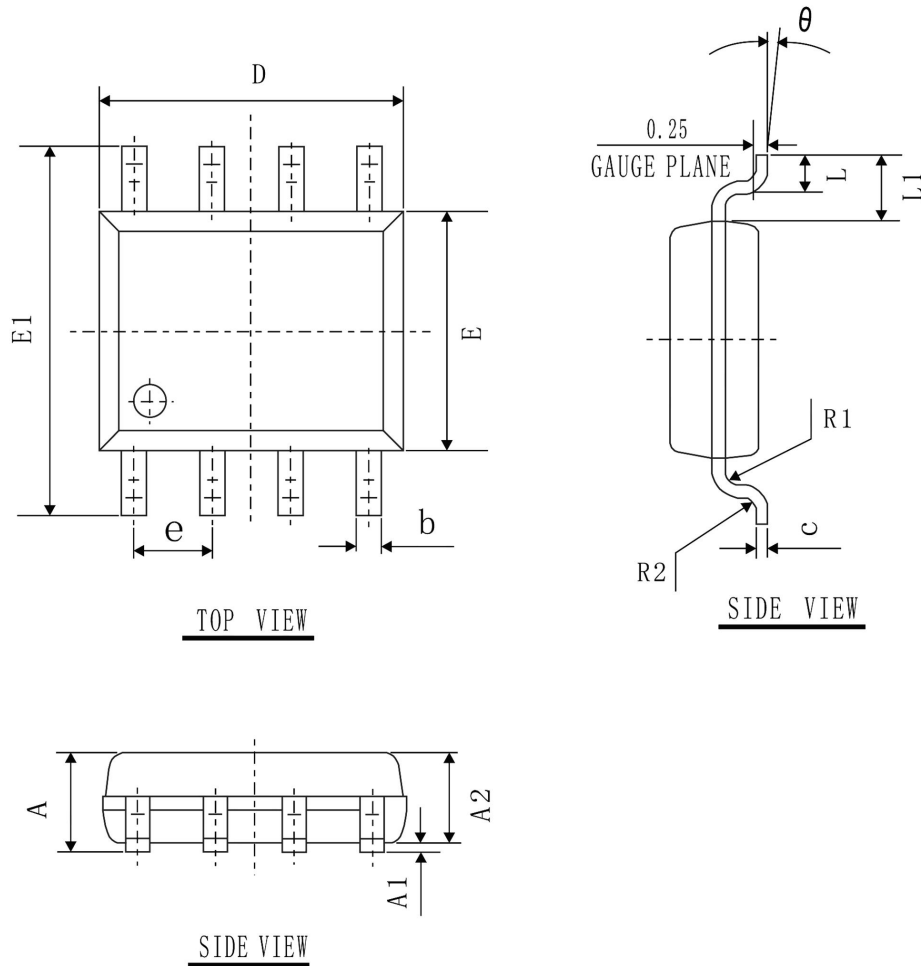

Figure 9. Normalized Maximum Transient Thermal Impedance



SOP-8 Package Information



COMMON DIMENSIONS
(UNITS OF MEASURE=mm)

SYMBOL	MIN	NOM	MAX
A	1.40	1.60	1.80
A1	0.05	0.15	0.25
A2	1.35	1.45	1.55
b	0.30	0.40	0.50
c	0.153	0.203	0.253
D	4.80	4.90	5.00
E	3.80	3.90	4.00
E1	5.80	6.00	6.20
L	0.45	0.70	1.00
θ	2°	4°	6°
L 1	1.04 REF		
e	1.27 BSC		
R1	0.07 TYP		
R2	0.07 TYP		