

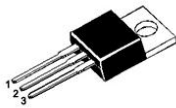

## LOW VF SCHOTTKY RECTIFIER

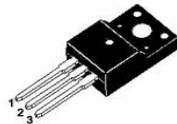

TO-220AB/CT



TO-220F/FCT

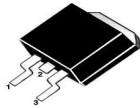

TO-263/DC

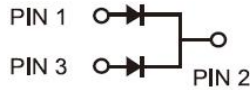

### FEATURES

- Low forward voltage
- High current capability
- High forward surge capability
- Low power losses, High efficiency
- Guarding for over voltage protection



**RoHS**  
COMPLIANT

### APPLICATIONS

Low VF Schottky barrier rectifier are designed for high frequency, miniature switched mode power supplies such as adapters ,lighting and on-board DC/DC conerters

### Primary Characteristic

$I_o$	2*15A
$V_{RRM}$	60V
$I_{FSM}$	250A
$V_F$	0.47V
$T_{jmax}$	150°C

### MECHANICAL DATA

- **Case:** Molded plastic
- **Polarity:** As marked
- **Mounting Position:** Any
- **Molded Plastic:** UL Flammability Classification Rating 94V-0
- Lead free in compliance with EU RoHS 2011/65/EU directive
- Solder bath temperature 275°C maximum,10s per JESD 22-B106

### Maximum Ratings (Per Leg) at Ta=25°C unless otherwise specified

Characteristics	Symbol	Value	Unit
Maximum Repetitive Peak Reverse Voltage	$V_{RRM}$	60	V
Working Peak Reverse Voltage	$V_{RWM}$	60	V
Maximum DC Blocking Voltage	$V_{DC}$	60	V
Maximum Average Forward Rectified Current	$I_o$	Per Leg	15
		Total	30
Peak Forward Surge Current,8.3 ms Single Half Sine-wave Superimposed on Rated Load (JEDEC method)	$I_{FSM}$	250	A
Operating Temperature Range	$T_J$	-50 to +150	°C
Storage Temperature Range	$T_{STG}$	-50 to +150	°C
Typical Thermal Resistance (Note1) TO-220AB,TO-263 TO-220F	$R_{\theta JC}$	2	°C/W
		4	

Note1: Thermal resistance from Junction to case per leg mounted on heatsink.

### Electrical Characteristics (Per Leg) unless otherwise specified

Characteristics	Symbol	Value		Unit	
Forward Voltage Drop(Note2)	$V_F$	Typ.	Max.	V	
		at $I_F=5A$	TA=25°C		0.40
		TA=125°C	0.31		-
at $I_F=10A$		TA=25°C	0.46		0.53
		TA=125°C	0.39		-
at $I_F=15A$		TA=25°C	0.52		0.60
		TA=125°C	0.47		-
Maximum Reverse Current at $V_R=60V$	$I_R$	TA=25°C	25		150
		TA=125°C	17	-	
				µA	
				mA	

Note2:Pulse test: 300 µs pulse width, 1 % duty cycle



## RATINGS AND CHARACTERISTIC CURVES

FIG. 1 MAXIMUM FORWARD CURRENT DERATING CURVE

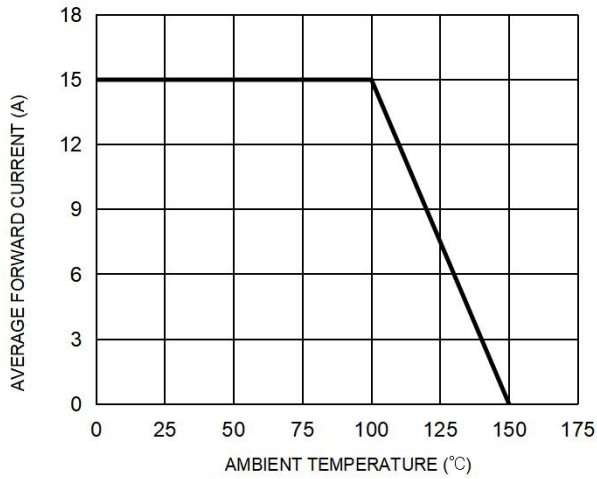

FIG. 2 MAXIMUM NON-REPETITIVE FORWARD SURGE CURRENT PER LEG

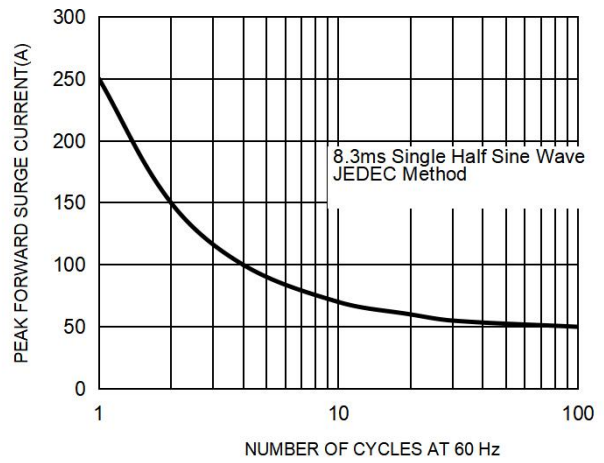

FIG. 3 TYPICAL FORWARD CHARACTERISTICS PER LEG

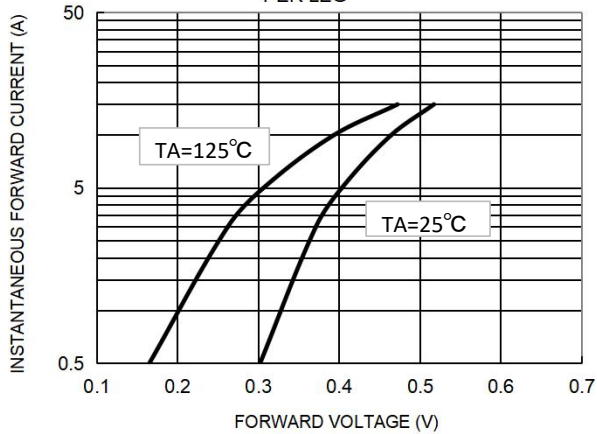
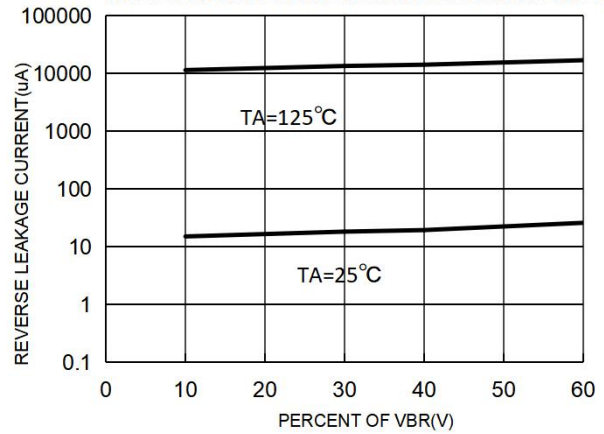

FIG. 4 TYPICAL REVERSE CHARACTERISTICS PER LEG





## Package Outline Dimensions millimeters

TO-220AB

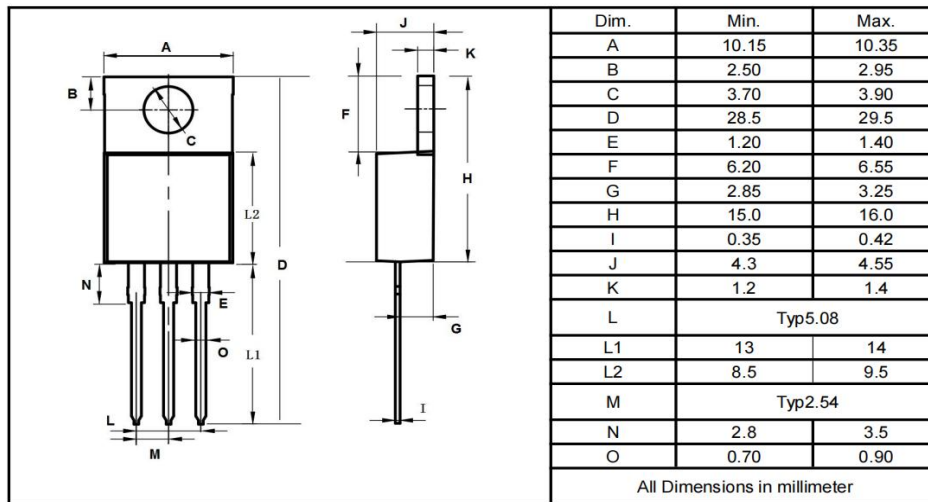

TO-220F

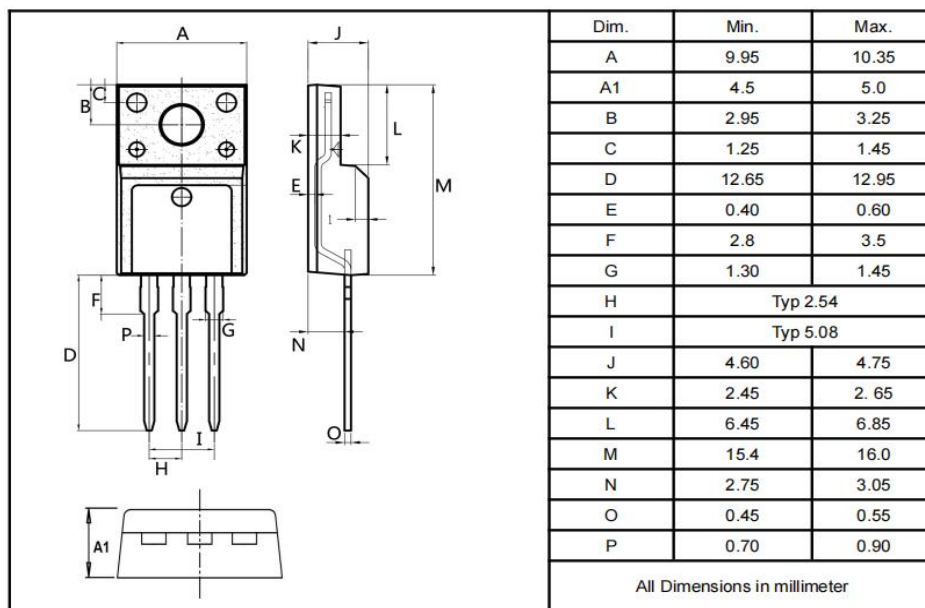

TO-263

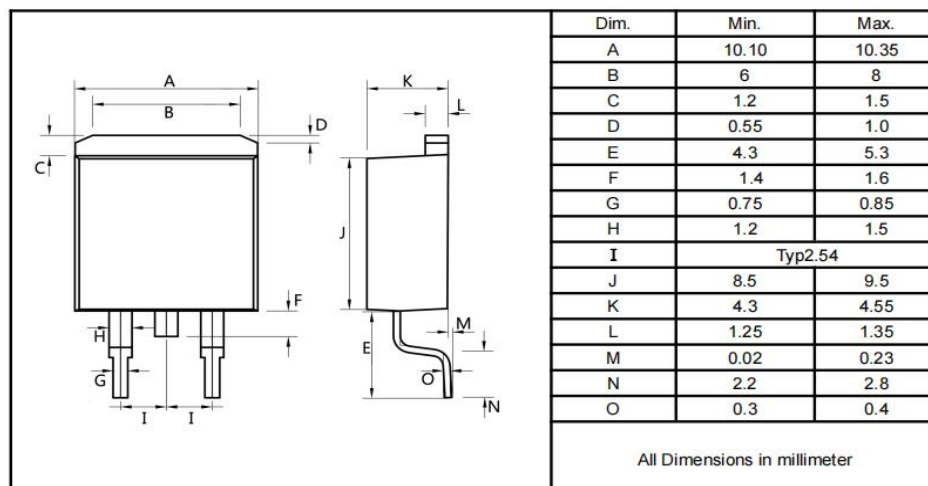



# SBT30L60CT/FCT/DC

## Marking on the body

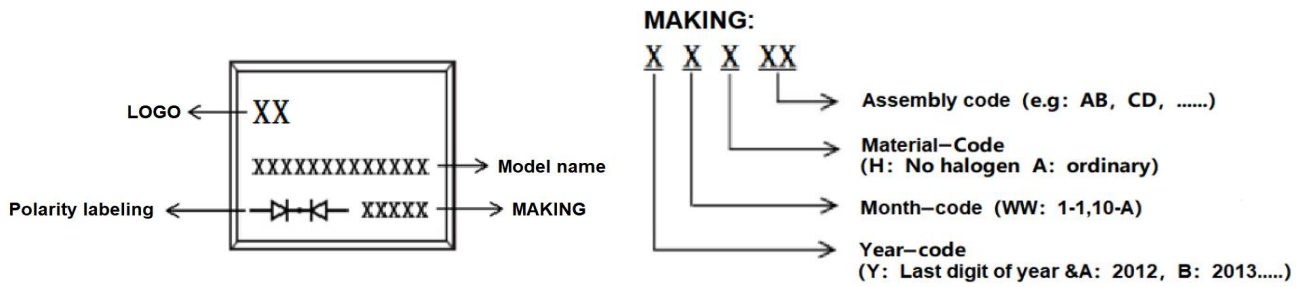

## Ordering information

Part Number	Package	Unit Weight	Base Quantity	Delivery mode
SBT30L60CT	TO-220AB	0.07oz(1.96g)	50 pcs / tube	1000pcs/box 5000pcs/carton
SBT30L60FCT	TO-220F	0.06oz(1.74g)	50 pcs / tube	1000pcs/box 5000pcs/carton
SBT30L60DC	TO-263	0.04oz(1.16g)	50 pcs / tube	1000pcs/box 5000pcs/carton
SBT30L60DC-R	TO-263	0.04oz(1.16g)	800 pcs / reel	1600pcs/box 8000pcs/carton

Note: For Halogen Free molding compound, add "H" suffix to part number above.

## packing instruction

PKG	最小包装	内盒	外箱
TO-220AB TO-220F TO-263			
	50pcs/管	1000pcs/盒	5000pcs/箱
TO-263-R			
	800pcs/盘	1600pcs/盒	8000pcs/箱

## Notice

1. All product, product specifications and data are subject to change without notice to improve. The right to explain is owned by LINGXUN electronics company.

2. Confirm that operation temperature is within the specified range described in the product specification. Avoid applying power exceeding normal rated power;

exceeding the power rating under steady-state loading condition may negatively affect product performance and reliability.

3. LINGXUN electronics shall not be in any way responsible or liable for failure induced under deviant condition from what is defined in this document.