



PSC-151 Series



Features:

- Universal AC input (88-264V AC)
- Installed on DIN rail TS-35 / 7.5 or 15
- Built-in active PFC function, PF > 0.95
- 150% peak load capability
- 100% full load burn-in test
- Protection: SCP, OLP, OVP, OTP
- Two selectable peak load modes
- Built-in DC OK Relay contact
- Built-in Remote ON / OFF function
- 3 years warranty
- UL 508

OUTPUT

Cat. No.	PSC-15124	PSC-15148
----------	-----------	-----------

DC VOLTAGE	24V	48V
RATED CURRENT	6.3A	3.2A
CURRENT RANGE	0~6.3A	0~3.2A
RATED POWER	150W	150W
PEAK CURRENT	9.45A	4.8A
PEAK POWER	225W (3sec.) 3 seconds or 20% duty cycle max. and the average output power should not exceed the rate power.	
RIPPLE & NOISE (max)	240mVp-p Ripple & noise are measured at 20MHz of bandwidth by using a 12" twisted pair-wire terminated with a 0.1µF & 47µF parallel capacitor.	480mVp-p
VOLTAGE ADJ. RANGE	-2% ~ +8%	-2% ~ +8%
VOLTAGE TOLERANCE	±1.0% Tolerance: includes set up tolerance, line regulation and load regulation.	±1.0%
LINE REGULATION	±0.5%	±0.5%
LOAD REGULATION	±1.0%	±1.0%
SETUP, RISE TIME	700ms, 30ms / 230VAC / 115VAC at full load	
HOLD UP TIME (Typ.)	16ms / 230VAC; 16ms / 115VAC at full load	

INPUT

VOLTAGE RANGE	88 ~ 264VAC; 124 ~ 373VDC Derating may apply in low input voltage. Please check the derating curve for more details.	
FREQUENCY RANGE	47 ~ 63Hz	
POWER FACTOR(Typ.)	0.9 / 230VAC; 0.98 / 115VAC at full load	
EFFICIENCY (Typ.)	87%	87%
AC CURRENT (Typ.)	2.6A / 115VAC; 1.3A / 230VAC	
INRUSH CURRENT (Typ.)	33A / 115VAC; 65A / 230VAC	
LEAKAGE CURRENT	<1mA/ 240VAC	

PROTECTION

OVERLOAD	Normally works within 105% ~ 150% rated output power for more than 3sec and then shutdown O/P voltage with outo-recovery, > 150% rated power or short circuit is constant current limiting, if o/p drop to 40% rating output voltage then shutdown and auto-recover 5 time, if fault condition not remove in this 5 time, the system well be shutdown and re-power on to recover.	
OVER VOLTAGE	29 ~ 33V Protection type: Latch-off mode, repower on to recover.	56 ~ 65V
OVER TEMPERATURE	95 ±5°C (TSW: detect on heatsink of power diode) Protection type: Shut down o/p voltage, recovers automatically after temperature goes down	

ENVIRONMENT

WORKING TEMP.	-10 ~ +70°C (Refer to derating curve) Installation clearance: 40mm from top, 20mm from bottom, 5mm from the left and right side are recommended when loaded permanently with full power. In case the adjacent device is a heat source, 15mm clearance is recommended.	
WORKING HUMIDITY	20 ~ 95% RH non-condensing	
STORAGE TEMP. / HUMIDITY	-40 ~ +85°C, 10 ~ 95% RH	
TEMP. COEFFICIENT	±0.03% / °C (0 ~ 50°C)	
VIBRATION	10 ~ 500Hz, 2G 10min. / 1cycle, 60min. each along X, Y, Z axes	

SAFETY & EMC

SAFETY STANDARDS	UL 508 / TUV EN 60950-1	
WITHSTAND VOLTAGE	I/P-O/P: 4242VDC, I/P-FG: 2121VDC, O/P-FG: 707VDC, O/P-DC OK: 707VDC	
ISOLATION RESISTANCE	I/P-O/P, I/P-FG, O/P-FG: >100M Ohms / 500VDC / 25°C / 70% RH	
EMI CONDUCTION & RADIATION	EN55022 (CISPR22) Class B	
HARMONIC CURRENT	EN61000-3-2, -3	
EMS IMMUNITY	Compliance to EN61000-4-2,3,4,5,6,8,11; ENV50204; EN55024; EN61000-6-2; (EN50082-2); EN61204-3; heavy industry level; criteria A, MEET SEMI F47 The power supply is considered a component which will installed into a final equipment. The final equipment must be re-confirmed that is still meets EMC directives.	

OTHERS

DC OK RELAY. CONTACT RATINGS (max)	60VDC / 0.3A, 30VDC / 1A, 30VAC / 0.5A resistive load
MTBF	62.7K HRS (MIL-HDBK-217F)
DIMENSION	55.5x125.2x99.8 mm (WxHxD)
PACKING	0.9kg; 12pcs / 12.8kg
COOLING	Free air convection

All parameters NOT specially mentioned are measured at 230VAC input, rated load and 25°C of ambient temperature.

For the latest on Altech Power Supplies please visit www.altechcorp.com/power.



Mechanical Drawings

Unit : mm / inch

Terminal Pin No. Assignment (TB1)

Pin NO.	Assignment
1	FG Ⓢ
2	AC/L
3	AC/N

Terminal Pin No. Assignment (TB2)

Pin NO.	Assignment
1	DC+
2	DC-
3	INH+
4	INH-
5,6	Relay Contact

Switch No. Assignment

SW NO.	Assignment
SW1	PEAK LOAD SETTING
SW2	REMOTE ON/OFF SETTING

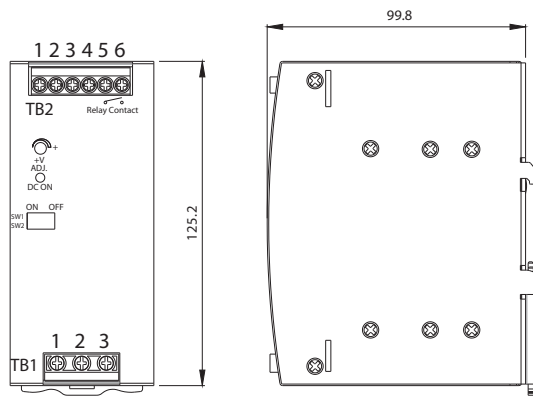
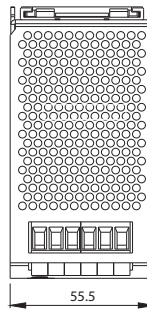

Block Diagram

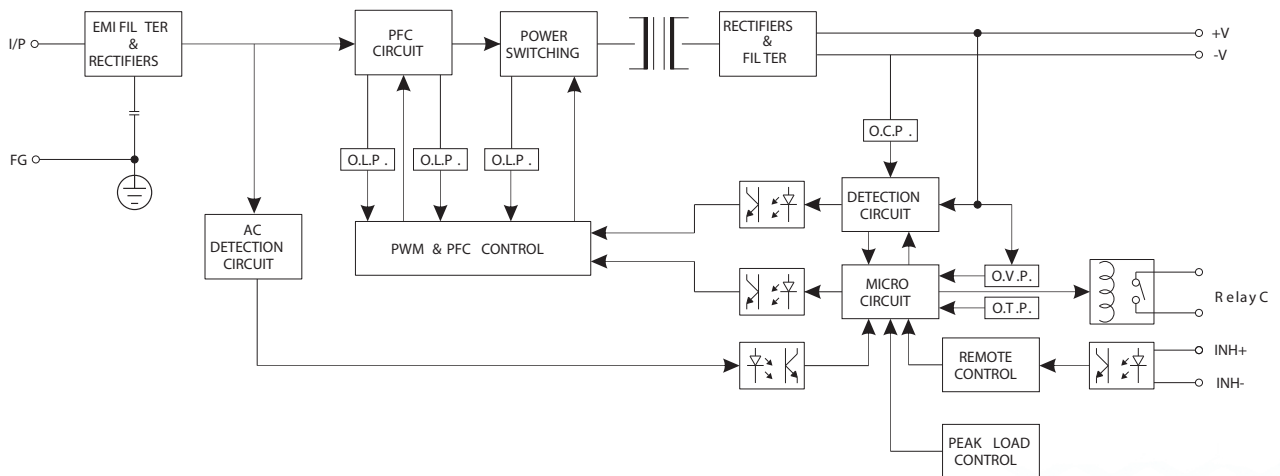

DC OK Relay Contact

Contact Close	When the output voltage reaches the adjusted output voltage.
Contact Open	When the output voltage drop below 45% rated output voltage.
Contact Ratings(max.)	30V/1A resistive load



PSC-151 Series



Peak Load SW1 ON (Mode1) Default setting

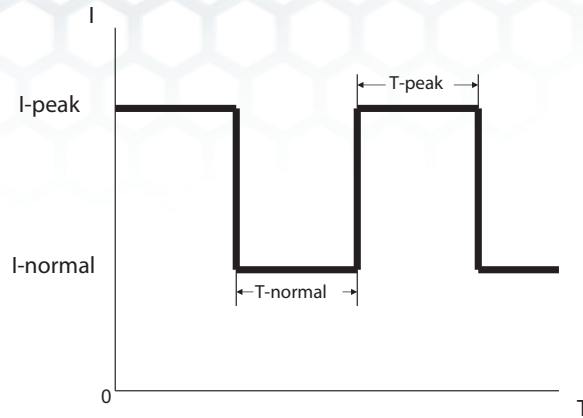

T-peak presents while the unit is working within 110%~150% Rating output power. See curve " B " for the variation in T-peak between output current and holdup time. If T-peak is more than the time setting in curve "B", the output current will drop to the constant current limit (I-normal) that is 105% rating power, meanwhile, I- normal and T-normal will be presenting. See curve "A" for the timing back to I-Peak of T-normal and this Mode can use for easy 2-stage battery charger.

Peak Load SW2 OFF (Mode2)

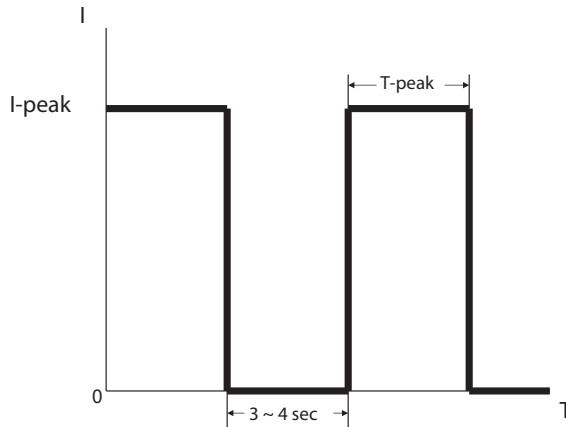

T-peak presents while the unit is working within 110%~150% Rating output power. See curve " B " for the variation in T-peak between output current and holdup time. If T-peak is more than the time setting in curve "B", the output current will be shut down for 3~4 sec, then auto-recovery.

T-normal (Sec.)

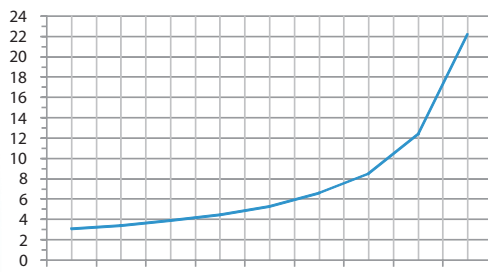

10% 20% 30% 40% 50% 60% 70% 80% 90% I-normal
Load (%)
CURVE A

T-peak (Sec.)

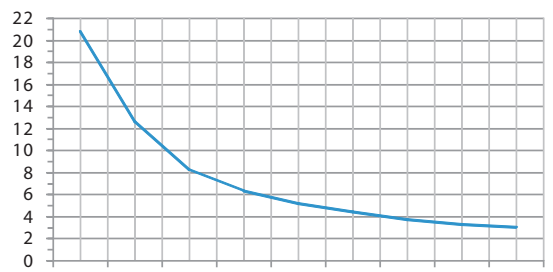

110% 115% 120% 125% 130% 135% 140% 145% 150% I-peak
Load (%)
CURVE B

PSC-151 Series



Slimline single phase

Low Profile single phase

Industrial Metal Case single phase

Industrial Metal Case three phase

High Efficiency compact housing

Accessories

Remote ON/OFF

The PSU can be turned ON/OFF by using the "Remote Control" function.

SW2	INH+(3 PIN)/ INH-(4 PIN)	Output Status
OFF	SW ON (>2.5V)	ENABLE
OFF	SW OFF (<0.8V)	DISABLE
ON	SW ON (>2.5V)	DISABLE
ON	SW OFF (<0.8V)	ENABLE

(De fault Setting)

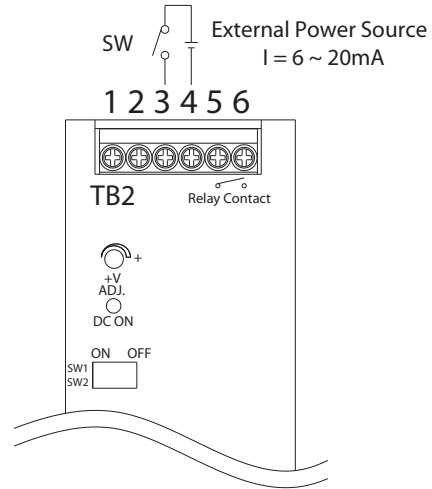

Derating Curve

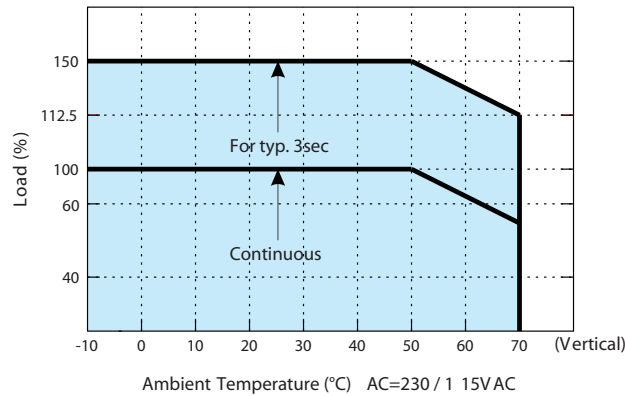

Output derating VS input coltage

