



D-FRAME SOLENOID

Two position linear solenoid with D-frame construction.

Features

- Balance of cost and performance
- AC solenoids and DC solenoids available
- Encapsulated coils on most models
- UL approval on many models



Electrical Specifications	
Coil Voltages	6, 12, 24, 120, 240 VAC 6, 12, 24, 110 VDC
Coil Power	21 VA Continuous, 120 VA Intermittent, 210 VA Pulse, 11 Watts Continuous, 27 Watts Intermittent, 110 Watts Pulse
Coil Termination	.187" Quick Connect Terminals (standard) .250" Quick Connect Terminals (optional) Wire leads optional with tape wrapped coil
Duty Cycle	Continuous, intermittent and pulse duty available (see standard part numbers on page 4)
Coil Treatment	Encapsulated (tape wrap optional)
Insulation Class	Class A Rating - 105°C (221°F) Max. (standard) Class F Rating - 155°C (311°F) Max. (optional)
Dielectric Strength	30 Volts and Under: 500 VRMS Over 30 Volts: 1000 VRMS plus 2X rated voltage for 1 minute
Mechanical Specifications	
Size	1.737" (L) x 1.437" (W) x 1.626" (H) (See dimensional drawing on page 2)
Forces	See page 3 for force curves
Plunger Diameter	0.500"
Plunger Guide Material	Plastic
Mounting	8X #8-32 UNC-2B Mounting Holes
Weight	Plunger - 1.76 oz., Total - 11 oz.
Life Expectancy	250,000 Cycles (Dependent on load conditions)
Agency Approval	
	UL File No. E57982 For Continuous Duty UL File No. E74443 For Insulation Systems S105, S130, S130D, S130D1, S155D

All dimensions in Inches

D-3HD

Dimensional View

Units: Inches [mm]

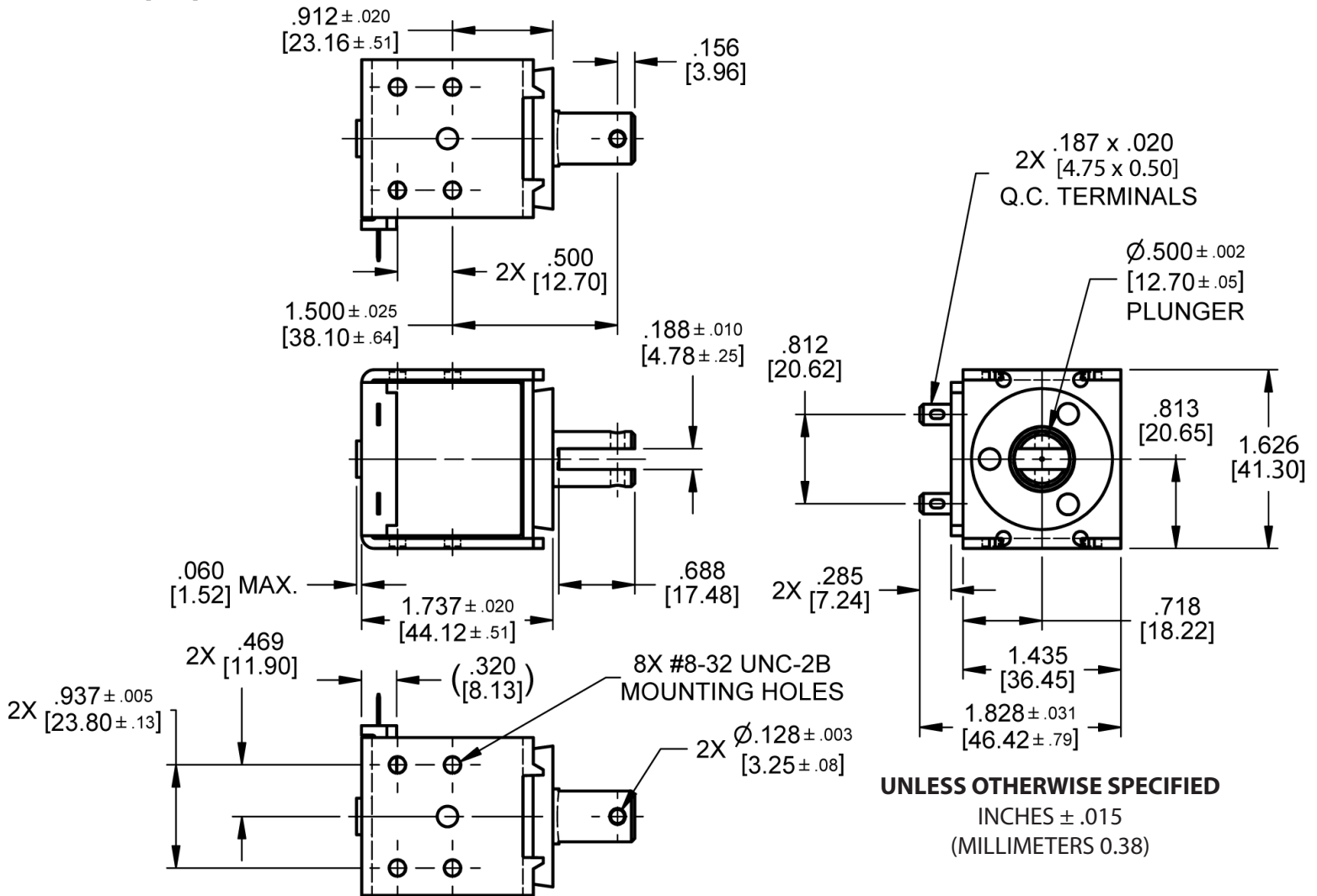

Force Curves

AC Continuous Duty - 21 VA

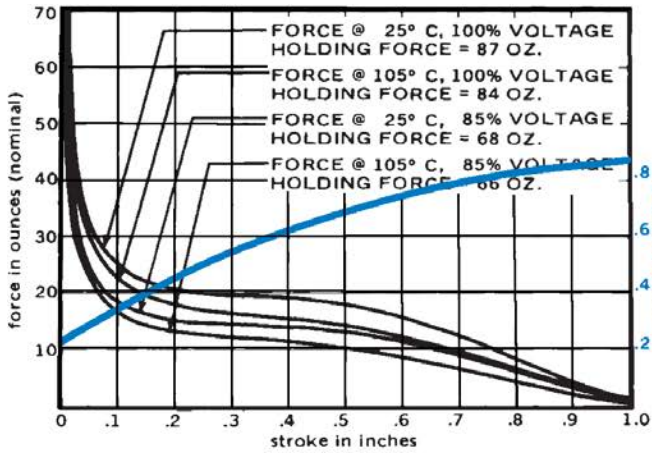

DC Continuous Duty - 11 Watts

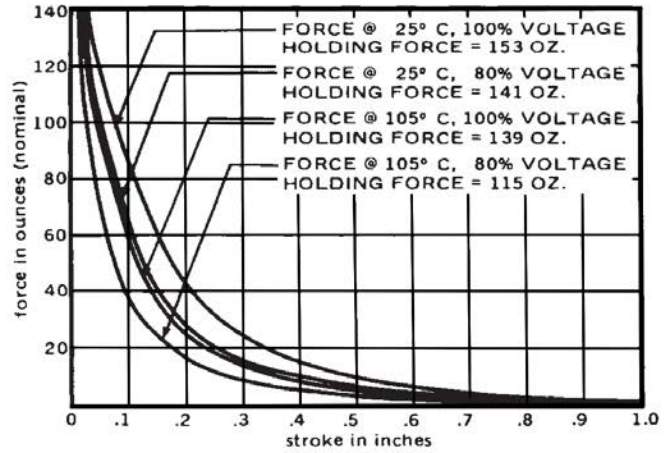

AC Intermittent Duty - 120 VA

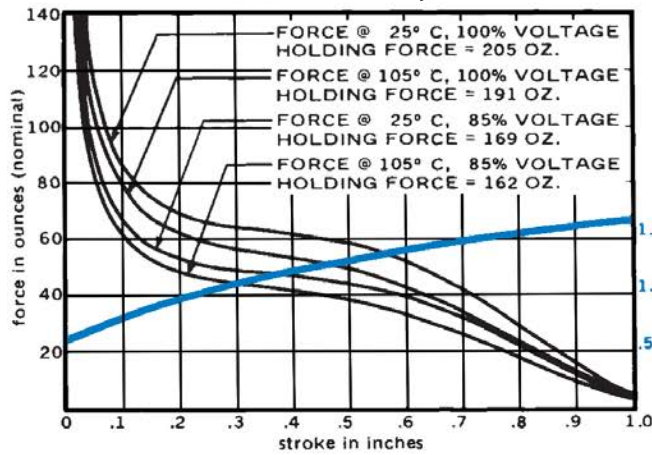

DC Intermittent Duty - 27 Watts

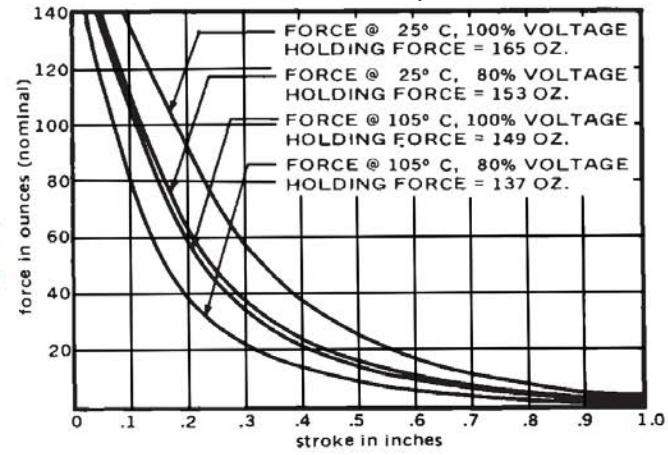

AC Pulse Duty - 210 VA

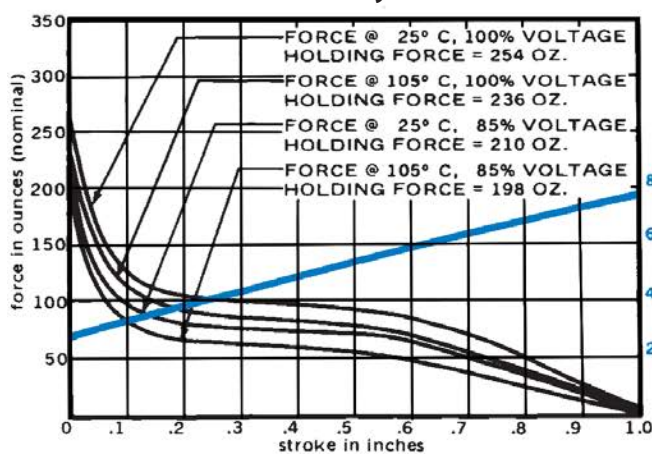

DC Pulse Duty - 110 Watts

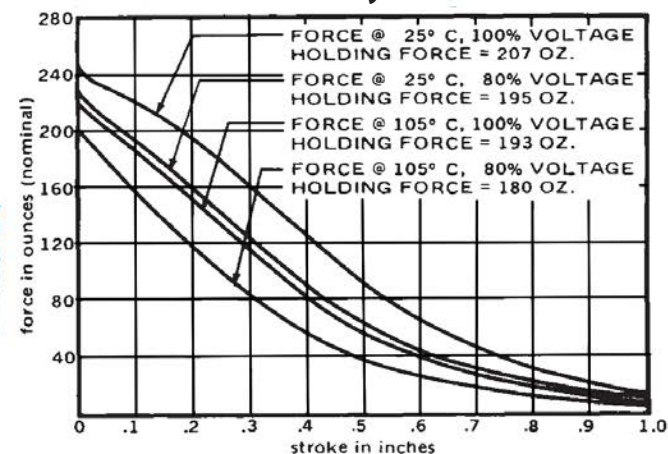

Standard intermittent duty cycle at nominal voltage is 25%, with three (3) minutes maximum "ON" and nine (9) minutes minimum "OFF" in a repetitive cycle. Standard Pulse duty cycle is 10% with 100 milliseconds "ON" and 900 milliseconds "OFF".
NOTE: Approx 36 sq. in. Heat Sink Required

Standard Part Numbers

Parts No.	Voltage	Duty Cycle	Power	Resistance (Ohms)	Operation	Typical Force (oz). 100% Voltage, 77° F, Stroke @				
						0.000"	0.125"	0.250"	0.500"	0.750"
53733-80	6 VAC	Continuous	21 VA	0.26	Pull	87	23	20	18	10
53733-81	12 VAC			1.05						
53733-82	24 VAC			4.21						
53733-84*	120 VAC			109						
53733-85	240 VAC			446						
53733-87	12 VAC	Intermittent	120 VA	0.26	Pull	205	79	65	58	34
53733-88	24 VAC			1.05						
53733-90*	120 VAC			27.6						
53733-91	240 VAC			109						
53733-94	24 VAC	Pulse	210 VA	0.70	Pull	254	115	100	90	63
53733-96	120 VAC			18.0						
53733-97	240 VAC			73.8						
53732-80	6 VDC	Continuous	11 Watts	3.13	Pull	153	74	30	10	4
53732-81*	12 VDC			12.8						
53732-82*	24 VDC			51.5						
53732-84	110 VDC			1100						
53732-86	6 VDC	Intermittent	27 Watts	1.31	Pull	165	134	70	26	10
53732-87*	12 VDC			5.27						
53732-88*	24 VDC			21.4						
53732-90	110 VDC			463						
53732-92	6 VDC	Pulse	110 Watts	.323	Pull	207	215	180	90	40
53732-93	12 VDC			1.31						
53732-94	24 VDC			5.27						
53732-96	110 VDC			109						

(*) Normally Stocked

Non stocked items require a minimum order