

## General Description

The WL2803E is a high-performance, 500mA LDO regulator, offering extremely high PSRR and ultra-low dropout. Ideal for portable RF and wireless applications with demanding performance and space requirements.

The WL2803E is available in 5pin SOT23-5 Package .the output standards of 1.2V 1.5V 1.8V 2.5V 2.8V 3.0V 3.3V

## Features

- Quiescent Current: 60uA
- PSRR:75dB@1KHz
- < 1uA current at shutdown mode
- Output voltage accuracy: tolerance  $\pm 2\%$
- Output current:500mA(Typ.)
- SOT23-5 package

## Applications

- CDM/GSM mobile phone
- PDAs /MP3
- Audio/Video equipment

## Ordering Information

**WL2803E12**

Output voltage: 12=1.2V  
18=1.8V  
30=3.0V  
33=3.3V  
XX=X.XV

## BLOCK DIAGRAM

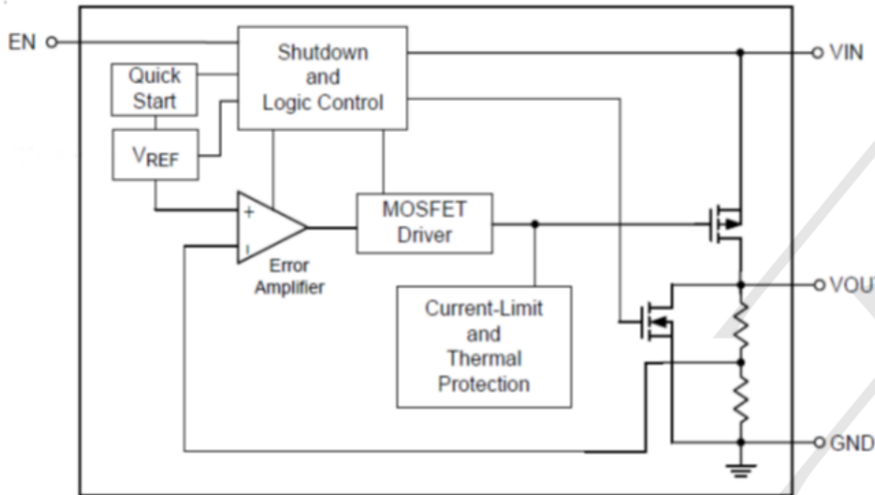

## PIN CONFIGURATION

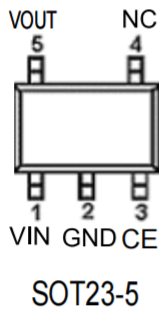

Pin Name	Function
VIN	Supply power
GND	Ground
CE	Enable pin
NC	NC
VOUT	Voltage output

## Absolute Maximum Rating (T<sub>A</sub>=25°C unless otherwise noted)

Parameter	Symbol	Maximum Rating		Unit
Input Voltage	V <sub>IN</sub>	7		V
Output Voltage	V <sub>OUT</sub>	V <sub>SS</sub> -0.3~V <sub>IN</sub> +0.3		
Output Current	I <sub>out</sub>	600		mA
Power Dissipation	P <sub>D</sub>	SOT-23-5	250	mW
Operating Ambient Temperature	T <sub>opr</sub>	-40~+85		
Storage Temperature	T <sub>stg</sub>	-40~+125		

**Electrical Characteristics** (T =25°C unless otherwise noted)

(Vin=Vout+1V,Cin=Cout=1uF,Ta=25°C)

PARAMETER	SYMBOL	CONDITIONS	MIN	TYP	MAX	UNITS
Output Voltage	V <sub>OUT(E)</sub> (Note 2)	I <sub>OUT</sub> =40mA, V <sub>IN</sub> =Vout+1V	X 0.98	V <sub>OUT(T)</sub> (Note 1)	X 1.02	V
Input Voltage	V <sub>IN</sub>				7.0	V
Max. Output Current	I <sub>OUTmax</sub>	V <sub>IN</sub> =Vout+1V		500		mA
CE Enable Voltage	V <sub>CE</sub>	V <sub>IN</sub> =Vout+1V		1.1		V
Load Regulation	ΔV <sub>OUT</sub>	V <sub>IN</sub> =Vout+1V, 1mA≤I <sub>OUT</sub> ≤100mA		50		mV
Dropout Voltage (Note 3)	V <sub>dif1</sub>	I <sub>OUT</sub> =100mA		100		mV
	V <sub>dif2</sub>	I <sub>OUT</sub> =200mA		300		mV
Supply Current	I <sub>SS</sub>	V <sub>IN</sub> =Vout+1V		60		μA
Standby Current	I <sub>CEL</sub>	Vce=0V		1		μA
Line Regulation	$\frac{\Delta V_{OUT}}{\Delta V_{IN} \cdot V_{OUT}}$	I <sub>OUT</sub> =40mA Vout+1V ≤ V <sub>IN</sub> ≤ 8V		0.03		%/V
Output Noise	en	I <sub>OUT</sub> =40mA, 300Hz~50kHz		50		uVrms
Ripple Rejection Rate	PSRR	Vin= [Vout+1]V +1Vp-pAC I <sub>OUT</sub> =40mA,f=1kHz		70		dB

### TYPICAL APPLICATION

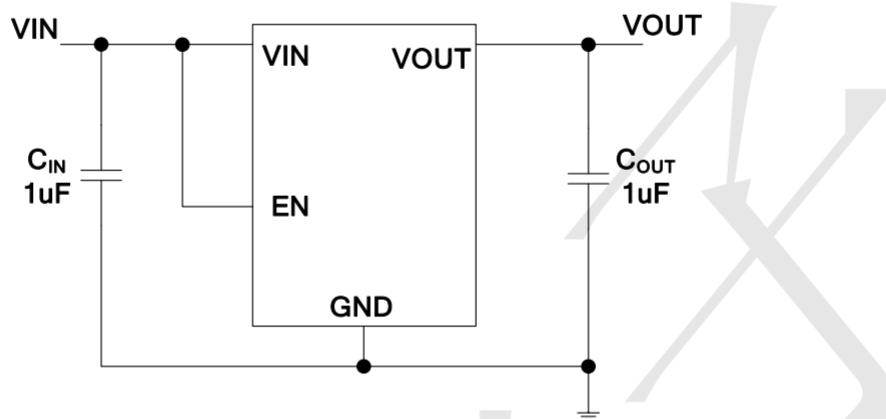

**Package informantion**

SOT23-5

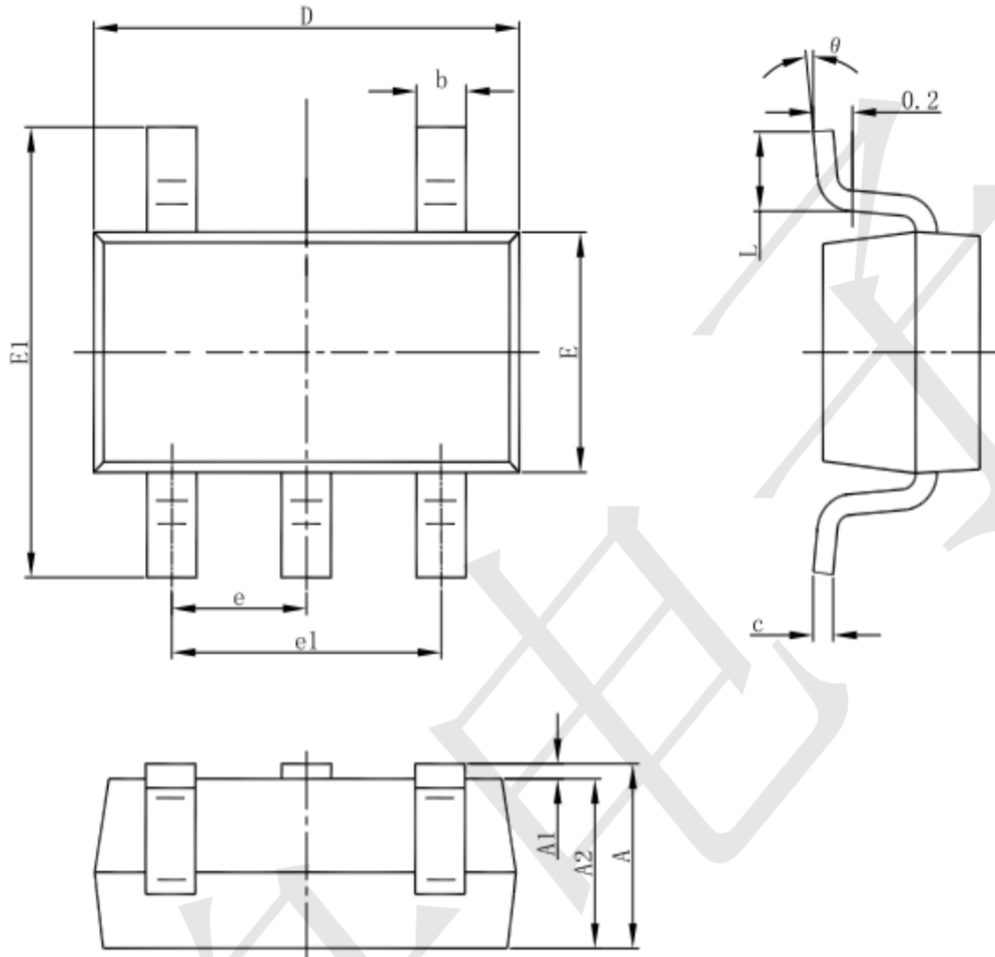

Symbol	Dimensions In Millimeters		Dimensions In Inches	
	Min	Max	Min	Max
A	1.050	1.250	0.041	0.049
A1	0.000	0.100	0.000	0.004
A2	1.050	1.150	0.041	0.045
b	0.300	0.500	0.012	0.020
c	0.100	0.200	0.004	0.008
D	2.820	3.020	0.111	0.119
E	1.500	1.700	0.059	0.067
E1	2.650	2.950	0.104	0.116
e	0.950(BSC)		0.037(BSC)	
e1	1.800	2.000	0.071	0.079
L	0.300	0.600	0.012	0.024
θ	0°	8°	0°	8°