

Parameters Subject to Change Without Notice

DESCRIPTION

The JW[®]1121A is a current mode monolithic buck LED driver. Operating with an input range of 4.2V-20V, JW1121A delivers 1.5A of continuous output current with two integrated N-Channel MOSFETs. The internal synchronous power switches provide high efficiency without the use of an external Schottky diode. It incorporates analog dimming mode and PWM signal to analog dimming mode onto a single control pin. The JW1121A guarantees robustness with LED short protection, thermal protection, start-up current run-away protection, input under voltage lockout.

The JW1121A is available in 6-pin SOT23 packages, which provide a compact solution with minimal external components.

Company's Logo is Protected, "JW" and "JOULWATT" are Registered Trademarks of JoulWatt technology Inc.

FEATURES

- 4.2V to 20V operating input range
- 1.5A output current
- Up to 94% efficiency @ Vin=12V, Vout=6V
- 1MHz Switching frequency
- PWM to Analog dimming mode
- Input under voltage lockout
- Start-up current run-away protection
- LED short protection
- Thermal protection
- Available in SOT23-6 packages

APPLICATIONS

- IP camera and CCD camera
- Flash light
- Display cabinet lamp
- LED Sign

TYPICAL APPLICATION

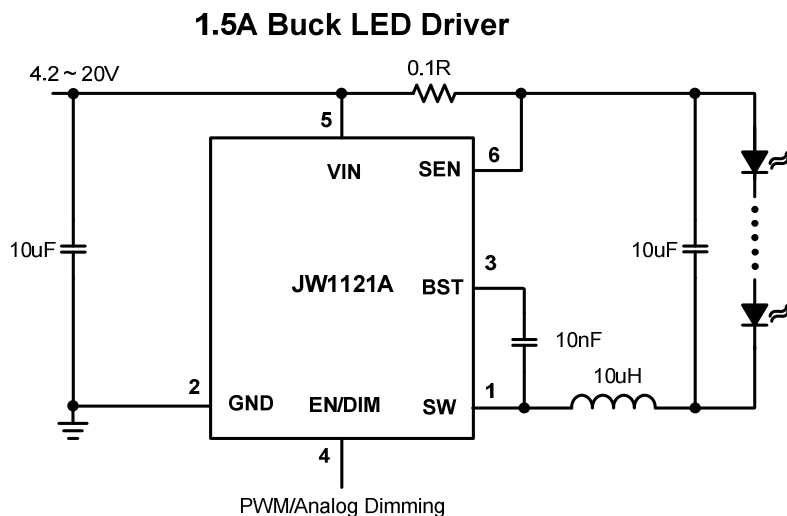

ORDER INFORMATION

DEVICE ¹⁾	PACKAGE	TOP MARKING ²⁾
JW1121ASOTB#TRPBF	SOT23-6	JWLWX YWLLL

Notes:

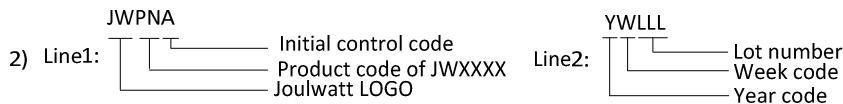

PIN CONFIGURATION

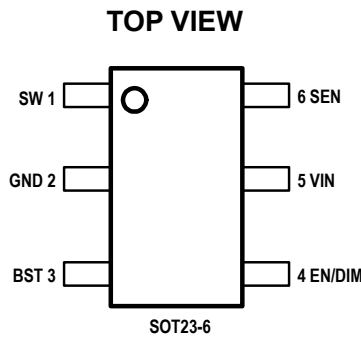

ABSOLUTE MAXIMUM RATING¹⁾

VIN ,SEN Pin	-0.3V to 28V
SW Pin	-0.3V (-2V for 10ns) to 28V
BST Pin	SW-0.3V to SW+5V
All other pins	-0.3V to 6V
Junction Temperature ^{(2) (3)}	150°C
Lead Temperature	260°C
Storage Temperature	-65 °C to +150°C

RECOMMENDED OPERATING CONDITIONS

Input Voltage VIN	4.2V to 20V
Operating Junction Temperature	-40°C to 125°C

THERMAL PERFORMANCE⁴⁾

	θ_{JA}	θ_{JC}
SOT23-6	220	110°C/W

Note:

- 1) Exceeding these ratings may damage the device.
- 2) The JW1121A guarantees robust performance from -40°C to 150°C junction temperature. The junction temperature range specification is assured by design, characterization and correlation with statistical process controls.
- 3) The JW1121A includes thermal protection that is intended to protect the device in overload conditions. Thermal

protection is active when junction temperature exceeds the maximum operating junction temperature. Continuous operation over the specified absolute maximum operating junction temperature may damage the device.

- 4) Measured on JESD51-7, 4-layer PCB.

ELECTRICAL CHARACTERISTICS

<i>V_{IN}=12V, T_A=25 °C, Unless otherwise stated</i>						
Item	Symbol	Conditions	Min.	Typ.	Max.	Unit
V _{IN} Under Voltage Lock-out Threshold	V _{IN_MIN}	V _{IN} falling		3.8		V
V _{IN} Under Voltage Lockout Hysteresis	V _{IN_MIN_HYST}	V _{IN} rising		300		mV
Shutdown Supply Current	I _{SD}	V _{EN} =0V		5		µA
Supply Current	I _Q	V _{EN} =5V, V _{FB} =1V		1		mA
Internal Reference Voltage	V _{REF}	4.2V<V _{VIN} <20V	96	100	104	mV
Top Switch Resistance ⁵⁾	R _{DS(ON)T}			130		mΩ
Bottom Switch Resistance ⁵⁾	R _{DS(ON)B}			130		mΩ
Top Switch Leakage Current	I _{LEAK_TOP}	V _{IN} =20V, V _{EN} =0V, V _{SW} =0V			1	µA
Bottom Switch Leakage Current	I _{LEAK_BOT}	V _{IN} =20V, V _{EN} =0V, V _{SW} =20V			1	µA
Bottom Switch Current Limit ⁵⁾	I _{LIM_BOT}		2.6	3.1	3.7	A
Switch Frequency	F _{SW}		0.8	1	1.2	MHz
EN/DIM rising threshold	V _{ENH}	V _{EN} rising			0.65	V
EN/DIM falling threshold	V _{ENL}	V _{EN} falling	0.3			V
Analog Dimming Signal to EN/DIM pin						
EN/DIM Analog Dimming Mode Threshold	V _{A_ADIM}	Analog dimming	0.62	0.65	0.67	V
EN/DIM Analog Dimming Accuracy	I _{LED,ACC}	V _{EN/DIM} =0.65V		0%		
		V _{EN/DIM} =1.2V		100%		
PWM Dimming Signal to EN/DIM pin						
EN/DIM PWM/Analog Dimming Mode Threshold	V _{PWM_ADIM}	Rising	1.9	2	2.1	V
		Falling		1.8		V
Minimum on-time	T _{ON-MIN}			100		ns
Minimum off-time	T _{OFF-MIN}			60		ns
Maximum Duty Cycle	D _{MAX}			100		%
Thermal Shutdown ⁵⁾	T _{TSD}			150		°C
Thermal Shutdown hysteresis ⁵⁾	T _{TSD_HYST}			20		°C

Note:

5) Guaranteed by design.

PIN DESCRIPTION

Pin	Name	Description
1	SW	SW is the switching node that supplies power to the output. Connect the output LC filter from SW to the output load.
2	GND	Ground.
3	BST	Bootstrap pin for top switch. A 0.01uF capacitor should be connected between this pin and the SW pin to supply current to the top switch and top switch driver.
4	EN/DIM	Drive EN pin above 0.65V to enable the LED driver. When EN/DIM pin voltage rises from 0.65V to 1.2V, the LED current will change from 1% to 100% of the maximum LED current. When EN/DIM pin is supplied by a PWM signal and its amplitude is higher than 2V, PWM to Analog dimming mode will be chosen.
5	VIN	Input voltage pin. VIN supplies power to the IC. Connect a 4.2V to 20V supply to VIN and bypass VIN to GND with a suitably large capacitor to eliminate noise on the input to the IC.
6	SEN	Negative current sense pin.

BLOCK DIAGRAM

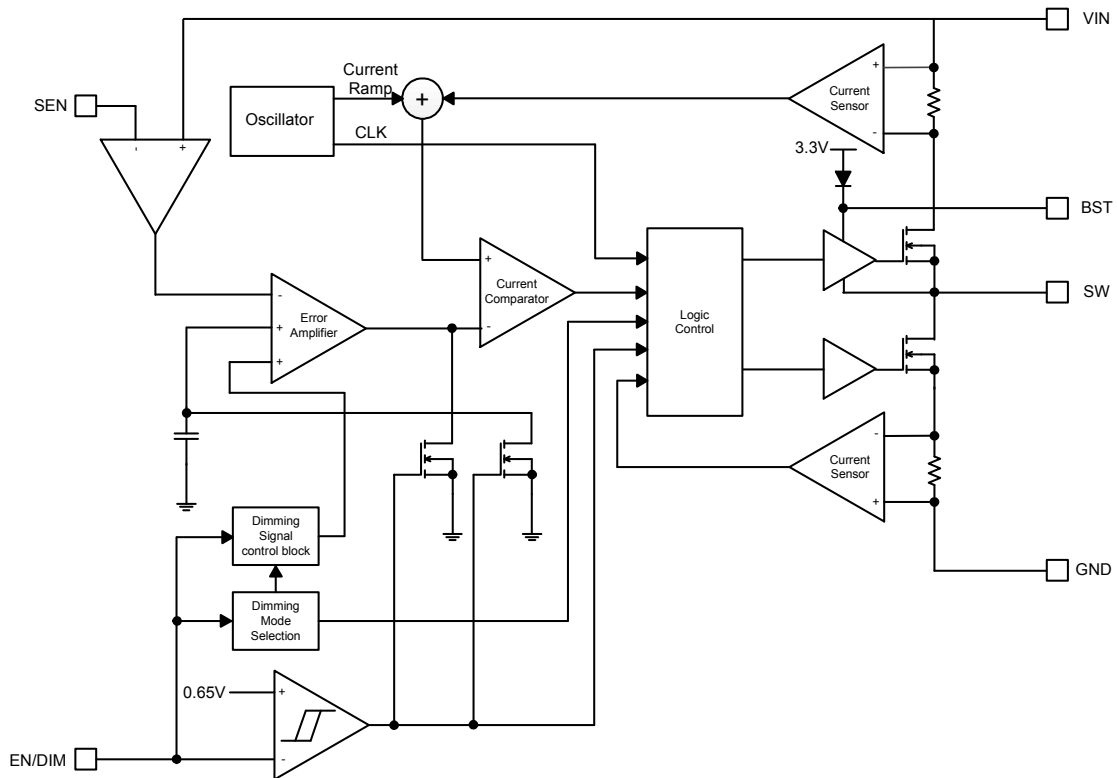

TYPICAL PERFORMANCE CHARACTERISTICS

Shutdown Current Vs. Input Voltage

VEN=3V

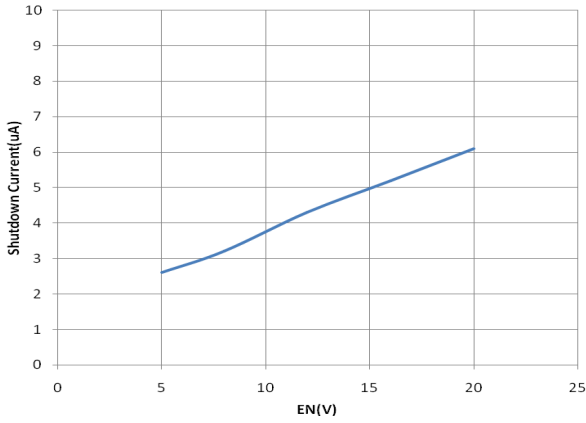

Quiescent Current Vs. Input Voltage

VEN=3V

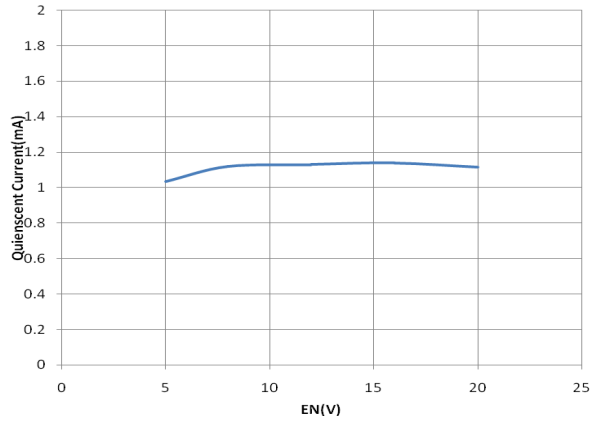

Line Regulation

VIN=12V, VEN=3V, Vout=4V, L=4.7µH

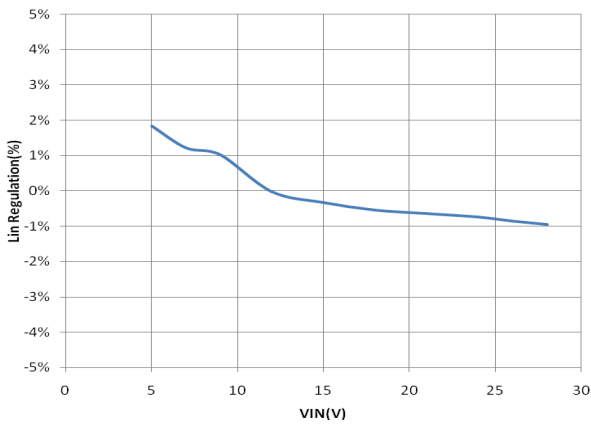

Efficiency vs. Vin

2LED in series, L=4.7µH

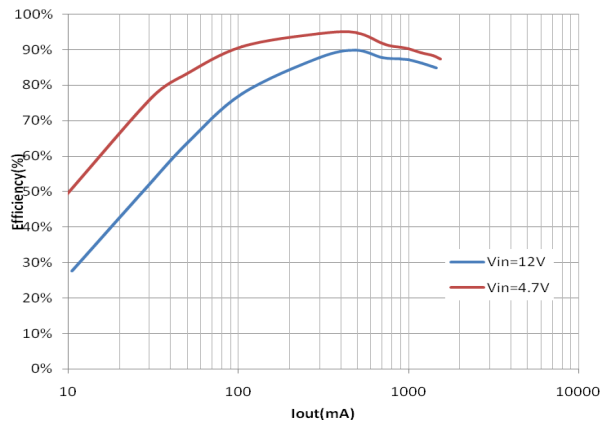

Efficiency vs. Iout

1LED in series, L=4.7µH

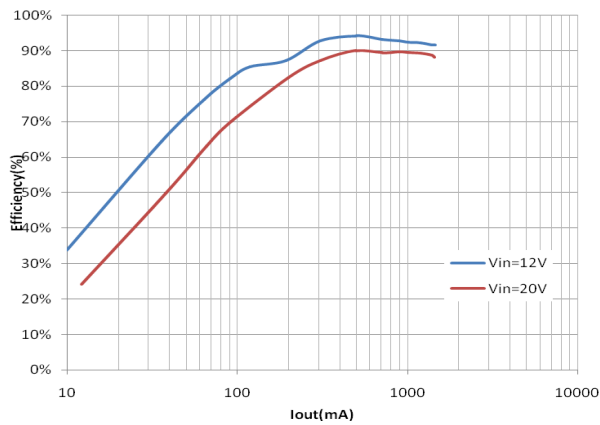

PWM to Analog DIMMING

Duty cycle VS Output Current

VIN=12V, Vout=2#LED PWM=1kHz

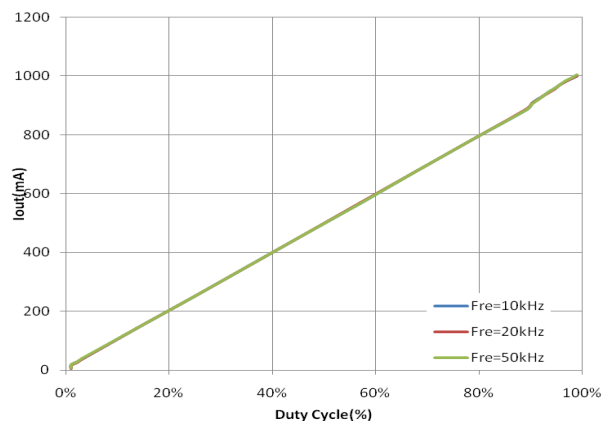

TYPICAL PERFORMANCE CHARACTERISTICS(continued)

Analog Dimming
ILED VS EN/DIM Voltage
VIN=12V, Vout=2#LED

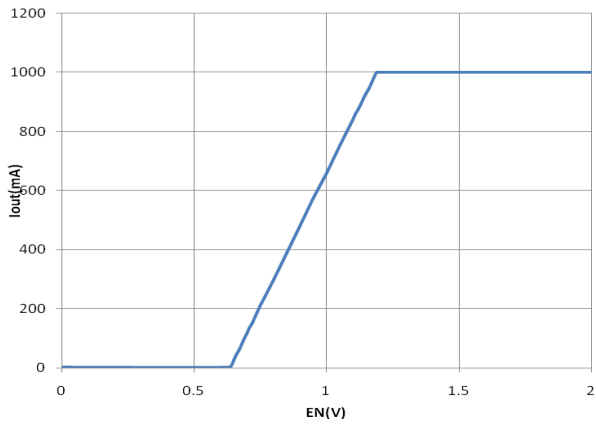

TYPICAL PERFORMANCE CHARACTERISTICS(continued)

Vin =12V, Vout = 2#LED, L = 4.7μH, Cout = 10μF, TA = +25°C, unless otherwise noted

Steady State Test

VIN=12V, Vout=2#LED
Iout=0.1A

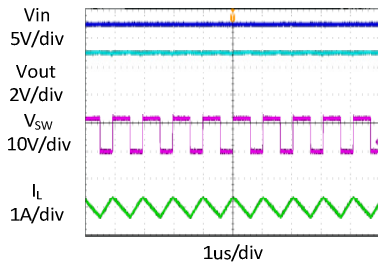

Steady State Test

VIN=12V, Vout=2#LED
Iout=0.75A

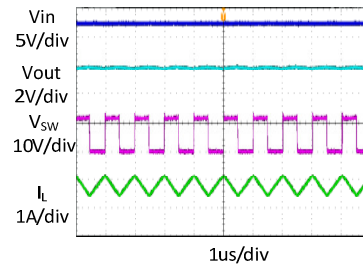

Steady State Test

VIN=12V, Vout=2#LED
Iout=1.5A

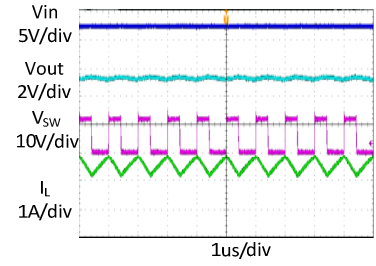

Startup through Enable

VIN=12V, Vout=2#LED
Iout=1.5A

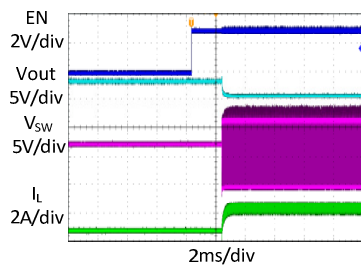

Shutdown through Enable

VIN=12V, Vout=2#LED
Iout=1.5A

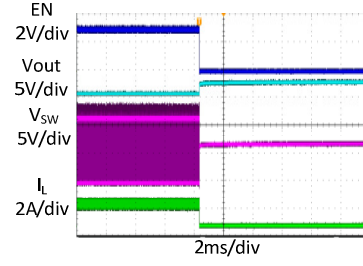

Short LED+ to LED- Protection

VIN=12V, Vout=2#LED
Iout=1.5A- Short

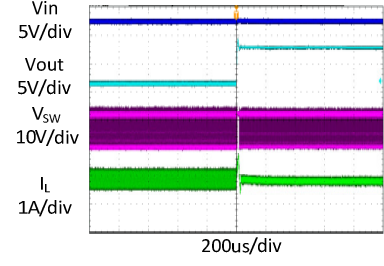

Short LED+ to LED- Recovery

VIN=12V, LED+ short to LED-,
Recovery

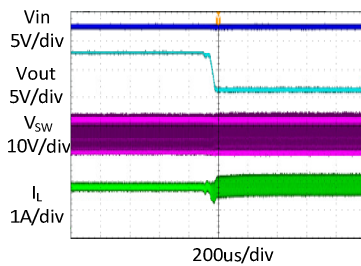

Open LED Load Protection

VIN=12V, Vout=2#LED
Iout=1.5A- open

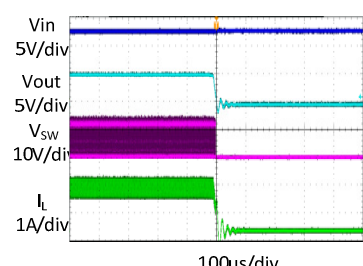

Open LED Load Recovery

VIN=12V, Vout=2#LED
Iout=1.5A

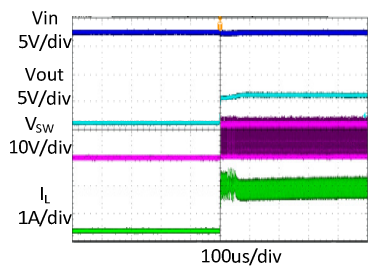

TYPICAL PERFORMANCE CHARACTERISTICS *(continued)*

Vin =12V, Vout = 2#LED, L = 4.7μH, Cout = 22μF, TA = +25°C, unless otherwise noted

PWM Dimming

VIN=12V, Vout=2#LED
PWM=1kHz, 1%

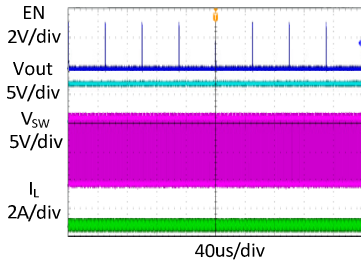

PWM Dimming

VIN=12V, Vout=2#LED
PWM=1kHz,50%

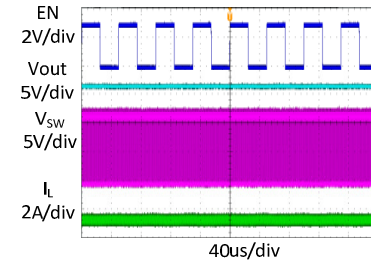

PWM Dimming

VIN=12V, Vout=2#LED
PWM=1kHz,99%

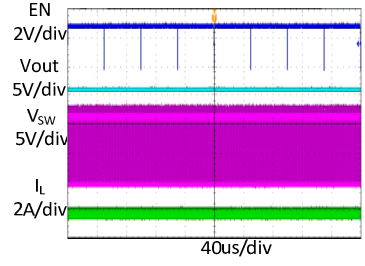

FUNCTIONAL DESCRIPTION

The JW1121A is a synchronous, current-mode buck LED driver capable of supplying up to 1.5A of load current.

Voltage-Mode Control

The JW1121A utilizes voltage-mode control to regulate the SENSE voltage. Voltage between VIN pin and SENSE pin is regulated at 0.1V so that by connecting a resistor between VIN pin and SENSE pin, maximum current through the LED string can be accurately controlled.

FCC Mode

The frequency of JW1121A keeps constant at all load range for low output current ripple.

Shut-Down Mode

The JW1121A operates in shut-down mode when voltage at EN pin is driven below 0.3V. In shut-down mode, the entire regulator is off and the supply current consumed by the JW1121A drops below 5uA.

Dimming Mode Selection

Once a analog dimming signal or a PWM dimming signal is applied to EN/DIM pin, the internal peak detector at EN/DIM pin will hold the magnitude of the dimming signal. Once the device is enabled, after 300us delay, the output of the peak detector will be compared with three voltage thresholds V_{A_ADIM} and V_{PWM_ADIM} , which is 0.65V, 1.2V and 2V respectively. If the output of peak detector is higher than 2V, PWM signal to Analog dimming mode will be chosen and locked. If it is lower than 1.2V and higher than 0.65V, Analog dimming mode will be chosen and locked. If it is less than 0.65V, the device will wait another 300us and compare again, and this process will repeat until one mode is chosen

and locked. (Shown as figure1 and table 1)

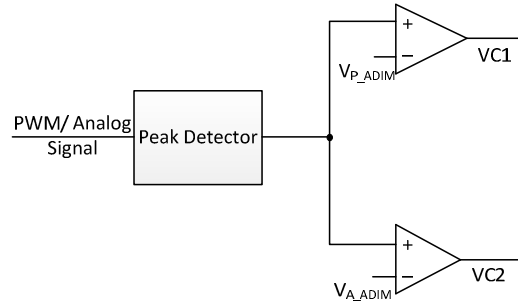

Figure 1. Dimming Mode Selection Circuit

Table 1. Dimming Mode Selection

VC1	VC2	MODE
H	H	PWM to Analog Dimming Mode
L	H	Analog Dimming Mode
L	L	Keep detecting until one mode is selected and locked

Analog Dimming

Once analog dimming is chosen, the internal voltage reference for FB pin will be proportional to the analog dimming signal and the current through LED string can be controlled by the analog voltage at the EN/DIM pin. Voltage below 0.65V leads to very small LED current, while voltage above 1.2V corresponds to full LED current. In between 0.65V and 1.2V, the LED current changes proportionally to the EN/DIM voltage.

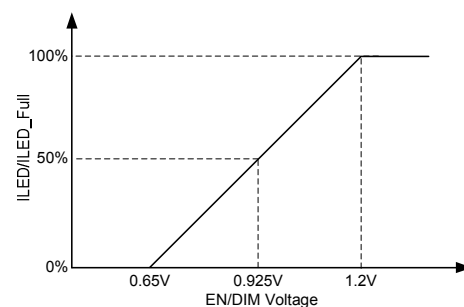

Figure 2. Analog Dimming Mode Operation

PWM / Analog Dimming Mode

Once PWM signal to analog dimming mode is chosen, the internal voltage reference will be proportional to PWM duty cycle as shown as figure 3. LED current is continuous in this mode, and the current magnitude can be adjusted by changing PWM duty cycle. Since the internal voltage reference is filtered from PWM signal, too low PWM frequency may cause a little big ripple at voltage reference. To minimize this ripple, PWM signal frequency is recommended to be higher than 10kHz, such as 50kHz.

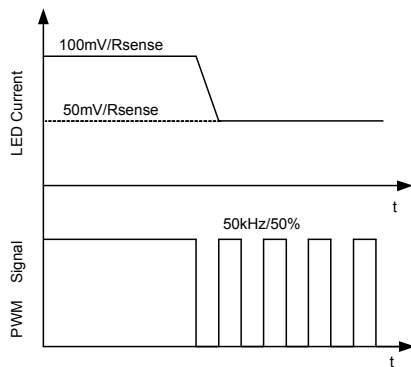

Figure 3. PWM/Analog Dimming Mode Operation

Power Switch

N-Channel MOSFET switches are integrated on the JW1121A to down convert the input voltage to the regulated output voltage. Since the top MOSFET needs a gate voltage great than the input voltage, a boost capacitor connected

between BST and SW pins is required to drive the gate of the top switch. The boost capacitor is charged by the internal 3.3V rail when SW is low.

Output Current Run-Away Protection

At start-up, due to the high voltage at input and low voltage at output, current inertia of the output inductor can be easily built up, resulting in a large start-up output current. A valley current limit is designed in the JW1121A so that only when output current drops below the valley current limit can the bottom power switch be turned off. By such control mechanism, the output current at start-up is well controlled.

Thermal Protection

When the temperature of the JW1121A rises above 150°C, it is forced into thermal shut-down. Only when core temperature drops below 130°C can the regulator becomes active again.

E-Fuse Trim

JW1121A utilizes E-Fuse as trim bit to achieve high reliability and high accuracy of LED current.

PACKAGE OUTLINE

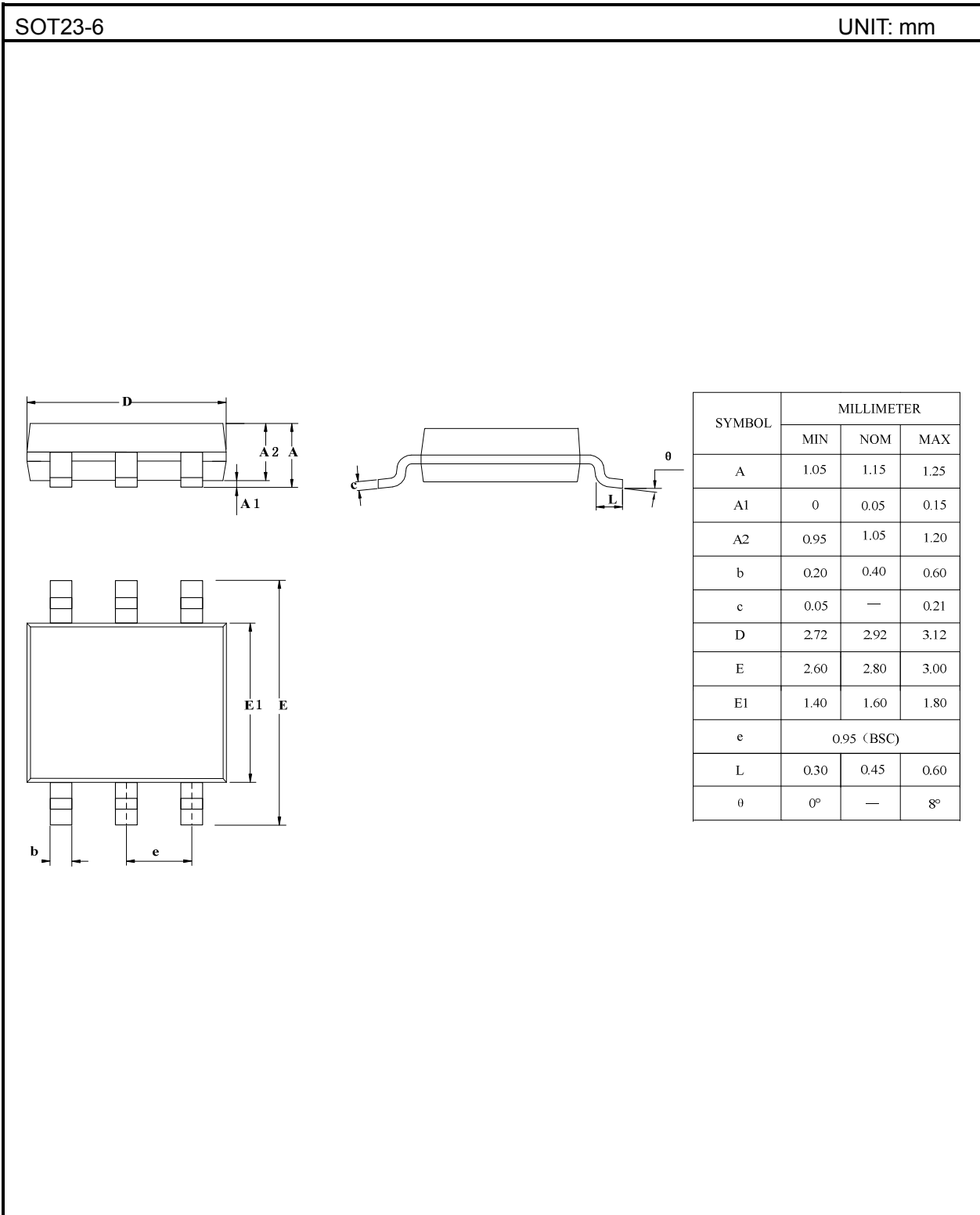

IMPORTANT NOTICE

- Joulwatt Technology Inc. reserves the right to make modifications, enhancements, improvements, corrections or other changes without further notice to this document and any product described herein.
- Any unauthorized redistribution or copy of this document for any purpose is strictly forbidden.
- Joulwatt Technology Inc. does not warrant or accept any liability whatsoever in respect of any products purchased through unauthorized sales channel.

Copyright © 2017 JW1121A Incorporated.

All rights are reserved by Joulwatt Technology Inc.