

Data sheet | Item number: 286-328

Relay module; Nominal input voltage: 24 VDC; 2 make contact; Limiting continuous current: 6 A; Red status indicator; Module width: 20 mm

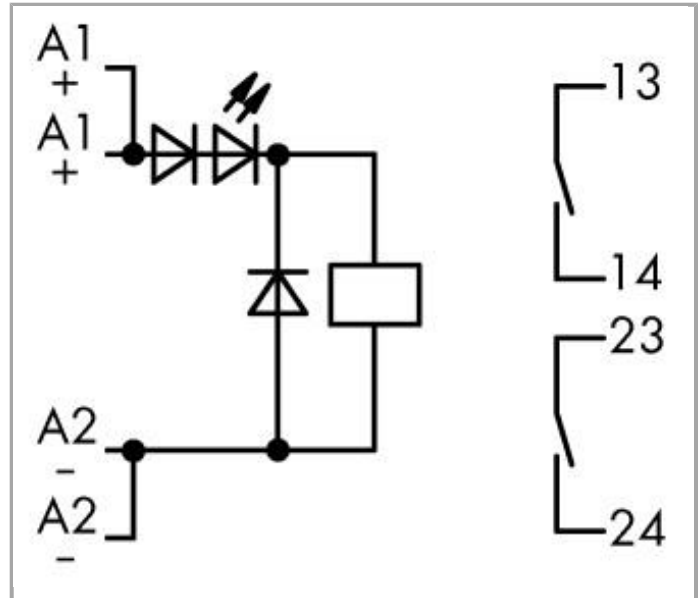

[www.wago.com/286-328](http://www.wago.com/286-328)



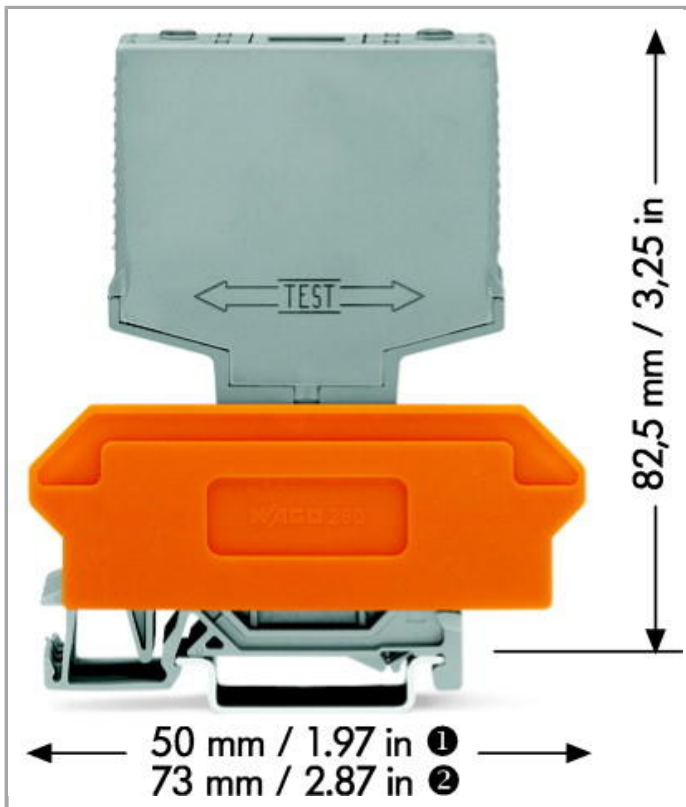

## Data

## Technical Data

## Control circuit

Nominal input voltage $U_N$	24 VDC
Nominal input current at $U_N$	7.4 mA

## Load circuit:

Number of make contacts/switch on contacts	2
Contact material (relay)	AgSnO <sub>2</sub>
Limiting continuous current	6 A
Max. make current (resistive)	1 s 15 A (AC)
Max. switching voltage	250 VAC
Max. switching power (resistive)	1500 VAAC
Pull-in time (typ.)	10 ms
Drop-out time (typ.)	4 ms
Bounce time (typ)	1 ms
Electrical life (N.O.; resistive load; 23 °C)	100 x 10 <sup>3</sup> switching operations
Mechanical life (N.O.; resistive load; 23 °C)	50 x 10 <sup>6</sup> switching operations

## Signaling

Status indication	LED red
-------------------	---------

## Safety and protection:

Rated voltage	250 V
Rated impulse voltage	4 kV
Pollution degree	2
Dielectric strength, control/load circuit (AC, 1 min)	3 kV <sub>rms</sub>
Dielectric strength, control/load circuit (AC, 1 min)	3 kV <sub>rms</sub>
Dielectric strength open contact (AC, 1 min)	1 kV <sub>rms</sub>
Dielectric strength open contact (AC, 1 min)	1 kV <sub>rms</sub>
Dielectric strength, load/load circuit (AC, 1 min)	1.5 kV <sub>rms</sub>
Dielectric strength, load/load circuit (AC, 1 min)	1.5 kV <sub>rms</sub>
Degree of protection	IP20

## Geometrical Data

Width	20 mm / 0.787 inch
Height from upper-edge of DIN-35 rail	82.5 mm / 3.248 inch
Depth	52 mm / 1.654 inch

## Mechanical data

Type of mounting	Pluggable module for carrier terminal blocks
------------------	--

## Material Data

Color	gray
Fire load	0.65 MJ
Weight	28.5 g

## Environmental Requirements

Surrounding air (operating) temperature at U <sub>N</sub>	-25 ... 40 °C
Pollution degree	2

## Standards and specifications









Standards/specifications	EN 60664-1
--------------------------	------------

## Commercial data



Country of origin	DE
GTIN	4045454319540
Product Group	6 (Interface Electronics)

## Compatible products

### Marking accessories

	<b>Item no.: 209-701</b> WSB marking card; as card; not stretchable; plain; snap-on type	<a href="http://www.wago.com/209-701">www.wago.com/209-701</a>
	<b>Item no.: 209-701/000-002</b> WSB marking card; as card; not stretchable; plain; snap-on type	<a href="http://www.wago.com/209-701/000-002">www.wago.com/209-701/000-002</a>
	<b>Item no.: 209-701/000-005</b> WSB marking card; as card; not stretchable; plain; snap-on type	<a href="http://www.wago.com/209-701/000-005">www.wago.com/209-701/000-005</a>
	<b>Item no.: 209-701/000-006</b> WSB marking card; as card; not stretchable; plain; snap-on type	<a href="http://www.wago.com/209-701/000-006">www.wago.com/209-701/000-006</a>
	<b>Item no.: 209-701/000-007</b> WSB marking card; as card; not stretchable; plain; snap-on type	<a href="http://www.wago.com/209-701/000-007">www.wago.com/209-701/000-007</a>
	<b>Item no.: 209-701/000-012</b> WSB marking card; as card; not stretchable; plain; snap-on type	<a href="http://www.wago.com/209-701/000-012">www.wago.com/209-701/000-012</a>
	<b>Item no.: 209-701/000-017</b> WSB marking card; as card; not stretchable; plain; snap-on type	<a href="http://www.wago.com/209-701/000-017">www.wago.com/209-701/000-017</a>
	<b>Item no.: 209-701/000-023</b> WSB marking card; as card; not stretchable; plain; snap-on type	<a href="http://www.wago.com/209-701/000-023">www.wago.com/209-701/000-023</a>
	<b>Item no.: 209-701/000-024</b> WSB marking card; as card; not stretchable; plain; snap-on type	<a href="http://www.wago.com/209-701/000-024">www.wago.com/209-701/000-024</a>

### General accessories

	<b>Item no.: 280-628</b> Terminal block for pluggable modules; 4-conductor; 22 mm; Orange separator plate	<a href="http://www.wago.com/280-628">www.wago.com/280-628</a>
	<b>Item no.: 280-638</b> Terminal block for pluggable modules; 2-conductor; 22 mm; Orange separator plate	<a href="http://www.wago.com/280-638">www.wago.com/280-638</a>
	<b>Item no.: 280-764</b> Terminal block for pluggable modules; 4-conductor; 25 mm; Orange marker plate	<a href="http://www.wago.com/280-764">www.wago.com/280-764</a>



Downloads

Documentation

Additional Information

---

Disposal; Electrical and electronic equipment, Packaging	Oct 15, 2018	265.8 kB	Download
--	--------------	----------	----------

---

CAD files

CAD data

---

3D Download 286-328	URL	Download
---------------------	-----	----------

---

Subject to changes.

---

WAGO Corporation  
Germantown, WI 53022  
32423 Minden  
Phone: +49571 887-0 | Fax: (262) 255-6222  
Email: [info.us@wago.com](mailto:info.us@wago.com) | Web: [www.wago.com](http://www.wago.com)

Do you have any questions about our products?  
We are always happy to take your call at {0}.