

- Features:
- Thin film technology for precision and stability
 - Excellent power to size ratio
 - Outstanding pulse handling
 - Excellent overall stability
 - Sn termination on Ni barrier layer
 - Tight tolerance down to $\pm 0.1\%$
 - Extremely low TCR down to $\pm 15 \text{ppm}/^\circ\text{C}$
 - High power rating up to 1 Watt
 - SMD enabled structure
 - AEC-Q200 qualified
 - RoHS compliant, lead-free and halogen-free



Electrical Specifications									
Type/Code	Package Size	Power Rating (Watts) @ 70°C	Maximum Working Voltage ⁽¹⁾	Maximum Overload Voltage ⁽²⁾	Resistance Temperature Coefficient	Ohmic Range (Ω) and Tolerance			
						0.1%	0.5%	1%	5%
MLFA13 ⁽³⁾	0102	0.3W	200V	400V	$\pm 50 \text{ppm}/^\circ\text{C}$	-	8.2 - 1M		
					$\pm 100 \text{ppm}/^\circ\text{C}$	-	8.2 - 1M		
		Jumper: 2A	-	0 Ω (<15m Ω)					
MLFA25	0204	0.4W	200V	400V	$\pm 15 \text{ppm}/^\circ\text{C}$	10 - 300K			
					$\pm 25 \text{ppm}/^\circ\text{C}$	10 - 1M			
					$\pm 50 \text{ppm}/^\circ\text{C}$	10 - 1M	1 - 1M	0.2 - 1M	
					$\pm 100 \text{ppm}/^\circ\text{C}$	-	0.1 - 1M		
		Jumper: 2A	-	0 Ω (<15m Ω)					
MLFA1	0207	1W	350V	700V	$\pm 15 \text{ppm}/^\circ\text{C}$	10 - 300K			
					$\pm 25 \text{ppm}/^\circ\text{C}$	10 - 1M			
					$\pm 50 \text{ppm}/^\circ\text{C}$	10 - 1M	1 - 1M	0.2 - 1M	
					$\pm 100 \text{ppm}/^\circ\text{C}$	-	0.1 - 1M		
		Jumper: 4A	-	0 Ω (<15m Ω)					

⁽¹⁾ Working Voltage = $\sqrt{P \cdot R}$ or Max. Operating Voltage listed above, whichever is lower.

⁽²⁾ Overload Voltage = $2.5 \cdot \sqrt{P \cdot R}$ or Max. Overload Voltage listed above, whichever is lower.

⁽³⁾ Lower TCR with lower Power Ratings may be available - contact factory

Mechanical Specifications

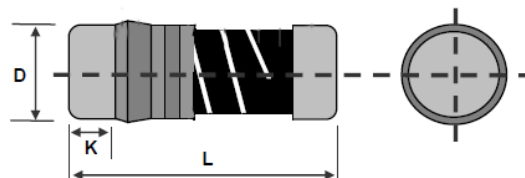

Type/Code	Weight (g) (1000 pc)	L Body Length	D Body Diameter	K Termination	Unit
MLFA13	7.7	0.087 \pm 0.004	0.043 \pm 0.004	0.018 \pm 0.002	inches
		2.20 \pm 0.10	1.10 \pm 0.10	0.45 \pm 0.05	mm
MLFA25	18.7	0.138 \pm 0.008	0.055 \pm 0.006	0.031 \pm 0.004	inches
		3.50 \pm 0.20	1.40 \pm 0.15	0.80 \pm 0.10	mm
MLFA1	80.9	0.232 \pm 0.008	0.087 \pm 0.008	0.051 \pm 0.004	inches
		5.90 \pm 0.20	2.20 \pm 0.20	1.30 \pm 0.10	mm

Operating Temperature Range: -55 ~ +155°C

Power Derating Curve:

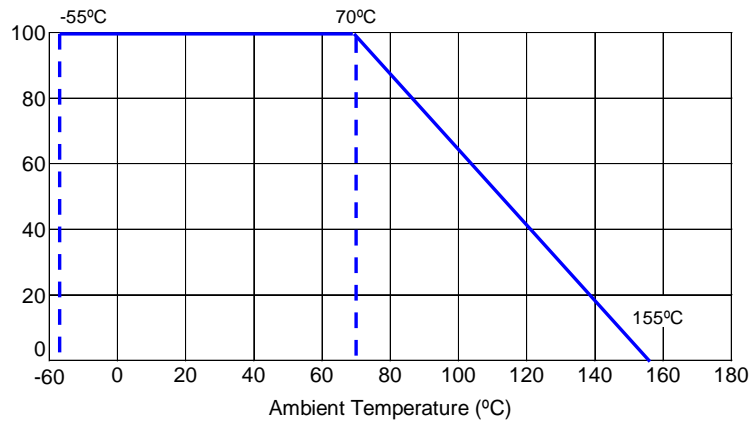

Performance Characteristics		
Test	Test Method	Test Specification
Temperature Coefficient of Resistance (T.C.R.)	JIS-C-5201-1 4.8 IEC-60115-1 4.8 -55°C ~ +125°C, 25°C is the reference temperature	As specified
Short Time Overload	JIS-C-5201-1 4.13 IEC-60115-1 4.13 RCWV*2.5 or max. overload voltage whichever is lower for 5 seconds	10Ω-270KΩ:±(0.1%+0.05Ω) <10Ω&>270KΩ:±(0.15%+0.05Ω) MLFA13: ±(0.15%+0.05Ω)
Insulation Resistance	JIS-C-5201-1 4.6 IEC-60115-1 4.6 Max. overload voltage for 1 minute	≥10G
Endurance	JIS-C-5201-1 4.25 IEC-60115-1 4.25.1 70±2°C, RCWV for 1000 hours with 1.5 hour "ON" and 0.5 hour "OFF"	10Ω-270KΩ:±(0.25%+0.05Ω) <10Ω&>270KΩ:±(0.5%+0.05Ω) MLFA13: ±(0.5%+0.05Ω)
Biased Humidity	MIL-STD-202 Method 103 1000 hours 85°C/85% RH 10% of operating power	10Ω-270KΩ:±(0.5%+0.05Ω) <10Ω&>270KΩ:±(1%+0.05Ω) MLFA13: ±(2%+0.05Ω)
High Temperature Exposure	MIL-STD-202 Method 108 at +155°C for 1000 hours	10Ω-270KΩ:±(0.25%+0.05Ω) <10Ω&>270KΩ:±(0.5%+0.05Ω) MLFA13: ±(1%+0.05Ω)
Board Flex	AEC-Q200-005 Bending once for 60 seconds with 2mm	10Ω-270KΩ:±(0.1%+0.05Ω) <10Ω&>270KΩ:±(0.5%+0.05Ω) MLFA13: ±(0.5%+0.05Ω)
Solderability	JIS-C-5201-1 4.17 IEC-60115-1 4.17 J-STD-002 245±5°C for 3 seconds	95% min. coverage
Resistance to Soldering Heat	MIL-STD-202 Method 210 260±5°C for 10 seconds	10Ω-270KΩ:±(0.1%+0.05Ω) <10Ω&>270KΩ:±(0.25%+0.05Ω) MLFA13: ±(0.25%+0.05Ω)
Voltage Proof	JIS-C-5201-1 4.7 IEC-60115-1 4.7 1.42 times max. operating voltage for 1 minute	No breakdown or flashover

Performance Characteristics (cont.)		
Test	Test Method	Test Specification
Leaching	JIS-C-5201-1 4.18 IEC-60068-2-58 8.2.1 260±5°C for 30 seconds	Individual leaching area ≤5% Total leaching area ≤10%
Temperature Cycling	JESD22 Method JA-104 -55°C to +125°C, 1000 cycles	10Ω-270KΩ:±(0.25%+0.05Ω) <10Ω>270KΩ:±(0.5%+0.05Ω) MLFA13: ±(1%+0.05Ω)
Mechanical Shock	MIL-STD-202 Method 213 Wave Form: Tolerance for half sine shock pulse. Peak value is 100g's. Normal duration (D) is 6.	±(0.25%+0.05Ω)
Vibration	MIL-STD-202 Method 204 5 g's for 20 minutes., 12 cycles each of 3 orientations, 10-2000 Hz	±(0.5%+0.05Ω)
ESD	AEC-Q200-002 Human body, 2KV	±(0.5%+0.05Ω)
Resistance to Solvents	MIL-STD-202 Method 215 Add aqueous wash chemical - OKEM clean or equivalent. Do not use banned solvents.	No visible damage on appearance and marking.
Terminal Strength	AEC-Q200-006 Force of 1.8 Kg for 60 seconds	No breakage
Flammability	UL-94 V-0 or V-1 are acceptable. Electrical test not required.	No ignition of the tissue paper or scorching of the pinewood board

RCWV (rated continuous working voltage) = $\sqrt{P \cdot R}$ or max. operating voltage whichever is lower.

Storage temperature: 15~28 °C. Humidity < 80% R.H.

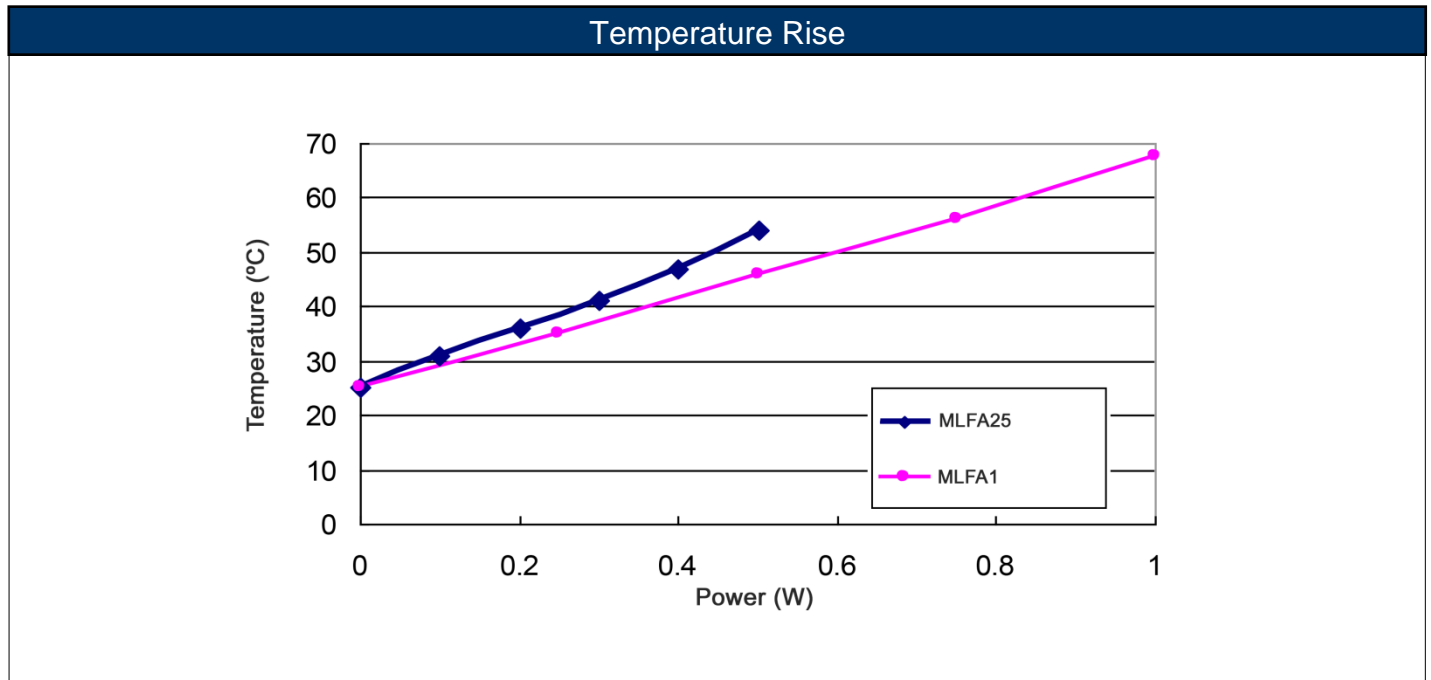

Reel Specifications

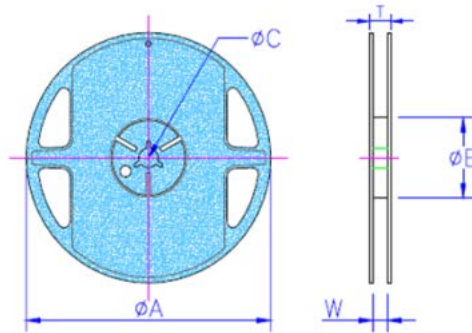

Type/Code	Reel Diameter	ϕA	ϕB	ϕC	W	T	Unit
MLFA13	0.276	7.028 ± 0.059	2.362 ± 0.039	0.512 ± 0.008	0.354 ± 0.020	0.492 ± 0.020	inches
	7.00	178.50 ± 1.50	60.00 ± 1.00	13.00 ± 0.20	9.00 ± 0.50	12.50 ± 0.50	mm
MLFA25	0.276	7.028 ± 0.059	2.362 ± 0.039	0.512 ± 0.008	0.354 ± 0.020	0.492 ± 0.020	inches
	7.00	178.50 ± 1.50	60.00 ± 1.00	13.00 ± 0.20	9.00 ± 0.50	12.50 ± 0.50	mm
MLFA1	0.276	7.028 ± 0.059	2.362 ± 0.039	0.512 ± 0.020	0.512 ± 0.020	0.610 ± 0.020	inches
	7.00	178.50 ± 1.50	60.00 ± 1.00	13.00 ± 0.50	13.00 ± 0.50	15.50 ± 0.50	mm

Packaging Specifications - Embossed Plastic Tape

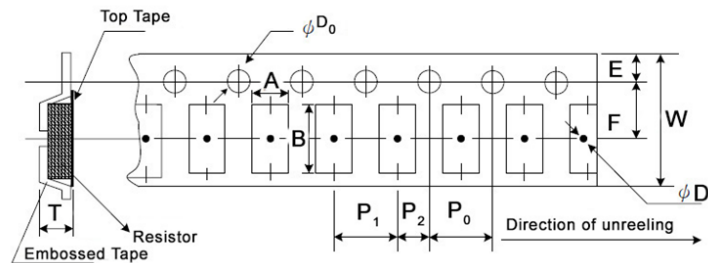

Type/Code	A	B	W	E	F	P0	Unit
MLFA13	0.051 ± 0.004	0.094 ± 0.004	0.315 ± 0.004	0.069 ± 0.004	0.138 ± 0.002	0.157 ± 0.004	inches
	1.30 ± 0.10	2.40 ± 0.10	8.00 ± 0.10	1.75 ± 0.10	3.50 ± 0.05	4.00 ± 0.10	mm
MLFA25	0.061 ± 0.004	0.144 ± 0.004	0.315 ± 0.004	0.069 ± 0.004	0.138 ± 0.002	0.157 ± 0.004	inches
	1.55 ± 0.10	3.65 ± 0.10	8.00 ± 0.10	1.75 ± 0.10	3.50 ± 0.05	4.00 ± 0.10	mm
MLFA1	0.094 ± 0.004	0.242 ± 0.004	0.472 ± 0.004	0.069 ± 0.004	0.217 ± 0.002	0.157 ± 0.004	inches
	2.40 ± 0.10	6.15 ± 0.10	12.00 ± 0.10	1.75 ± 0.10	5.50 ± 0.05	4.00 ± 0.10	mm

Type/Code	P1	P2	D0	D1	T	Unit
MLFA13	0.157 ± 0.004	0.079 ± 0.002	0.059 ± 0.004	0.035 min.	0.059 ± 0.004	inches
	4.00 ± 0.10	2.00 ± 0.05	1.50 ± 0.10	0.90 min.	1.50 ± 0.10	mm
MLFA25	0.157 ± 0.004	0.079 ± 0.002	0.059 ± 0.004	0.035 min.	0.071 ± 0.004	inches
	4.00 ± 0.10	2.00 ± 0.05	1.50 ± 0.10	0.90 min.	1.80 ± 0.10	mm
MLFA1	0.157 ± 0.004	0.079 ± 0.002	0.059 ± 0.004	0.055 min.	0.106 ± 0.004	inches
	4.00 ± 0.10	2.00 ± 0.05	1.50 ± 0.10	1.40 min.	2.70 ± 0.10	mm

Recommended Pad Layout				
Type/Code	A	B	C	Unit
MLFA13	0.039	0.031	0.059	inches
	1.00	0.80	1.50	mm
MLFA25	0.063	0.047	0.063	inches
	1.60	1.20	1.60	mm
MLFA1	0.118	0.067	0.094	inches
	3.00	1.70	2.40	mm

Soldering Condition:

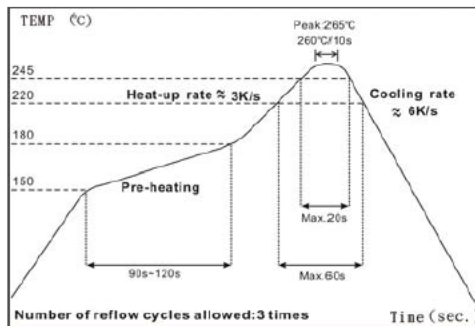

IR Reflow Soldering

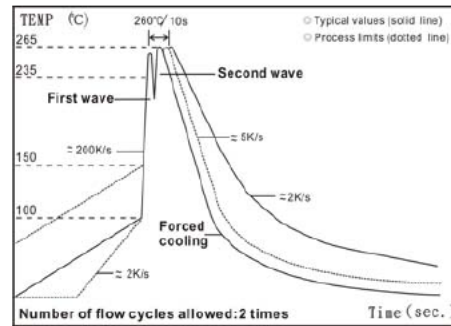

Wave Soldering (Flow Soldering)

- (1) Time of IR reflow soldering at maximum temperature point 260°C : 10s
- (2) Time of wave soldering at maximum temperature point 260°C : 10s
- (3) Time of soldering iron at maximum temperature point 410°C : 5s

Pulse Withstanding Capacity

The single impulse graph is the result of 50 impulses of rectangular shape applied at one-minute intervals. The limit of acceptance was a shift in resistance of less than 1% from the initial value. The power applied was subject to the restrictions of the maximum permissible impulse voltage graph shown.

MLFA13 Single Pulse

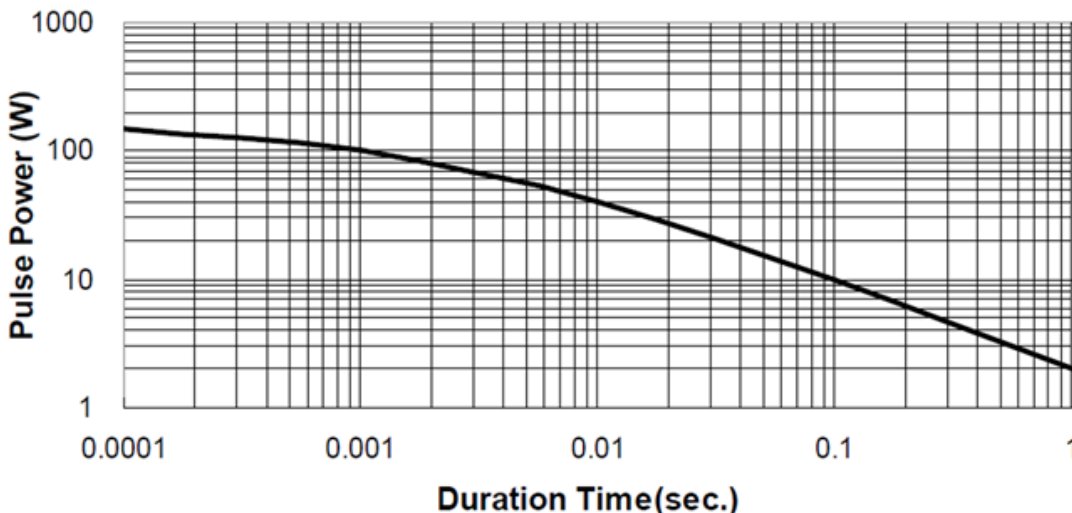

MLFA25/MLFA1 Single Pulse (100 Ohm)

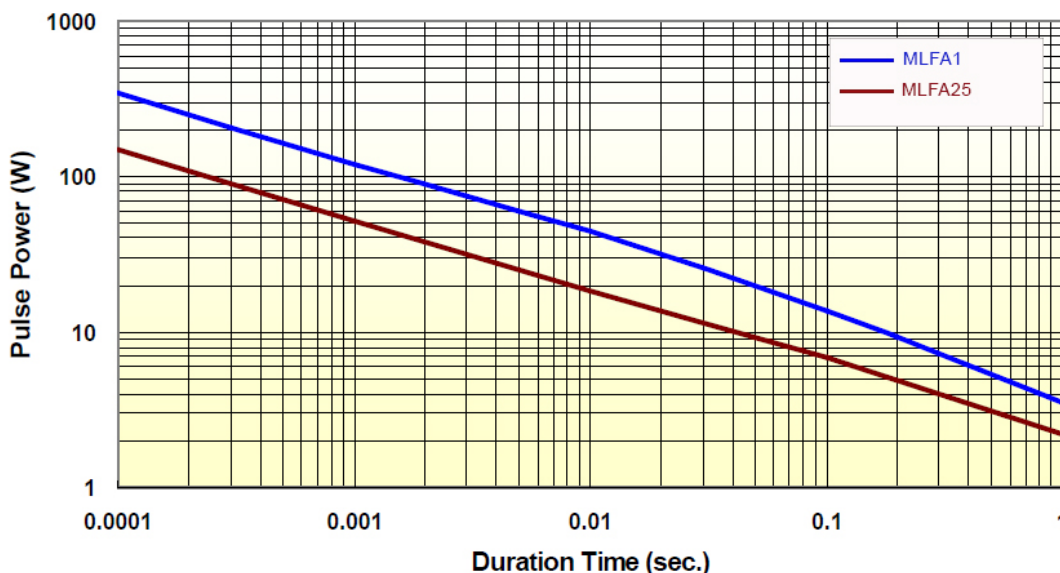

Continuous Pulse

The continuous load graph was obtained by applying repetitive rectangular pulses where the pulse period was adjusted so that the average power dissipated in the resistor was equal to its rated power at 70°C. Again the limit of acceptance was a shift in resistance of less than 1% from the initial value.

MLFA13 Continuous Pulse

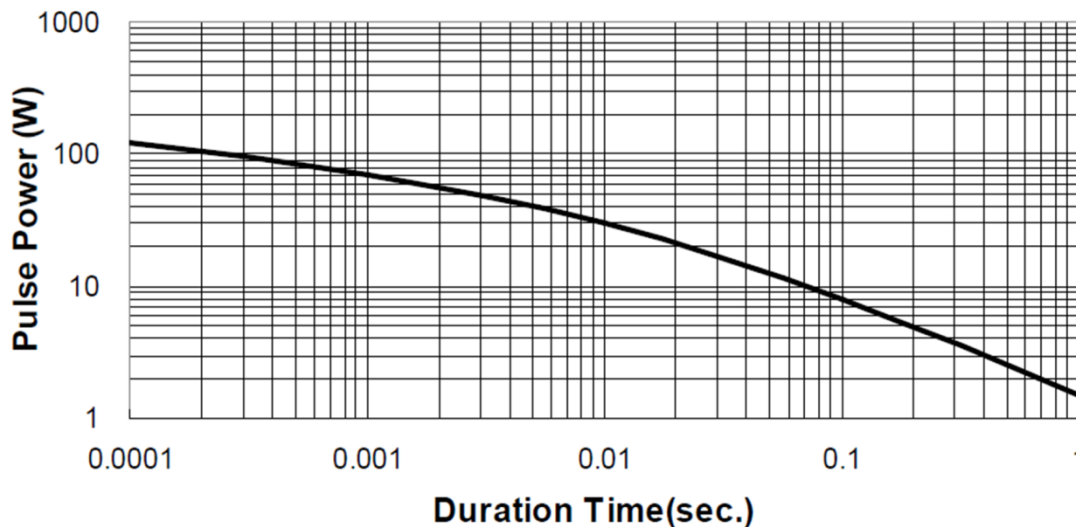

MLFA13 Pulse Voltage (100 Ohm)

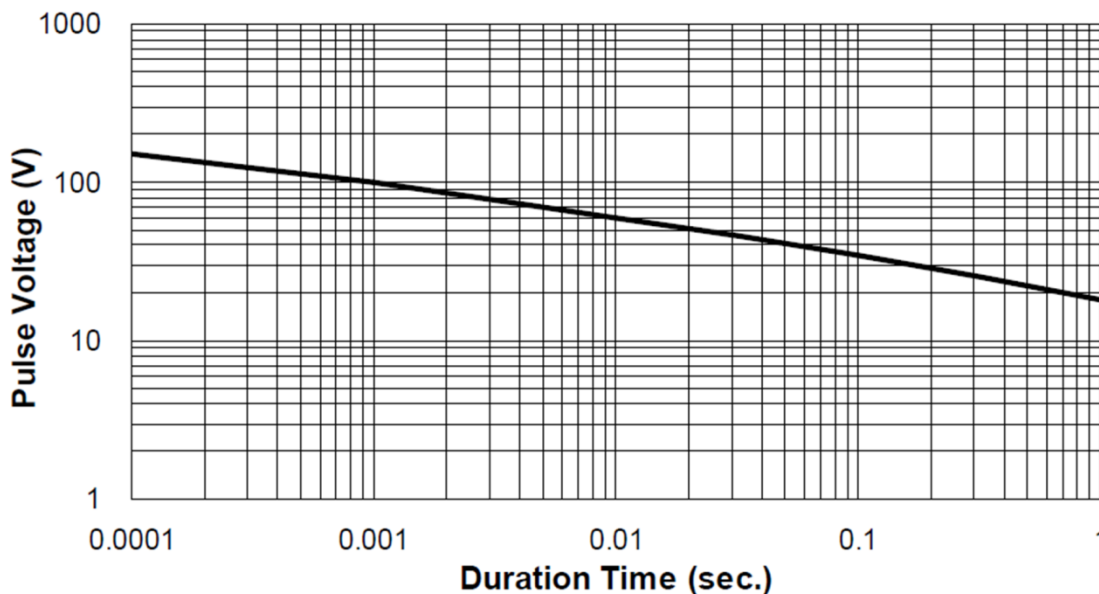

MLFA25/MLFA1 Continuous Pulse (100 Ohm)

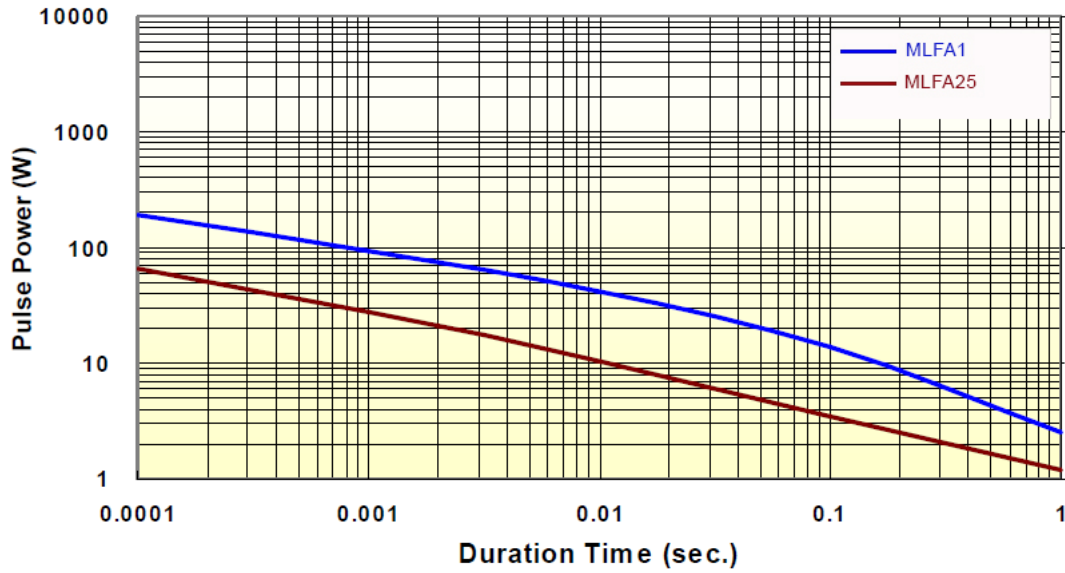

MLFA25/MLFA1 Pulse Voltage (100 Ohm)

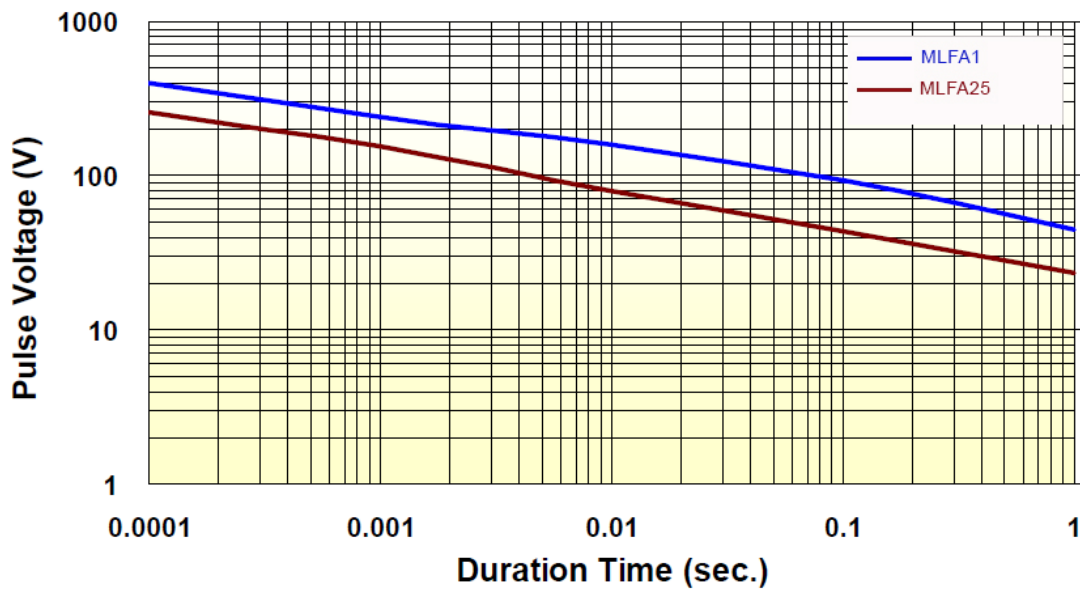

Frequency Behavior

Resistors are designed to function according to Ohmic laws. This is basically true of resistors for frequencies up to 100 kHz. At higher frequencies, there is an additional contribution to the impedance by an ideal resistor switched in series with a coil and both switched parallel to a capacitor. The values of the capacitance and inductance are mainly determined by the dimensions of the terminations and the conductive path length. The environment surrounding components has a large influence on the behavior of the component on the printed-circuit board.

MLFA25 Frequency versus Impedance

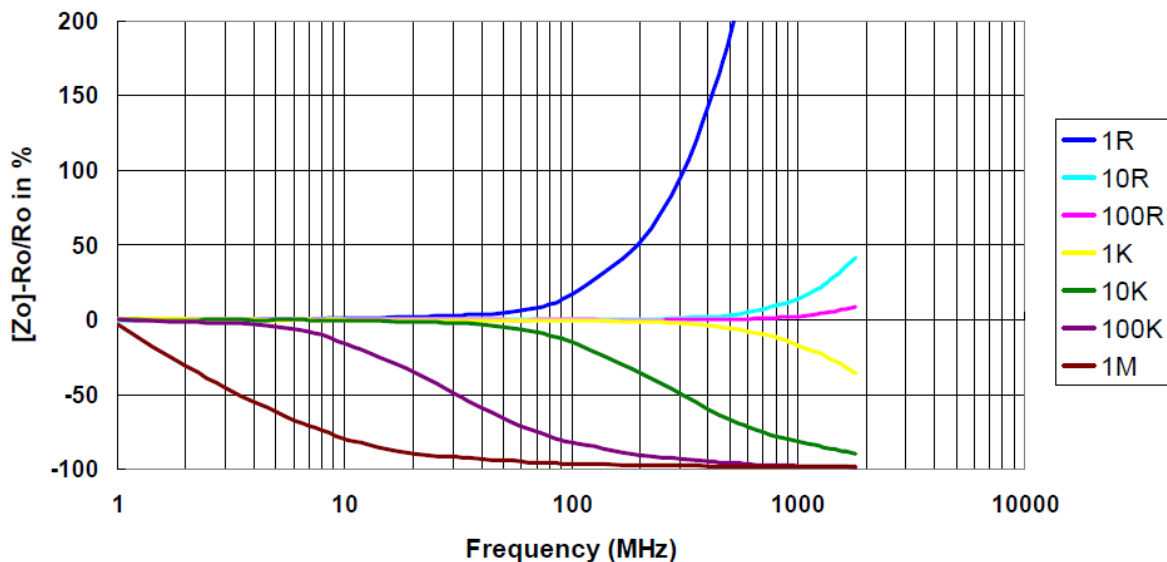

MLFA25 Frequency versus Phase Angle

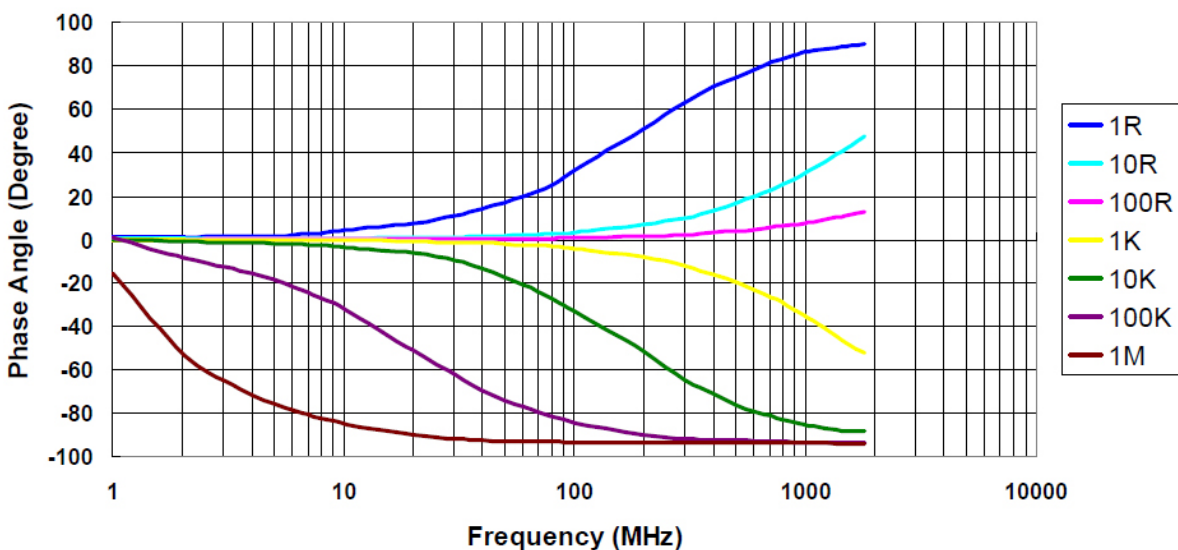

MLFA1 Frequency versus Impedance

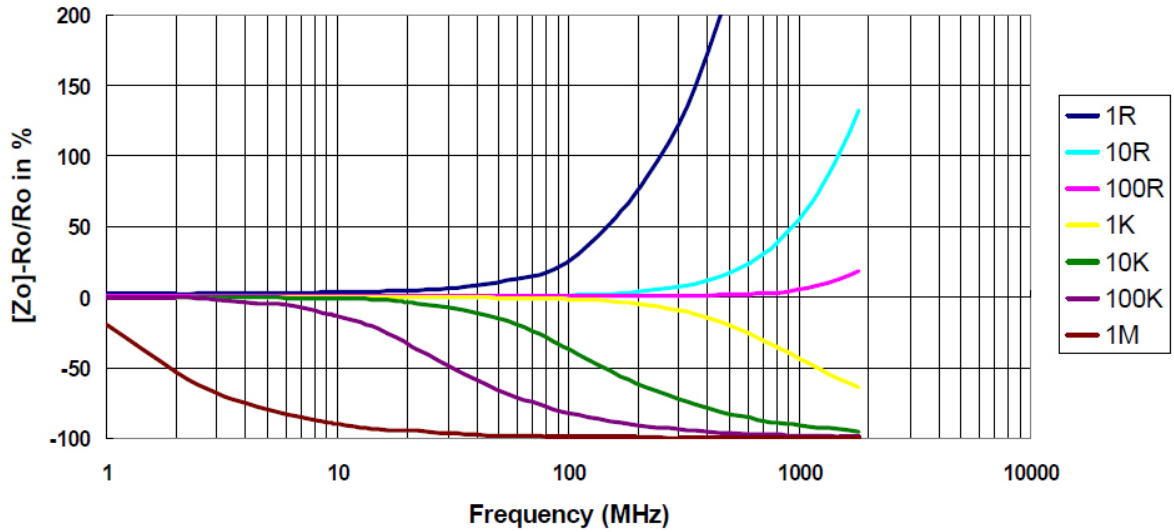

MLFA1 Frequency versus Phase Angle

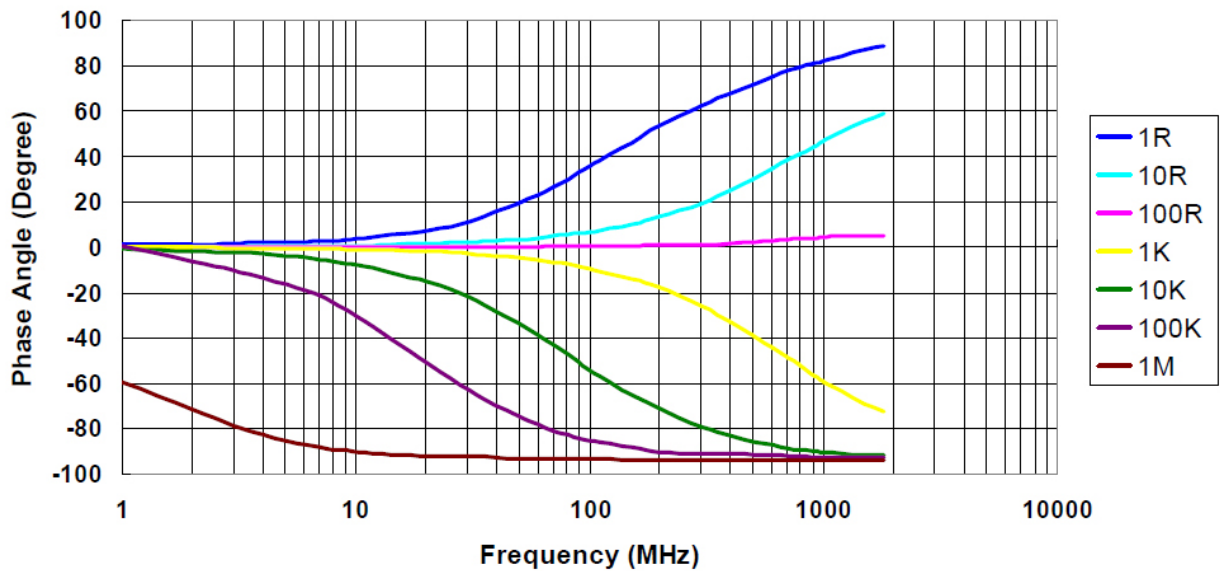

Lightning Surge

Resistors are tested in accordance with IEC 60 115-1 using both 1.2/50µs and 10/700µs pulse shapes. The limit of acceptance is a shift in resistance of less than 0.5% from the initial value.

MLFA13 1.2/50µs Lightning Surge

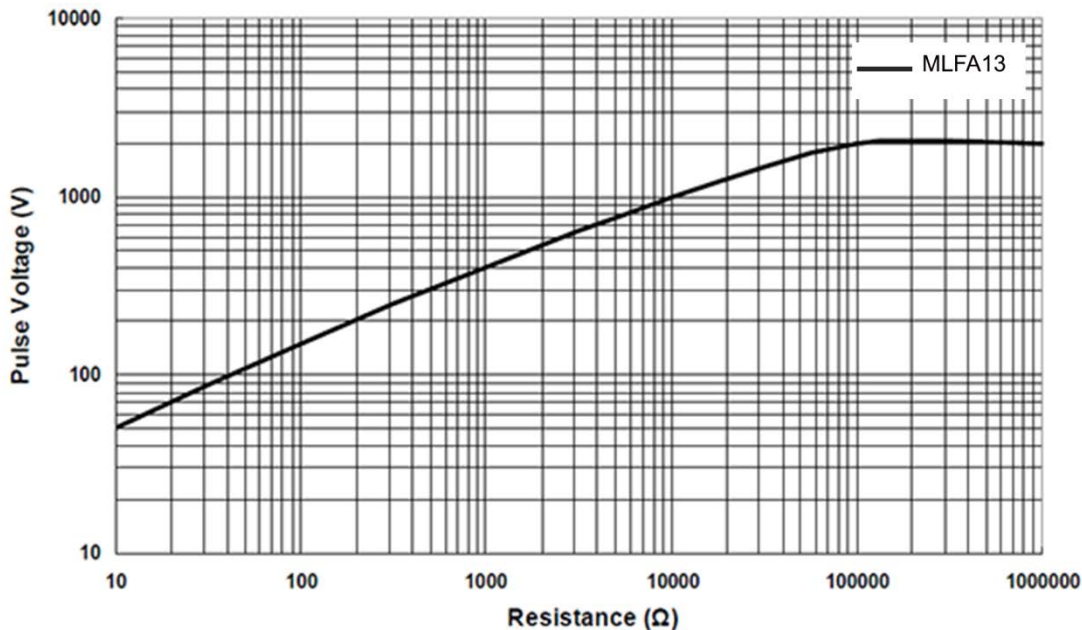

MLFA13 10/700µs Lightning Surge

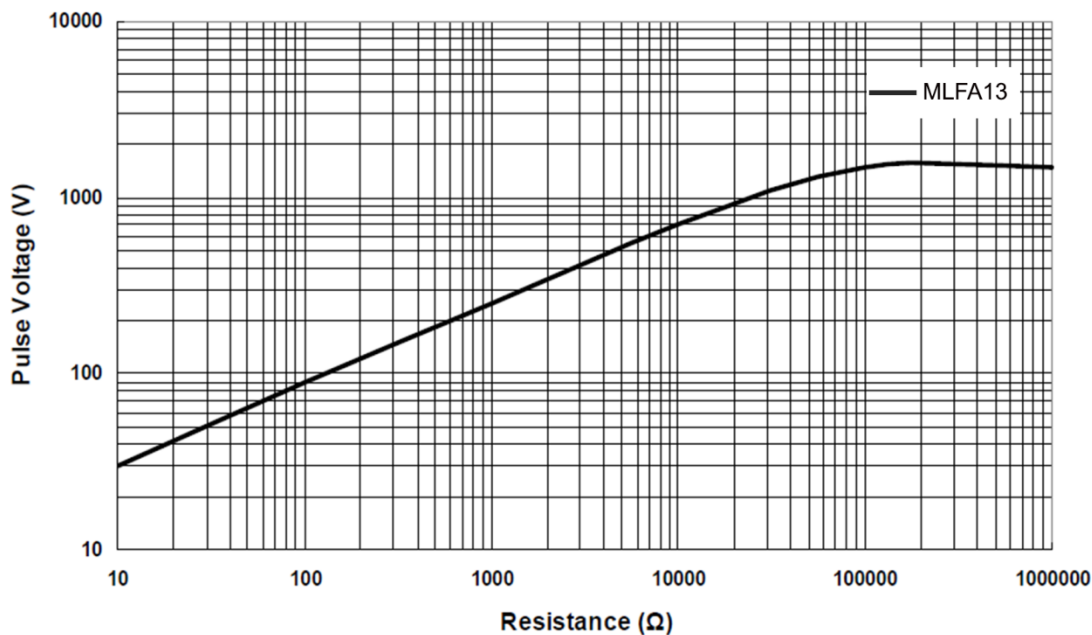

MLFA25/MLFA1 1.2/50µs Lightning Surge

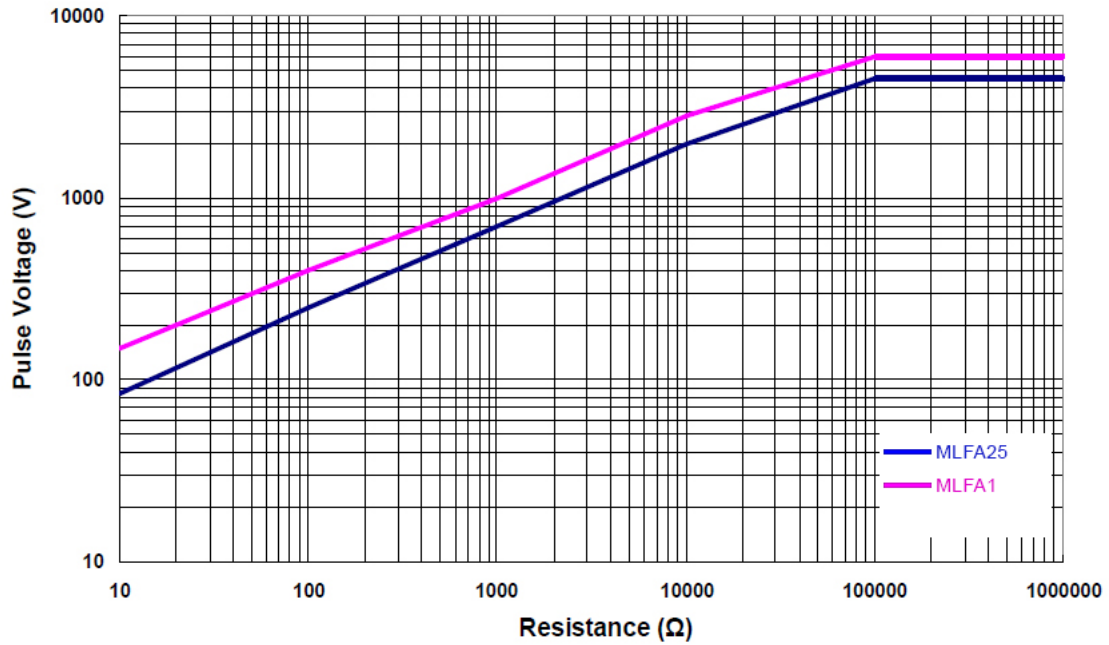

10/700µs Lightning Surge

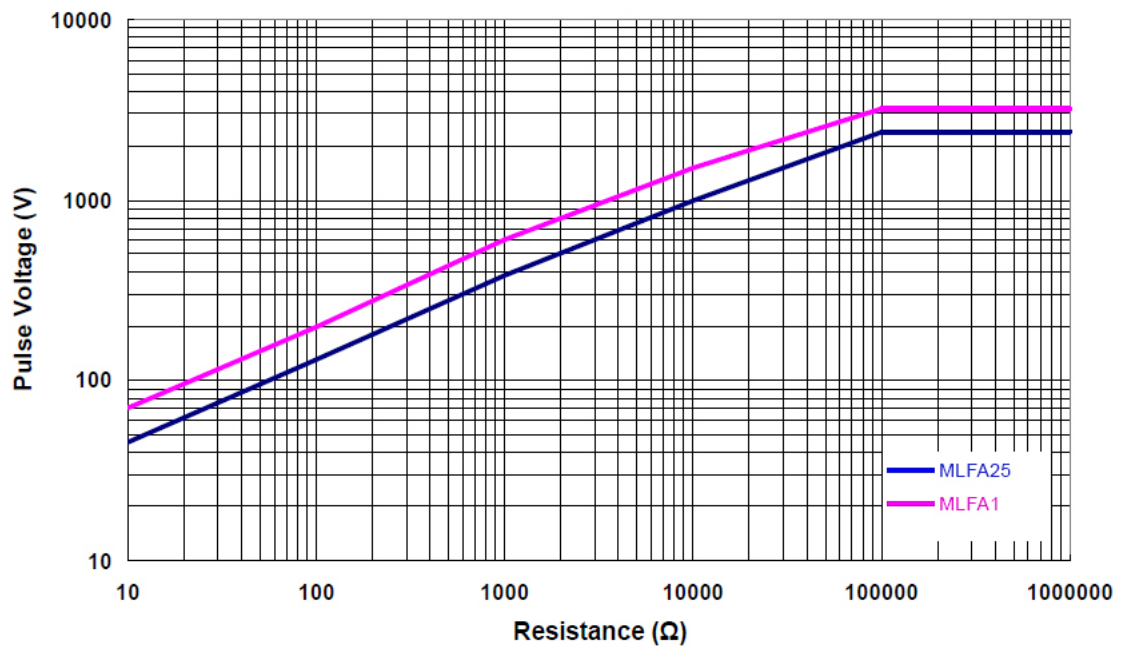

RoHS Compliance

Stackpole Electronics has joined the worldwide effort to reduce the amount of lead in electronic components and to meet the various regulatory requirements now prevalent, such as the European Union’s directive regarding “Restrictions on Hazardous Substances” (RoHS 3). As part of this ongoing program, we periodically update this document with the status regarding the availability of our compliant components. All our standard part numbers are compliant to EU Directive 2011/65/EU of the European Parliament as amended by Directive (EU) 2015/863/EU as regards the list of restricted substances.

RoHS Compliance Status						
Standard Product Series	Description	Package / Termination Type	Standard Series RoHS Compliant	Lead-Free Termination Composition	Lead-Free Mfg. Effective Date (Std Product Series)	Lead-Free Effective Date Code (YY/WW)
MLFA	Metal Film Melf Resistor (AEC-Q200 Qualified)	SMD	YES	100% Matte Sn	Always	Always

Conflict Metals” Commitment

We at Stackpole Electronics, Inc. are joined with our industry in opposing the use of metals mined in the “conflict region” of the eastern Democratic Republic of the Congo (DRC) in our products. Recognizing that the supply chain for metals used in the electronics industry is very complex, we work closely with our own suppliers to verify to the extent possible that the materials and products we supply do not contain metals sourced from this conflict region. As such, we are in compliance with the requirements of Dodd-Frank Act regarding Conflict Minerals.

Compliance to “REACH”

We certify that all passive components supplied by Stackpole Electronics, Inc. are SVHC (Substances of Very High Concern) free and compliant with the requirements of EU Directive 1907/2006/EC, “The Registration, Evaluation, Authorization and Restriction of Chemicals”, otherwise referred to as REACH. Contact us for complete list of REACH Substance Candidate List.

Environmental Policy

It is the policy of Stackpole Electronics, Inc. (SEI) to protect the environment in all localities in which we operate. We continually strive to improve our effect on the environment. We observe all applicable laws and regulations regarding the protection of our environment and all requests related to the environment to which we have agreed. We are committed to the prevention of all forms of pollution.

How to Order

	1	2	3	4	5	6	7	8	10	11	12	13	14
	M	L	F	A	2	5	F	T	S	1	0	0	K

Product Series	Power Rating			Tolerance			Packaging				TCR		Resistance Value
MLFA	Code	Size	Power	Code	Tol	Value	Code	Description	Product Code	Quantity	Code	ppm	Four characters with the multiplier used as the decimal holder. 1 ohm = 1R00 100 Kohm = 100K 1 Mohm = 1M00 zero ohm jumper = 0R00
	13	0102	0.3W	B	0.1%	E96, E24	T	7" Reel Plastic Tape	MLFA13	3,000	Z	jumper	
	25	0204	0.4W	D	0.5%		S		15		MLFA25		
	1	0207	1W	F	1%	E24	E		25		MLFA1	C	
				J	5%		D	100					
				Z	Jumper								