

## QBVE067A0B Barracuda\*; DC-DC Converter Power Modules

40-60Vdc Input; 12.0Vdc, 67.0A, 800W Output

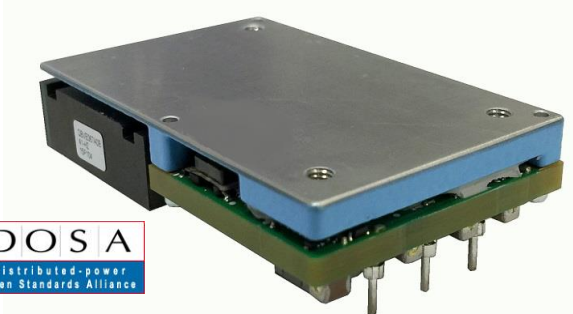

### RoHS Compliant

### Applications

- Distributed power architectures
- Intermediate bus voltage applications
- Networking equipment including Power over Ethernet (PoE)
- Servers and storage applications
- Supercomputers
- Automatic Test Equipment

### Options

- Passive Droop Load Sharing (-P=option code)
- Negative Remote On/Off logic (1=option code, factory preferred)
- Auto-restart after fault shutdown (4=option code, factory preferred)
- Pin trim

### Description

The QBVE067A0B Barracuda series of dc-dc converters are a new generation of fully regulated DC/DC power modules designed to support 12.0Vdc intermediate bus applications where multiple low voltages are subsequently generated using point of load (POL) converters, as well as other application requiring a tightly regulated output voltage. The QBVE067A0B series operate from an input voltage range of 40 to 60Vdc and provide up to 800W output power with a fully regulated output voltage of 12.0Vdc in an industry standard, DOSA compliant quarter brick. The converter incorporates digital control, synchronous rectification technology, a fully regulated control topology, and innovative packaging techniques to achieve efficiency exceeding 96.3% at 12.0Vdc output. This leads to lower power dissipations such that for many applications a heat sink is not required. Standard features include a heat plate to attach external heat sinks or contact a cold wall, on/off control, output overcurrent and over voltage protection, over temperature protection, input under and over voltage lockout.

The output is fully isolated from the input, allowing versatile polarity configurations and grounding connections. Built-in filtering for both input and output minimizes the need for external filtering.

\* Trademark of General Electric Company

# UL is a registered trademark of Underwriters Laboratories, Inc.

† CSA is a registered trademark of Canadian Standards Association.

‡ VDE is a trademark of Verband Deutscher Elektrotechniker e.V.

⌘ IEEE and 802 are registered trademarks of the Institute of Electrical and Electronics Engineers, Incorporated.

§ This product is intended for integration into end-user equipment. All of the required procedures of end-use equipment should be followed.

\*\* ISO is a registered trademark of the International Organization of Standards.

### Features

- Compliant to RoHS Directive 2011/65/EU and amended Directive (EU) 2015/863
- Compliant to REACH Directive (EC) No 1907/2006
- Can be processed with paste-through-hole Pb or Pb-free reflow process
- High and flat efficiency > 96.3% 50-90% load at  $V_{in}=50V_{dc}$
- Input voltage range: 40-60V<sub>dc</sub>
- Delivers up to 800W output power
- Fully regulated 12V output voltage at  $V_{in}$  minimum
- Low output ripple and noise
- Industry standard, DOSA Compliant Quarter Brick: 58.4mm x 36.8mm x 12.7mm (2.30in x 1.45in x 0.50in)
- Constant switching frequency
- Remote On/Off control
- Output over current/voltage protection
- Over temperature protection
- Wide operating temperature range: -40°C to 85°C, continuous
- ANSI/UL# 62368-1 and CAN/CSA† C22.2 No. 62368-1 Recognized, DIN VDE‡ 0868-1/A11:2017 (EN62368-1:2014/A11:2017)
- Meets the voltage and current requirements for ETSI 300-132-2 and complies with and licensed for Basic insulation rating
- 2250V<sub>dc</sub> Isolation tested in compliance with IEEE 802.3<sup>⌘</sup> PoE standards
- CE mark meets 2014/35/EU directive<sup>§</sup>
- ISO\*\* 9001 and ISO14001 certified manufacturing facilities
- Base plate (-H=option code, always required)

## QBVE067A0B Barracuda; DC-DC Converter Power Modules

### 40-60Vdc Input; 12.0Vdc, 67.0A, 800W Output

#### Absolute Maximum Ratings

Stresses in excess of the absolute maximum ratings can cause permanent damage to the device. These are absolute stress ratings only, functional operation of the device is not implied at these or any other conditions in excess of those given in the operations sections of the Data Sheet. Exposure to absolute maximum ratings for extended periods can adversely affect device reliability.

Parameter	Symbol	Min	Max	Unit
Input Voltage <sup>1</sup>	$V_{IN}$	-0.3	60	V <sub>dc</sub>
Continuous	$V_{IN}$		60	V <sub>dc</sub>
Non- operating continuous	$V_{IN}$		64	V <sub>dc</sub>
Operating Ambient Temperature	$T_A$	-40	85	°C
Storage Temperature	$T_{stg}$	-40	125	°C
I/O Isolation Voltage <sup>2</sup> (100% factory Hi-Pot tested)	—	—	2250	V <sub>dc</sub>

<sup>1</sup> Input over voltage protection will shutdown the output voltage when the input voltage exceeds threshold level.

<sup>2</sup> Base plate is considered floating.

#### Electrical Specifications

Unless otherwise indicated, specifications apply over all operating input voltage, resistive load, and temperature conditions.

Parameter	Device	Symbol	Min	Typ	Max	Unit
Operating Input Voltage		$V_{IN}$	40	48/52/54	60	V <sub>dc</sub>
Maximum Input Current ( $V_{IN}=40V$ , $I_o=I_{o,max}$ )		$I_{IN,max}$	—	—	22	A <sub>dc</sub>
Input No Load Current ( $V_{IN} = V_{IN,nom}$ , $I_o = 0$ , module enabled)	All	$I_{IN,No load}$		195		mA
Input Stand-by Current ( $V_{IN} = V_{IN,nom}$ , module disabled)	All	$I_{IN,stand-by}$			30	mA
External Input Capacitance	All		140	—	—	μF
Inrush Transient	All	$I^2t$	—	—	1	A <sup>2</sup> s
Input Terminal Ripple Current (Measured at module input pin with maximum specified input capacitance and < 500uH inductance between voltage source and input capacitance) 5Hz to 20MHz, $V_{IN}= 48V$ , $I_o= I_{Omax}$	All		—	—	900	mA <sub>rms</sub>
Input Ripple Rejection (120Hz)	All		—	25	—	dB

**CAUTION: This power module is not internally fused. An input line fuse must always be used.**

This power module can be used in a wide variety of applications, ranging from simple standalone operation to an integrated part of sophisticated power architecture. To preserve maximum flexibility, internal fusing is not included, however, to achieve maximum safety and system protection, always use an input line fuse. The safety agencies require a fast-acting fuse with a maximum rating of 30A in the ungrounded input lead of the power supply (see Safety Considerations section). Based on the information provided in this Data Sheet on inrush energy and maximum dc input current, the same type of fuse with a lower rating can be used. Refer to the fuse manufacturer's Data Sheet for further information.

# QBVE067A0B Barracuda; DC-DC Converter Power Modules

## 40-60Vdc Input; 12.0Vdc, 67.0A, 800W Output

### Electrical Specifications

Unless otherwise indicated, specifications apply over all operating input voltage, resistive load, and temperature conditions.

Parameter	Device	Symbol	Min	Typ	Max	Unit
Output Voltage Set-point ( $V_{IN}=48V$ , $I_o=33.5A$ , $T_A=25^\circ C$ )	All	$V_{O,set}$	11.95	12.00	12.05	V <sub>dc</sub>
Output Voltage (Over all operating input voltage (40V to 60V), resistive load, and temperature conditions until end of life)	All w/o -P	$V_o$	11.64	—	12.36	V <sub>dc</sub>
Output Voltage (Over all operating input voltage (40V to 60V), resistive load, and temperature conditions until end of life)	-P Option	$V_o$	11.50	—	12.50	V <sub>dc</sub>
Output Regulation [ $V_{IN,min} = 40V$ ]						
Line ( $V_{IN}=V_{IN,min}$ to $V_{IN,max}$ )	All w/o -P		—	0.2	—	% $V_{O,set}$
Line ( $V_{IN}=V_{IN,min}$ to $V_{IN,max}$ )	-P Option		—	0.5	—	% $V_{O,set}$
Load ( $I_o=I_{o,min}$ to $I_{o,max}$ )	All w/o -P		—	0.2	—	% $V_{O,set}$
Load ( $I_o=I_{o,min}$ to $I_{o,max}$ ), Intentional Droop	-P Option		—	0.30	—	V <sub>dc</sub>
Temperature ( $T_A = -40^\circ C$ to $+85^\circ C$ )	All		—	2	—	% $V_{O,set}$
Output Ripple and Noise, $C_o=750\mu F$ , ½ Ceramic, ½ PosCap ( $V_{IN}=V_{IN,nom}$ and $I_o=I_{o,min}$ to $I_{o,max}$ )						
RMS (5Hz to 20MHz bandwidth)	All		—	70	—	mV <sub>rms</sub>
Peak-to-Peak (5Hz to 20MHz bandwidth)	All		—	—	150	mV <sub>pk-pk</sub>
External Output Capacitance (Startup $I_{o}\leq 55A$ ; mix<20% ceramic, remainder electrolytic types)	All	$C_{o,max}$	0	—	8,000	µF
Output Current	All	$I_o$	0	—	67	A
Output Power	All	$P_o$	0	—	800	W
Output Current Limit Inception	All	$I_{o,lim}$	74	—	89	A <sub>dc</sub>
Efficiency ( $V_{IN} = 48V$ $T_A = 25^\circ C$ )						
$I_o=100\% I_{o,max}$ , $V_o=V_{o,set}$	All	$\eta$		96.1		%
$I_o=50\% I_{o,max}$ to $90\% I_{o,max}$ , $V_o=V_{o,set}$	All	$\eta$		96.3		%
Switching Frequency (Primary FETs)	All	fsw		170		kHz
Dynamic Load Response $di_o/dt=1A/\mu s$ ; $V_{in}=V_{in,nom}$ ; $T_A=25^\circ C$ ; (Tested with a 1.0µF ceramic, and 470µF capacitor at the load.)						
Load Change from $I_o = 50\%$ to $75\%$ of $I_{o,max}$ :						
Peak Deviation	All	$V_{pk}$	—	450	—	mV <sub>pk</sub>
Settling Time ( $V_o < 10\%$ peak deviation)	All	$t_s$	—	300	—	µs
Load Change from $I_o = 75\%$ to $50\%$ of $I_{o,max}$ :						
Peak Deviation	All	$V_{pk}$	—	450	—	mV <sub>pk</sub>
Settling Time ( $V_o < 10\%$ peak deviation)	All	$t_s$	—	300	—	µs

### Isolation Specifications

Parameter	Symbol	Min	Typ	Max	Unit
Isolation Capacitance	$C_{iso}$	—	4000	—	pF
Isolation Resistance	$R_{iso}$	10	—	—	MΩ

### General Specifications

Parameter	Device	Symbol	Typ	Unit
Calculated Reliability Based upon Telcordia SR-332 Issue 3: Method I, Case 3, ( $I_o=80\%I_{o,max}$ , $T_c=40^\circ C$ , Airflow = 200 LFM), 90% confidence	All	MTBF	9,785,467	Hours
	All	FIT	102.2	10 <sup>9</sup> /Hours
Weight – with Base plate			71.0 (2.50)	g (oz.)

## QBVE067A0B Barracuda; DC-DC Converter Power Modules

### 40-60Vdc Input; 12.0Vdc, 67.0A, 800W Output

### Feature Specifications

Unless otherwise indicated, specifications apply over all operating input voltage, resistive load, and temperature conditions. See Feature Descriptions for additional information.

Parameter	Device	Symbol	Min	Typ	Max	Unit
Remote On/Off Signal Interface ( $V_{IN}=V_{IN, min}$ to $V_{IN, max}$ , Signal referenced to $V_{IN-}$ terminal) Negative Logic: device code suffix "1" Logic Low = module On, Logic High = module Off Positive Logic: No device code suffix required Logic Low = module Off, Logic High = module On Logic Low Specification On/Off Thresholds: Remote On/Off Current – Logic Low ( $V_{in}=56V$ ) Logic Low Voltage Logic High Voltage – (Typ = Open Collector) Logic High maximum allowable leakage current ( $V_{on/off}=2.4V$ ) Maximum voltage allowed on On/Off pin	All	$I_{on/off}$	—	—	200	$\mu A$
	All	$V_{on/off}$	-0.3	—	0.8	$V_{dc}$
	All	$V_{on/off}$	2.4	—	14.5	$V_{dc}$
	All	$I_{on/off}$	—	—	130	$\mu A$
	All	$V_{on/off}$	—	—	14.5	$V_{dc}$
Turn-On Delay and Rise Times ( $I_o=I_{o, max}$ ) $T_{delay}$ =Time until $V_o = 10\%$ of $V_{o, set}$ from either application of Vin with Remote On/Off set to On (Enable with Vin); or operation of Remote On/Off from Off to On with Vin already applied for at least 30 milli-seconds (Enable with on/off). * Increased $T_{delay}$ due to startup for parallel modules.	All w/o "P" option	$T_{delay, Enable with Vin}$	—	—	30	ms
		$T_{delay, Enable with on/off}$	—	—	5	ms
	All w/ "P" option	$T_{delay, Enable with Vin}$	—	—	TBD	ms
		$T_{delay, Enable with on/off}$	—	—	TBD	ms
$T_{rise}$ =Time for $V_o$ to rise from 10% to 90% of $V_{o, set}$	All	$T_{rise}$	—	—	15	ms
Load Sharing Current Balance (difference in output current across all modules with outputs in parallel, no load to full load)	All w/ "P" option	$I_{diff}$	—	—	6	$A_{dc}$
Output Overvoltage Protection	All	$V_{o, limit}$	13.0	—	16.0	$V_{dc}$
Overtemperature Protection (See Feature Descriptions)	All	$T_{ref}$	—	135	—	$^{\circ}C$
Input Undervoltage Lockout Turn-on Threshold Turn-off Threshold Hysteresis	All		37.5	—	40	$V_{dc}$
	All		35.5	—	37.5	$V_{dc}$
	All		2	—	—	$V_{dc}$
Input Overvoltage Lockout Turn-off Threshold Turn-on Threshold	All		—	—	66	$V_{dc}$
	All		61	—	—	$V_{dc}$

# QBVE067A0B Barracuda; DC-DC Converter Power Modules

40-60Vdc Input; 12.0Vdc, 67.0A, 800W Output

## Characteristic Curves, 12.0V<sub>dc</sub> Output

The following figures provide typical characteristics for the QBVE067A0B (12.0V, 67A) at 25°C. The figures are identical for either positive or negative Remote On/Off logic.

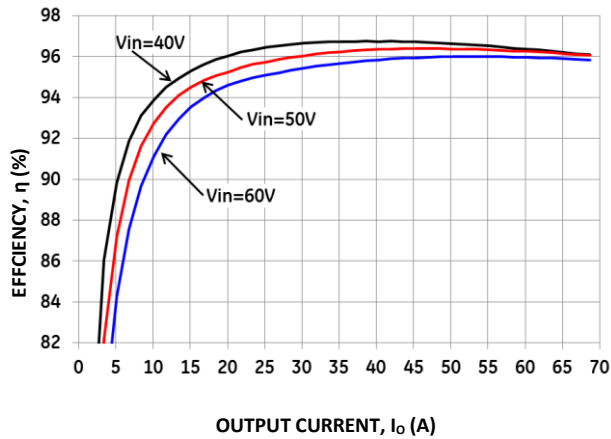

Figure 1. Typical Converter Efficiency vs. Output Current.

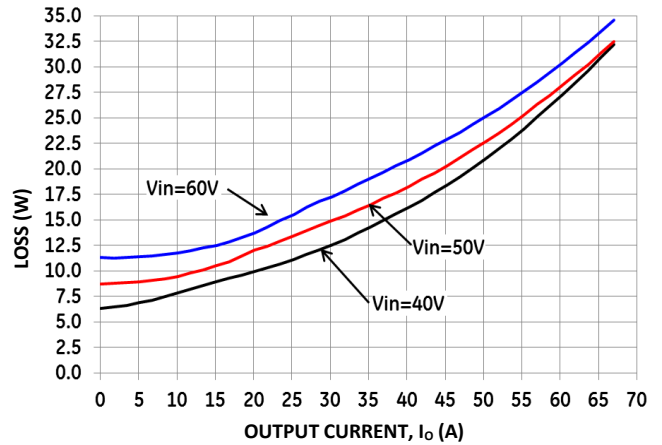

Figure 2. Typical Converter Loss vs. Output Current.

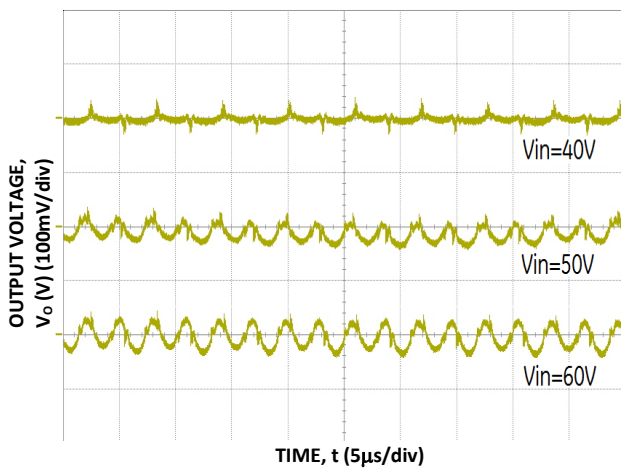

Figure 3. Typical Output Ripple and Noise,  $I_o = I_{o,max}$ ,  $C_o = 750\mu F$ .

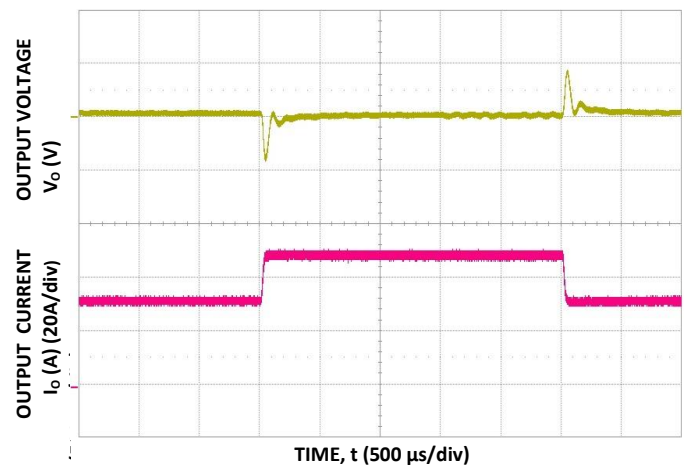

Figure 4. Typical Transient Response to 1.0A/µs Step Change in Load from 50% to 75% to 50% of Full Load,  $C_o = 470\mu F$  and 50 V<sub>dc</sub> Input.

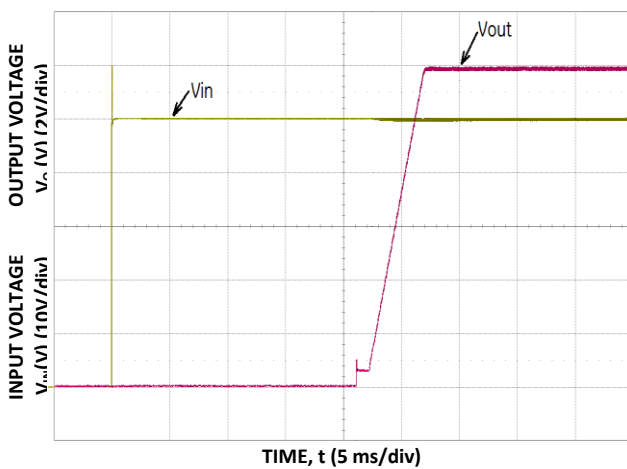

Figure 5. Typical Start-Up Using  $V_{in}$  with Remote On/Off enabled, negative logic version shown,  $I_o = I_{o,max}$ .

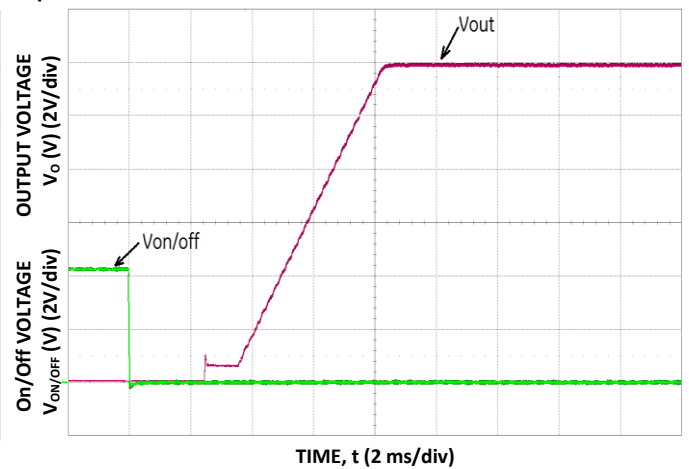

Figure 6. Typical Start-Up Using Remote On/Off with  $V_{in}$  applied, negative logic version shown  $I_o = I_{o,max}$ .

# QBVE067A0B Barracuda; DC-DC Converter Power Modules

40-60Vdc Input; 12.0Vdc, 67.0A, 800W Output

## Characteristic Curves, 12.0V<sub>dc</sub> Output (continued)

The following figures provide typical characteristics for the QBVE067A0B (12.0V, 67A) at 25°C. The figures are identical for either positive or negative Remote On/Off logic.

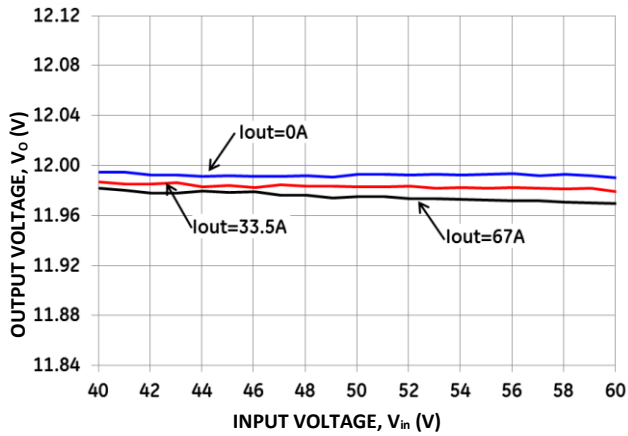

Figure 7. Typical Output Voltage Regulation vs. Input Voltage.

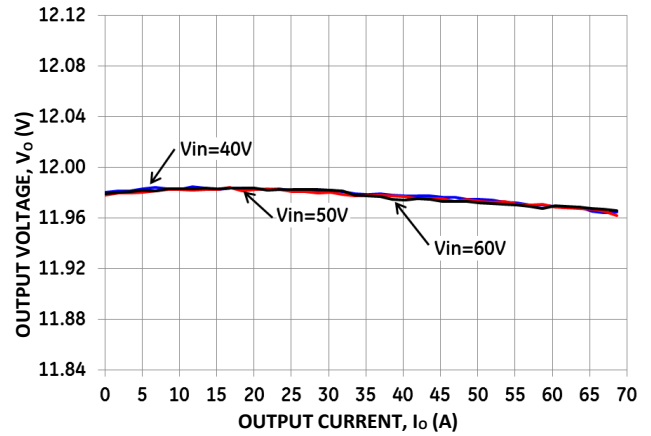

Figure 8. Typical Output Voltage Regulation vs. Output Current.

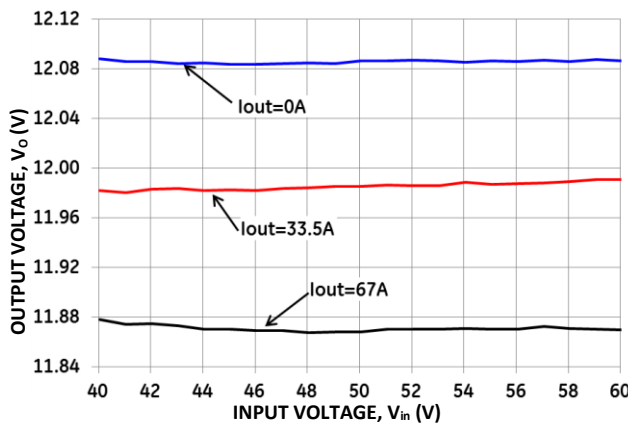

Figure 9. Typical Output Voltage Regulation vs. Input Voltage for the -P Version.

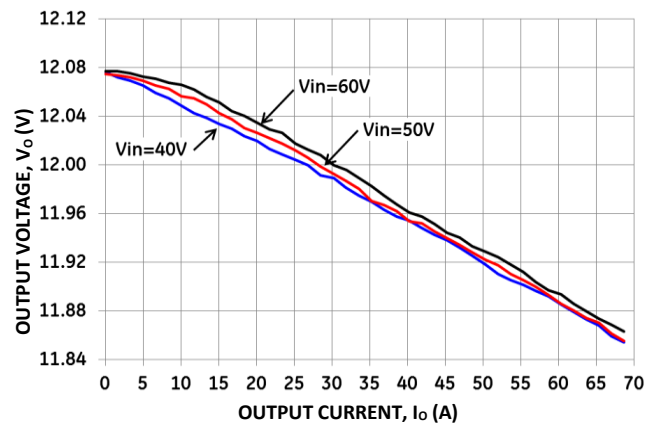

Figure 10. Typical Output Voltage Regulation vs. Output Current for the -P Version.

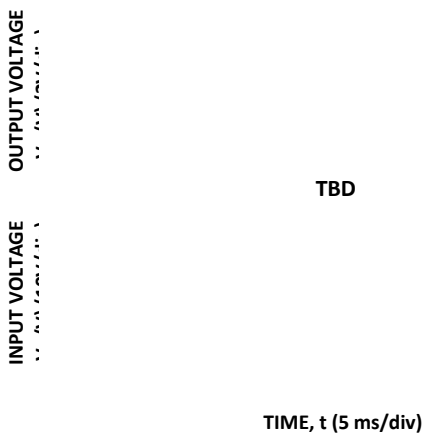

Figure 11. Typical Start-Up Using  $V_{in}$  with Remote On/Off enabled, negative logic version shown,  $I_o = I_{o,max}$  for the -P Version.

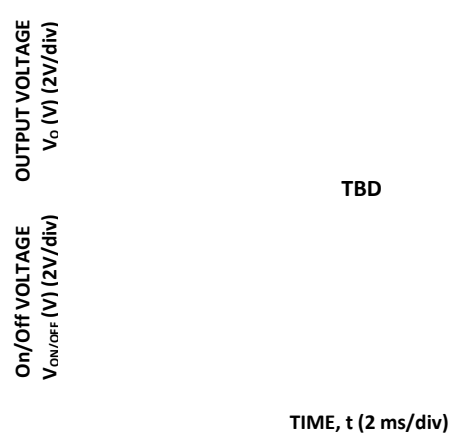
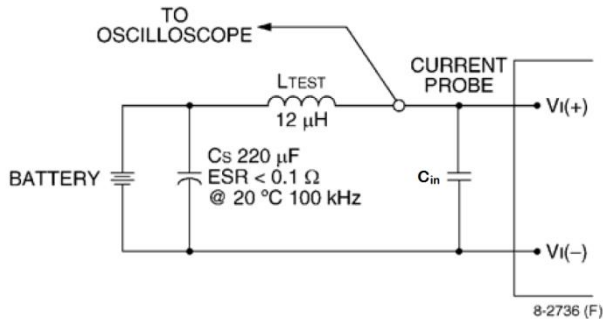

Figure 12. Typical Start-Up Using Remote On/Off with  $V_{in}$  applied, negative logic version shown  $I_o = I_{o,max}$  for the -P Version.

# QBVE067A0B Barracuda; DC-DC Converter Power Modules

40-60Vdc Input; 12.0Vdc, 67.0A, 800W Output

## Test Configurations



Note: Measure input reflected-ripple current with a simulated source inductance (LTEST) of 12 μH. Capacitor Cs offsets possible battery impedance. Measure current as shown above.

**Figure 13. Input Reflected Ripple Current Test Setup.**

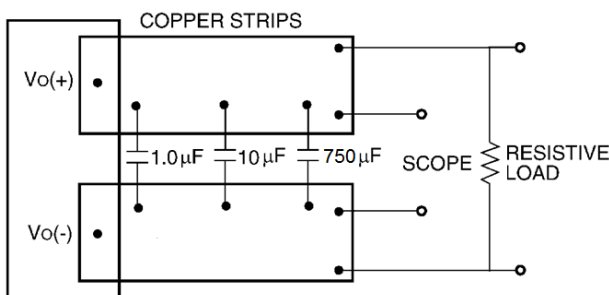

Note: Use a 1.0 μF ceramic capacitor, a 10 μF aluminum or tantalum capacitor and a 750 μF polymer capacitor. Scope measurement should be made using a BNC socket. Position the load between 51 mm and 76 mm (2 in. and 3 in.) from the module.

**Figure 14. Output Ripple and Noise Test Setup.**

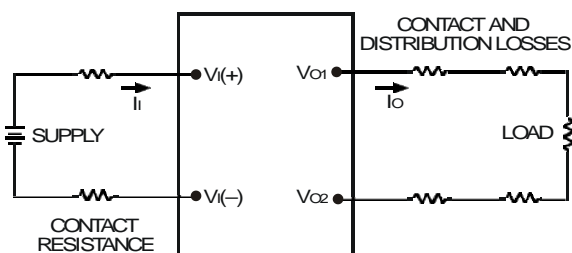

Note: All measurements are taken at the module terminals. When socketing, place Kelvin connections at module terminals to avoid measurement errors due to socket contact resistance.

$$\eta = \left( \frac{[V_{O(+)} - V_{O(-)}] I_O}{[V_{I(+)} - V_{I(-)}] I_I} \right) \times 100 \%$$

**Figure 15. Output Voltage and Efficiency Test Setup.**

## Design Considerations

### Input Source Impedance

The power module should be connected to a low ac-impedance source. Highly inductive source impedance can affect the stability of the power module. For the test configuration in Figure 11, a 660μF electrolytic capacitor, C<sub>in</sub>, (ESR<0.7Ω at 100kHz), mounted close to the power module helps ensure the stability of the unit.

### Safety Considerations

For safety-agency approval of the system in which the power module is used, the power module must be installed in compliance with the spacing and separation requirements of the end-use safety agency standard, i.e., UL ANSI/UL\* 62368-1 and CAN/CSA+ C22.2 No. 62368-1 Recognized, DIN VDE 0868-1/A11:2017 (EN62368-1:2014/A11:2017).

If the input source is non-SELV (ELV or a hazardous voltage greater than 60 Vdc and less than or equal to 75Vdc), for the module's output to be considered as meeting the requirements for safety extra-low voltage (SELV) or ES1, all of the following must be true:

- The input source is to be provided with reinforced insulation from any other hazardous voltages, including the ac mains.
- One V<sub>IN</sub> pin and one V<sub>OUT</sub> pin are to be grounded, or both the input and output pins are to be kept floating.
- The input pins of the module are not operator accessible.
- Another SELV or ES1 reliability test is conducted on the whole system (combination of supply source and subject module), as required by the safety agencies, to verify that under a single fault, hazardous voltages do not appear at the module's output.

**Note:** Do not ground either of the input pins of the module without grounding one of the output pins. This may allow a non-SELV/ES1 voltage to appear between the output pins and ground.

The power module has safety extra-low voltage (SELV) or ES1 outputs when all inputs are SELV or ES1.

For input voltages exceeding 60 Vdc but less than or equal to 75 Vdc, these converters have been evaluated to the applicable requirements of BASIC INSULATION between secondary DC MAINS DISTRIBUTION input (classified as TNV-2 in Europe) and unearthed SELV outputs.

The input to these units is to be provided with a maximum 30A fast-acting (or time-delay) fuse in the ungrounded input lead.

## QBVE067A0B Barracuda; DC-DC Converter Power Modules

40-60Vdc Input; 12.0Vdc, 67.0A, 800W Output

### Feature Descriptions

#### Overcurrent Protection

To provide protection in a fault output overload condition, the module is equipped with internal current-limiting circuitry and can endure current limiting continuously. If the overcurrent condition causes the output voltage to fall greater than 3.0V from  $V_{o,sett}$ , the module will shut down and remain latched off. The overcurrent latch is reset by either cycling the input power or by toggling the on/off pin for one second. If the output overload condition still exists when the module restarts, it will shut down again. This operation will continue indefinitely until the overcurrent condition is corrected.

A factory configured auto-restart option (with overcurrent and overvoltage auto-restart managed as a group) is also available. An auto-restart feature continually attempts to restore the operation until fault condition is cleared.

#### Remote On/Off

The module contains a standard on/off control circuit reference to the  $V_{IN(-)}$  terminal. Two factory configured remote on/off logic options are available. Positive logic remote on/off turns the module on during a logic-high voltage on the ON/OFF pin, and off during a logic low. Negative logic remote on/off turns the module off during a logic high, and on during a logic low. Negative logic, device code suffix "1," is the factory-preferred configuration. The On/Off circuit is powered from an internal bias supply, derived from the input voltage terminals. To turn the power module on and off, the user must supply a switch to control the voltage between the On/Off terminal and the  $V_{IN(-)}$  terminal ( $V_{on/off}$ ). The switch can be an open collector or equivalent (see Figure 14). A logic low is  $V_{on/off} = -0.3V$  to 0.8V. The typical  $I_{on/off}$  during a logic low ( $V_{in}=50V$ , On/Off Terminal=0.3V) is 147 $\mu A$ . The switch should maintain a logic-low voltage while sinking 200 $\mu A$ . During a logic high, the maximum  $V_{on/off}$  generated by the power module is 8.2V. The maximum allowable leakage current of the switch at  $V_{on/off} = 2.4V$  is 130 $\mu A$ . If using an external voltage source, the maximum voltage  $V_{on/off}$  on the pin is 14.5V with respect to the  $V_{IN(-)}$  terminal.

If not using the remote on/off feature, perform one of the following to turn the unit on:

For negative logic, short ON/OFF pin to  $V_{IN(-)}$ .

For positive logic: leave ON/OFF pin open.

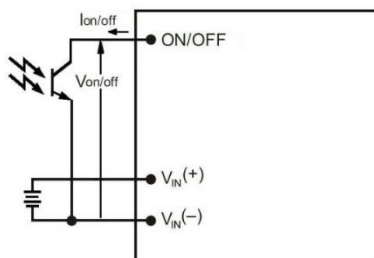

Figure 16. Remote On/Off Implementation.

#### Output Overvoltage Protection

The module contains circuitry to detect and respond to

output overvoltage conditions. If the overvoltage condition causes the output voltage to rise above the limit in the Specifications Table, the module will shut down and remain latched off. The overvoltage latch is reset by either cycling the input power, or by toggling the on/off pin for one second. If the output overvoltage condition still exists when the module restarts, it will shut down again. This operation will continue indefinitely until the overvoltage condition is corrected.

A factory configured auto-restart option (with overcurrent and overvoltage auto-restart managed as a group) is also available. An auto-restart feature continually attempts to restore the operation until fault condition is cleared.

#### Overtemperature Protection

These modules feature an overtemperature protection circuit to safeguard against thermal damage. The circuit shuts down the module when the maximum device reference temperature is exceeded. The module will automatically restart once the reference temperature cools by  $\sim 25^{\circ}C$ .

#### Input Under/Over voltage Lockout

At input voltages above or below the input under/over voltage lockout limits, module operation is disabled. The module will begin to operate when the input voltage level changes to within the under and overvoltage lockout limits.

#### Load Sharing

For higher power requirements, the QBVE067A0B-P module offers an optional feature for parallel operation (-P Option code). This feature provides a precise forced output voltage load regulation droop characteristic. The output set point and droop slope are factory calibrated to insure optimum matching of multiple modules' load regulation characteristics. To implement load sharing, the following requirements should be followed:

- The  $V_{OUT(+)}$  and  $V_{OUT(-)}$  pins of all parallel modules must be connected together. Balance the trace resistance for each module's path to the output power planes, to insure best load sharing and operating temperature balance.
- $V_{IN}$  must remain between 40V<sub>dc</sub> and 60V<sub>dc</sub> for droop sharing to be functional.
- It is permissible to use a common Remote On/Off signal to start all modules in parallel. However if spurious shutdowns occur at startup due to very low impedance between module outputs, the modules should be started sequentially instead, waiting at least the Turn-On Delay Time + Rise Time before starting the next module.
- These modules contain means to block reverse current flow upon start-up, when output voltage is present from other parallel modules, thus eliminating the requirement for external output ORing devices. Modules with the -P option may automatically increase the Turn On delay,  $T_{delay}$ , as specified in the Feature Specifications Table, if output voltage is present on the output bus at startup.
- Insure that the total load is  $< 50\% I_{O,MAX}$  (for a single module) until all parallel modules have started (load full start  $>$  module  $T_{delay}$  time max +  $T_{rise}$  time).
- If fault tolerance is desired in parallel applications, output ORing devices should be used to prevent a single module failure from collapsing the load bus.



# QBVE067A0B Barracuda; DC-DC Converter Power Modules

40-60Vdc Input; 12.0Vdc, 67.0A, 800W Output

## Feature Descriptions (continued)

### Thermal Considerations

The power modules operate in a variety of thermal environments and sufficient cooling should be provided to help ensure reliable operation. Heat-dissipating components are mounted on the top side of the module, and heat is removed by conduction, convection and radiation to the surrounding environment. Thermal considerations include ambient temperature, airflow, module power dissipation, and the need for increased reliability.

The output power of the module should not exceed the rated power for the module as listed in the Ordering Information table. Furthermore, a reduction in the operating temperature of the module will result in an increase in reliability.

Proper cooling can be verified by measuring the worst-case air temperature and speed just upstream of the module, and measuring or estimating the module output power. For reliable operation, the output power of the module should not exceed the rated power for the module or the derated power for the actual operating conditions as indicated in the derating curves of Figs. 19-24.

A simpler but less accurate way to ensure reliable operation is to measure the thermal reference temperature (TH1) at the position indicated in Figure 17. This temperature should be limited to 100°C, or a lower value for extremely high reliability. However this method limits power more than necessary for some thermal conditions; the Tref limit may be disregarded if the derating-curve method of the previous paragraph is used.

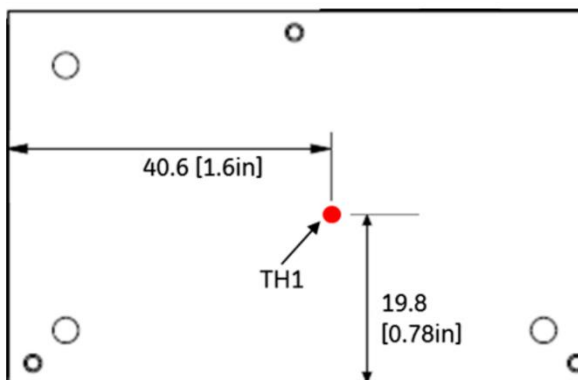

Figure 17. Location of the thermal reference temperature TH1 for base plate module.

### Heat Transfer via Convection

The thermal data presented here is based on physical measurements taken in a wind tunnel, using automated thermo-couple instrumentation to monitor key component temperatures: FETs, diodes, control ICs, magnetic cores, ceramic capacitors, opto-isolators, and module PWB conductors, while controlling the ambient airflow rate and temperature. For a given airflow and ambient temperature, the module output power is increased, until one (or more) of the components reaches its maximum derated operating temperature, as defined in IPC-9592B. This procedure is then repeated for a different airflow or ambient temperature until a family of module output derating curves is obtained. Please refer to the Application Note “Thermal Characterization Process For Open-Frame Board-Mounted Power Modules” for a detailed discussion of thermal aspects including maximum device temperatures.

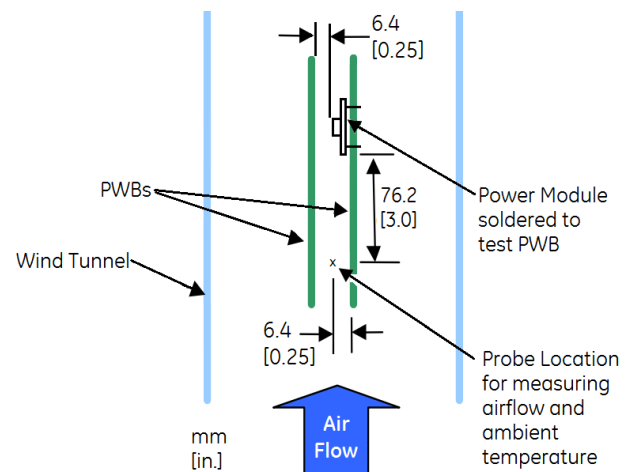

Figure 18. Thermal Test Setup .

Increased airflow over the setup enhances the heat transfer via convection. The thermal derating of figure 17- 22 shows the maximum output current that can be delivered by each module in the indicated orientation without exceeding the maximum TH1 temperature versus local ambient temperature ( $T_A$ ) for several air flow conditions.

# QBVE067A0B Barracuda; DC-DC Converter Power Modules

40-60Vdc Input; 12.0Vdc, 67.0A, 800W Output

### Thermal Considerations (continued)

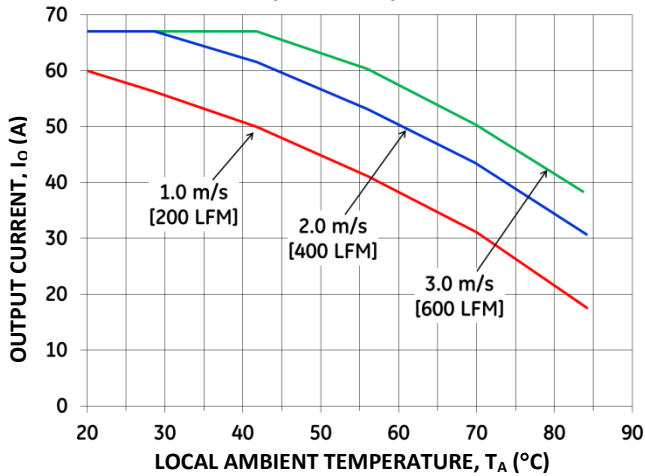

Figure 19. Output Current Derating for the Base Plate QBVE067A0Bxx-H in the Transverse Orientation; Airflow Direction from Vin(-) to Vin(+); Vin = 50V.

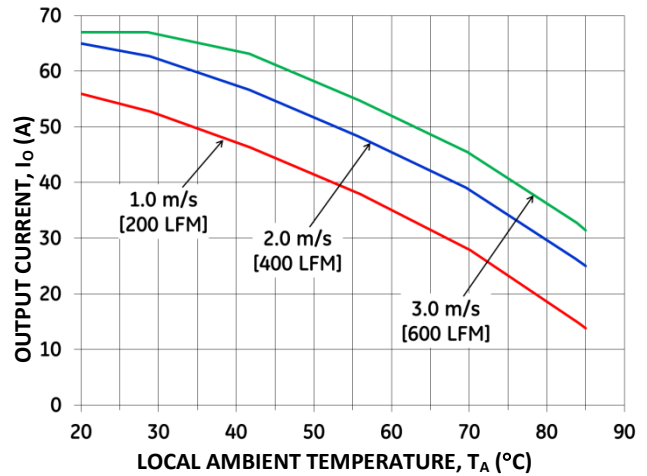

Figure 20. Output Current Derating for the Base Plate QBVE067A0Bxx-H in the Longitudinal Airflow Direction from Vout to Vin; Vin = 50V.

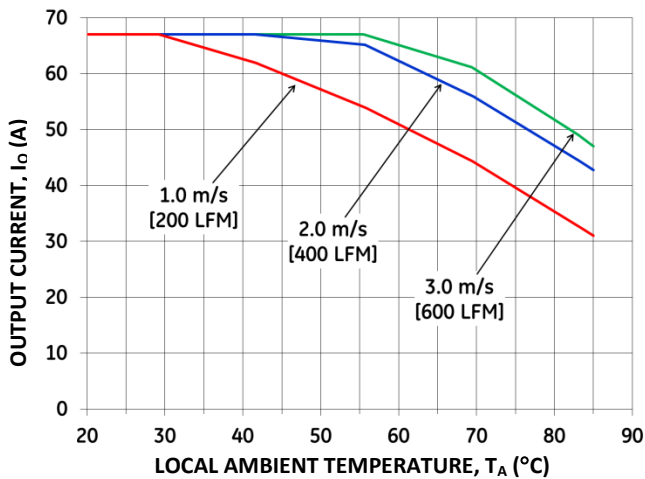

Figure 21. Output Current Derating for the Base Plate QBVE067A0Bxx-H+0.5" Heat Sink in the Transverse Orientation; Airflow Direction from Vin(-) to Vin(+); Vin = 50V.

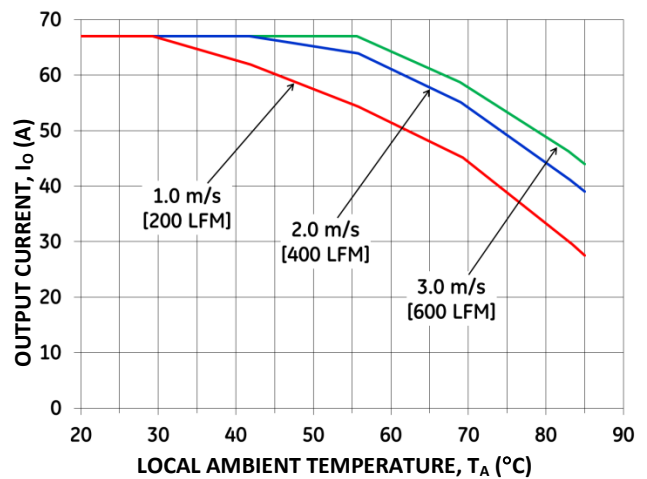

Figure 22. Output Current Derating for the Base Plate QBVE067A0Bxx-H+0.5" Heat Sink in the Longitudinal Airflow Direction from Vout to Vin; Vin = 50V.

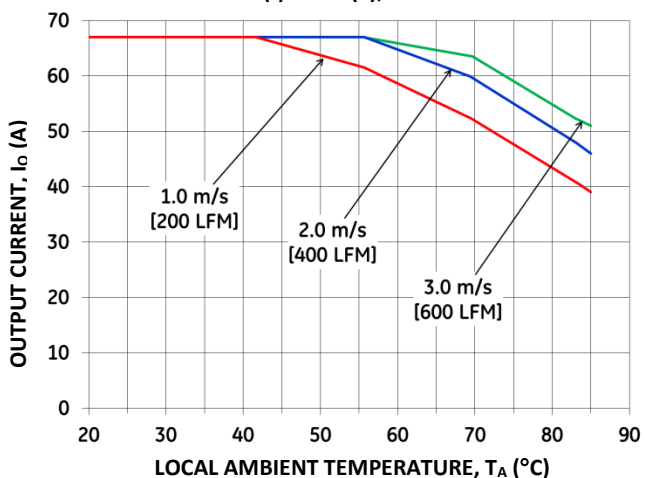

Figure 23. Output Current Derating for the Base Plate QBVE067A0Bxx-H+1.0" Heat Sink in the Transverse Orientation; Airflow Direction from Vin(-) to Vin(+); Vin = 50V.

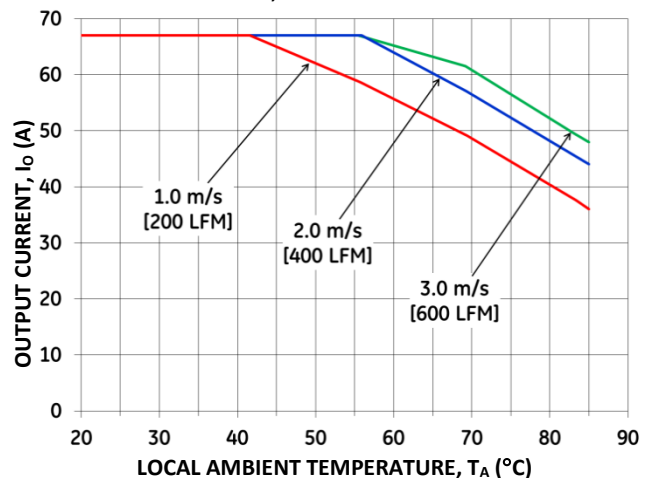

Figure 24. Output Current Derating for the Base Plate QBVE067A0Bxx-H+1.0" Heat Sink in the Longitudinal Airflow Direction from Vout to Vin; Vin = 50V.

## QBVE067A0B Barracuda; DC-DC Converter Power Modules

40-60Vdc Input; 12.0Vdc, 67.0A, 800W Output

### Layout Considerations

The QBVE067A0B power module series are low profile in order to be used in fine pitch system card architectures. As such, component clearance between the bottom of the power module and the mounting board is limited. Avoid placing copper areas on the outer layer directly underneath the power module. Also avoid placing via interconnects underneath the power module.

For additional layout guide-lines, refer to FLT012A0Z Data Sheet.

### Through-Hole Lead-Free Soldering Information

The RoHS-compliant, Z version, through-hole products use the SAC (Sn/Ag/Cu) Pb-free solder and RoHS-compliant components. The module is designed to be processed through single or dual wave soldering machines. The pins have a RoHS-compliant, pure tin finish that is compatible with both Pb and Pb-free wave soldering processes. A maximum preheat rate of 3°C/s is suggested. The wave preheat process should be such that the temperature of the power module board is kept below 210°C. For Pb solder, the recommended pot temperature is 260°C, while the Pb-free solder pot is 270°C max.

### Reflow Lead-Free Soldering Information

The RoHS-compliant through-hole products can be processed with the following paste-through-hole Pb or Pb-free reflow process.

Max. sustain temperature :

245°C (J-STD-020C Table 4-2: Packaging Thickness $\geq$ 2.5mm / Volume > 2000mm<sup>3</sup>),

Peak temperature over 245°C is not suggested due to the potential reliability risk of components under continuous high-temperature.

Min. sustain duration above 217°C : 90 seconds

Min. sustain duration above 180°C : 150 seconds

Max. heat up rate: 3°C/sec

Max. cool down rate: 4°C/sec

In compliance with JEDEC J-STD-020C spec for 2 times reflow or heat exposures including rework.

#### Pb-free Reflow Profile

BMP module will comply with J-STD-020 Rev. D (Moisture/Reflow Sensitivity Classification for Nonhermetic Solid State Surface Mount Devices) for both Pb-free solder profiles and MSL classification procedures. BMP will comply with JEDEC J-STD-020C specification for 2 times reflow or heat exposures including rework. The suggested Pb-free solder paste is Sn/Ag/Cu (SAC). The recommended linear reflow profile using Sn/Ag/Cu solder is shown in Figure 23.

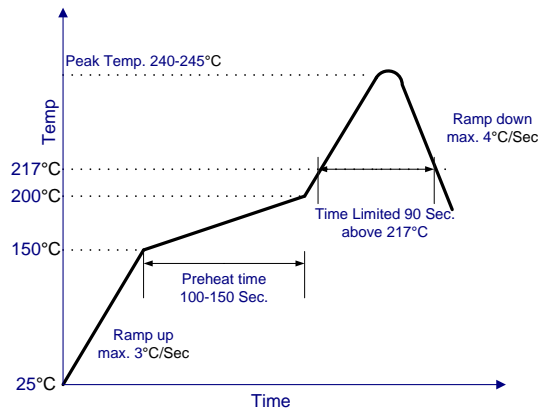

**Figure 25. Recommended linear reflow profile using Sn/Ag/Cu solder.**

### MSL Rating

The QBVE067A0B modules have a MSL rating as indicated in the Device Codes table, last page of this document.

### Storage and Handling

The recommended storage environment and handling procedures for moisture-sensitive surface mount packages is detailed in J-STD-033 Rev. A (Handling, Packing, Shipping and Use of Moisture/Reflow Sensitive Surface Mount Devices). Moisture barrier bags (MBB) with desiccant are required for MSL ratings of 2 or greater. These sealed packages should not be broken until time of use. Once the original package is broken, the floor life of the product at conditions of  $\leq$ 30°C and 60% relative humidity varies according to the MSL rating (see J-STD-060A). The shelf life for dry packed SMT packages will be a minimum of 12 months from the bag seal date, when stored at the following conditions: < 40° C, < 90% relative humidity.

### Post Solder Cleaning and Drying Considerations

Post solder cleaning is usually the final circuit board assembly process prior to electrical board testing. The result of inadequate cleaning and drying can affect both the reliability of a power module and the testability of the finished circuit board assembly. For guidance on appropriate soldering, cleaning and drying procedures, refer to GE Board Mounted Power Modules: Soldering and Cleaning Application Note (AN04-001).

If additional information is needed, please consult with your GE Sales representative for more details

# QBVE067A0B Barracuda; DC-DC Converter Power Modules

40-60Vdc Input; 12.0Vdc, 67.0A, 800W Output

## EMC Considerations

The circuit and plots in Figure 24 shows a suggested configuration to meet the conducted emission limits of

EN55032 Class A. For further information on designing for EMC compliance, please refer to the FLTR100V20Z data sheet.

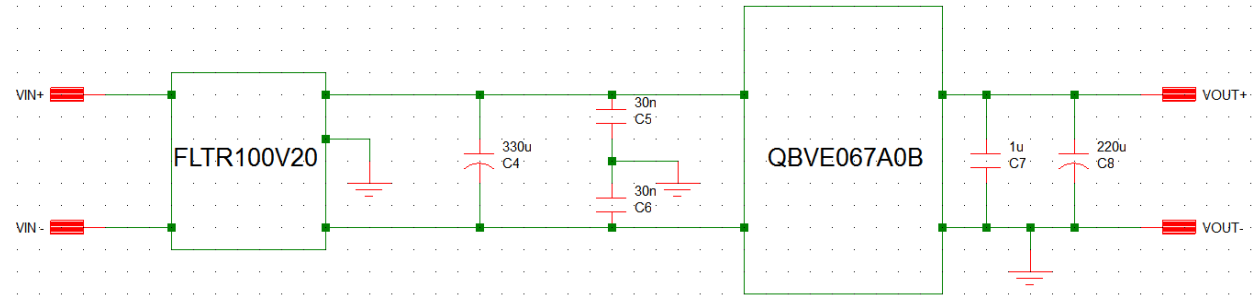

- C4 = 330uf 100V Nichicon VR series
- C5 & C6 = 3 x 0.01uf High Voltage caps
- C7= 1uf 100V 1210
- C8 = 220uf 100V KME Nichicon VR series

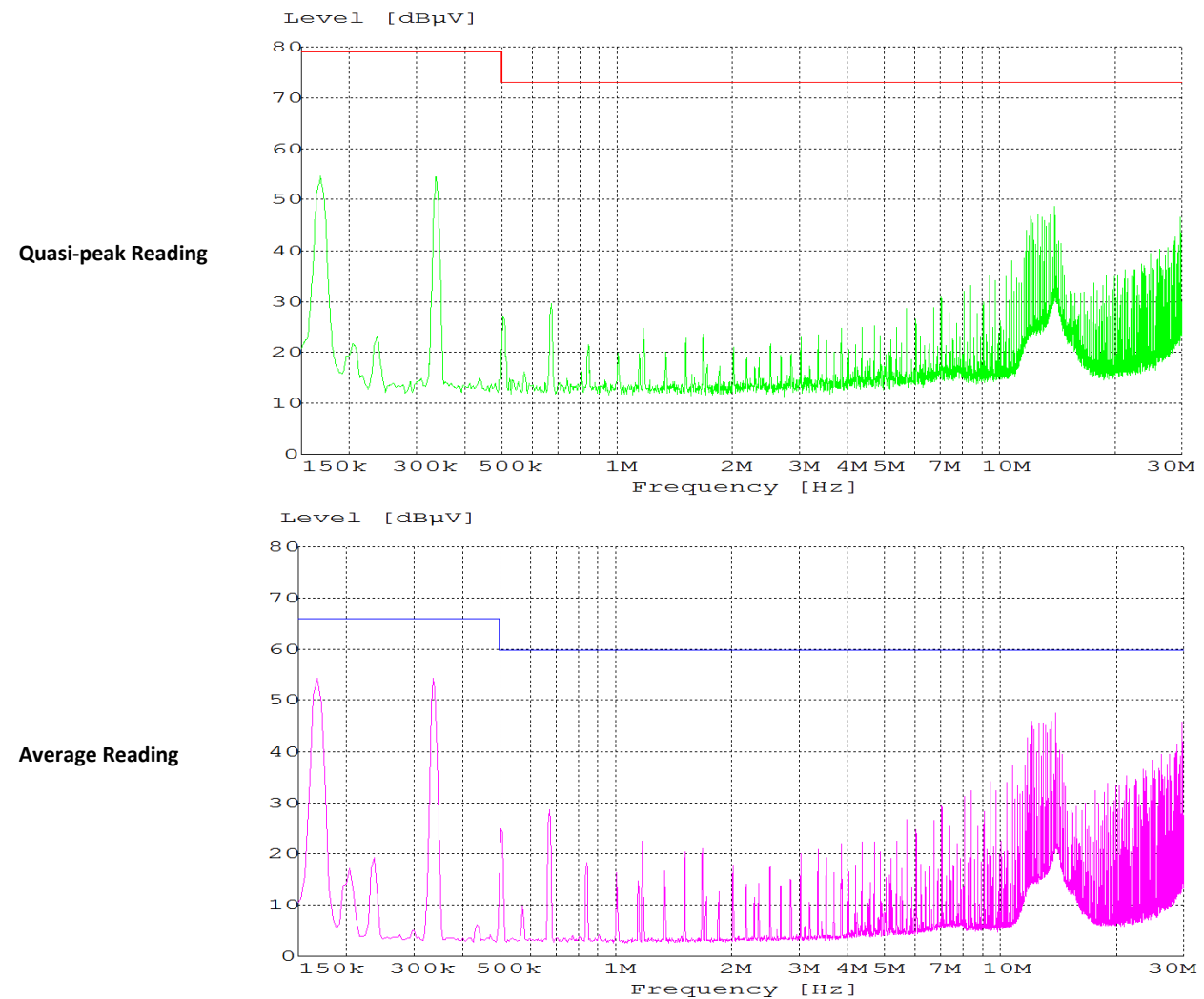

Figure 26. EMC Considerations

# QBVE067A0B Barracuda; DC-DC Converter Power Modules

40-60Vdc Input; 12.0Vdc, 67.0A, 800W Output

## Mechanical Outline for QBVE067A0B41-HZ (Base plate) Through-hole Module

Dimensions are in millimeters and [inches].

Tolerances: x.x mm ± 0.5 mm [x.xx in. ± 0.02 in.] (Unless otherwise indicated)

x.xx mm ± 0.25 mm [x.xxx in ± 0.010 in.]

TOP VIEW\*

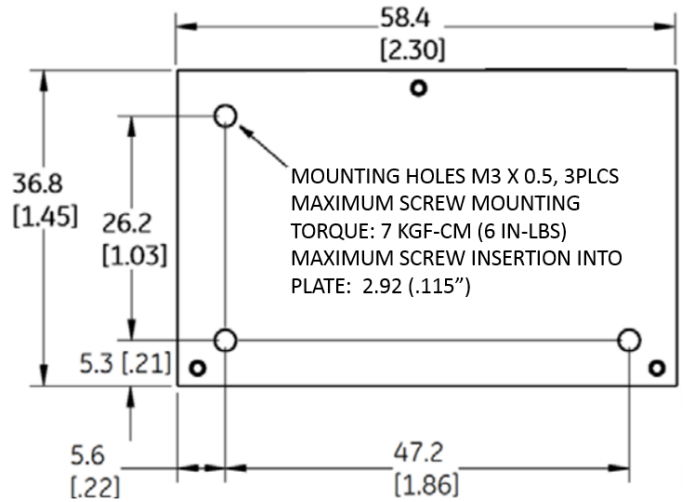

\*Side label includes "GE," product designation, and date code

SIDE VIEWS

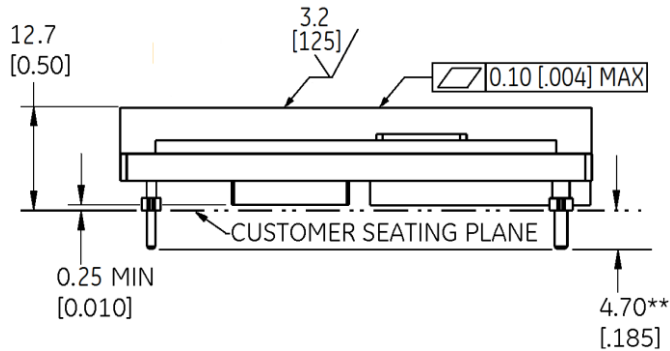

\*\* Standard pin tail length. Optional pin tail lengths shown in Table 2, Device Options.

BOTTOM VIEW\*\*\*

Pin Number	Pin Name
1	VIN(+)
2	ON/OFF
3	VIN(-)
4	VOUT(-)
8	VOUT(+)

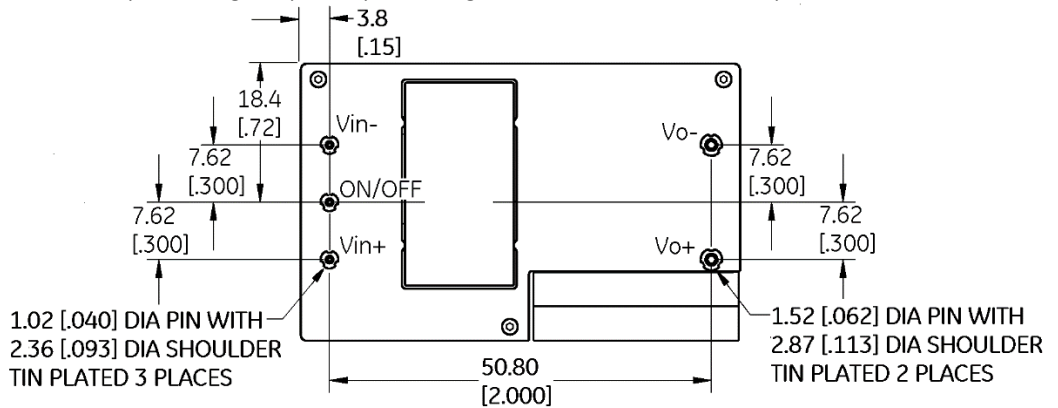

# QBVE067A0B Barracuda; DC-DC Converter Power Modules

40-60Vdc Input; 12.0Vdc, 67.0A, 800W Output

BOTTOM VIEW B\*\*\*

Pin Number	Pin Name
1	VIN(+)
2	ON/OFF
3	VIN(-)
4	VOUT(-)
8	VOUT(+)
9	POWER GOOD
10	SIG_GND
11	DATA
12	SMBALERT
13	CLK
14	ADDR1
15	ADDR0

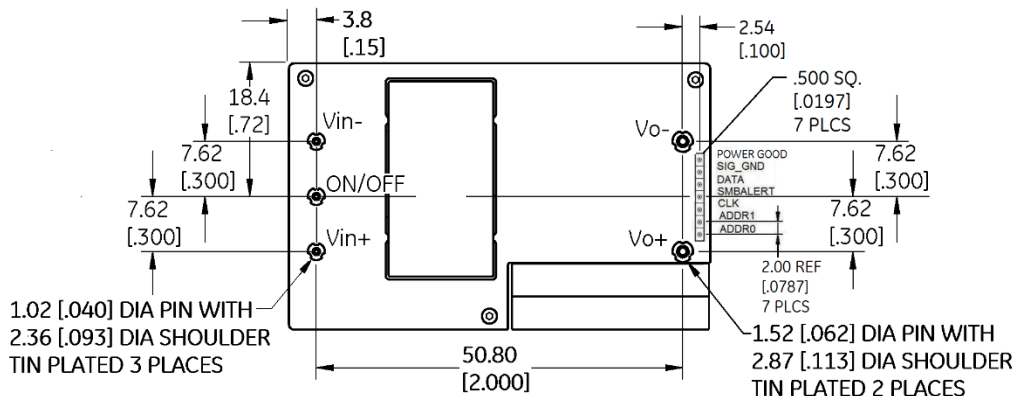

BOTTOM VIEW B is derived from QBDE067A0B, compared to original QBVE067A0B just including the digital signal pins package.

## Recommended Pad Layouts

Dimensions are in millimeters and (inches).  
 Tolerances: x.x mm ± 0.5 mm [x.xx in. ± 0.02 in.] (unless otherwise indicated)  
 x.xx mm ± 0.25 mm [x.xxx in ± 0.010 in.]

Pin Number	Pin Name
1	VIN(+)
2	ON/OFF
3	VIN(-)
4	VOUT(-)
8	VOUT(+)

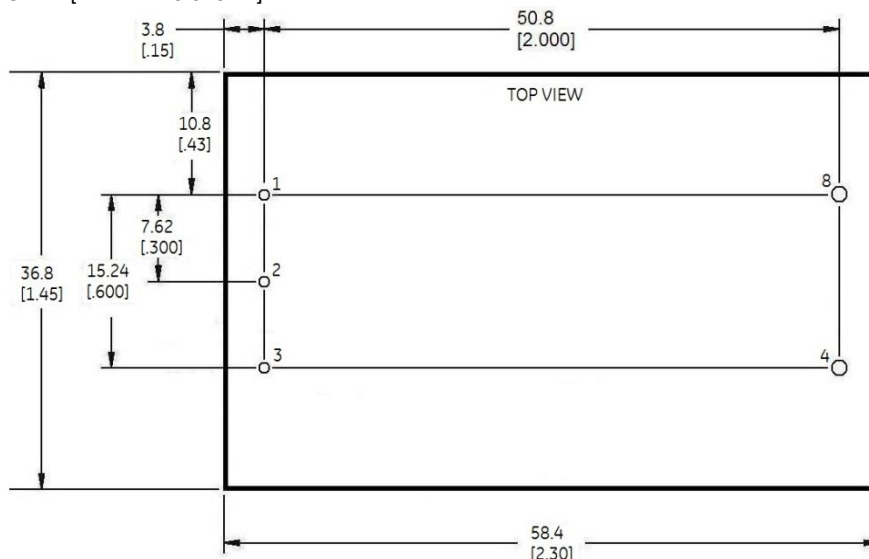

Hole and Pad diameter recommendations:

Pin Number	Hole Dia (mm)	Pad Dia (mm)
1, 2, 3	1.6	2.1
4, 8	2.2	3.2

## QBVE067A0B Barracuda; DC-DC Converter Power Modules

40-60Vdc Input; 12.0Vdc, 67.0A, 800W Output

### Packaging Details

All versions of the QBVE067A0B are supplied as standard in the plastic trays shown in Figure 25.

### Tray Specification

Material	PET (1mm)
Max surface resistivity	$10^9 - 10^{11} \Omega / \text{PET}$
Color	Clear
Capacity	12 power modules
Min order quantity	24 pcs (1 box of 2 full trays + 1 empty top tray)

Each tray contains a total of 12 power modules. The trays are self-stacking and each shipping box for the QBVE067A0B module contains 2 full trays plus one empty hold-down tray giving a total number of 24 power modules.

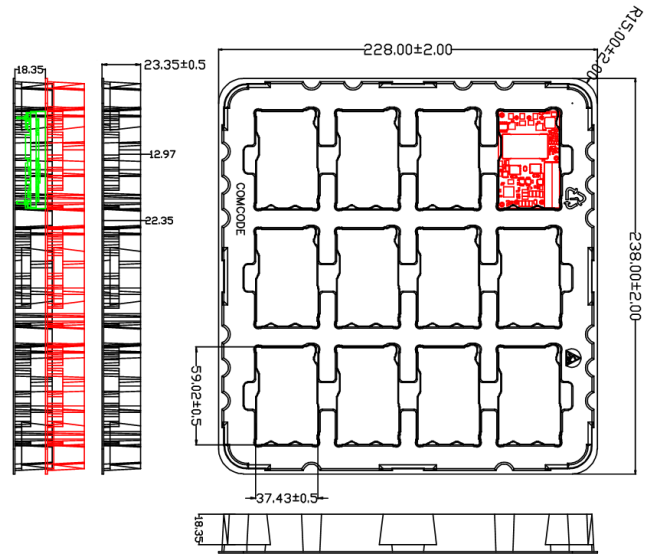

Base Plate Module Tray

Figure 27. QBVE067A0B Packaging Tray

## QBVE067A0B Barracuda; DC-DC Converter Power Modules

40-60Vdc Input; 12.0Vdc, 67.0A, 800W Output

### Ordering Information

Please contact your ABB Sales Representative for pricing, availability and optional features.

**Table 1 Device Codes.**

Product Codes	Input Voltage	Output Voltage	Output Current	Efficiency	Connector Type	MSL Rating	Comcodes
QBVE067A0B41-HZ	48/52/54V (40–60Vdc)	12V	67A	96.1%	Through hole	2a	150040687
QBVE067A0B641-HZ	48/52/54V (40–60Vdc)	12V	67A	96.1%	Through hole	2a	150048509
QBVE067A0B641-02HZ*	48/52/54V (40–60Vdc)	12V	67A	96.1%	Through hole	2a	1600372563A
QBVE067A0B841-HZ	48/52/54V (40–60Vdc)	12V	67A	96.1%	Through hole	2a	150047226
QBVE067A0B41-PHZ	48/52/54V (40–60Vdc)	12V	67A	96.1%	Through hole	2a	150044444

**Table 2. Device Options.**

	Characteristic	Character and Position	Definition
Ratings	Form Factor	Q	<b>Q</b> = Quarter Brick
	Family Designator	BV	<b>BV</b> = BARRACUDA Series
	Input Voltage	E	<b>E</b> = 40V- 60V
	Output Power	067A0	<b>067A0</b> =67.0 Rated Output Current
	Output Voltage	B	<b>B</b> =12.0V nominal
Options	Pin Length	8 6	Omit = Default Pin Length shown in Mechanical Outline Figures <b>8</b> = Pin Length: 2.79 mm ± 0.25mm, (0.110 in. ± 0.010 in.) <b>6</b> = Pin Length: 3.68 mm ± 0.25mm, (0.145 in. ± 0.010 in.)
	Action following Protective Shutdown	4	Omit = Latching Mode <b>4</b> = Auto-restart following shutdown (Overcurrent/Overvoltage)
	On/Off Logic	1	Omit = Positive Logic <b>1</b> = Negative Logic
	Customer Specific	XY	Omit = Standard open Frame Module <b>XY</b> = Customer Specific Modified Code, Omit for Standard Code
	Load Share	P	<b>P</b> = Active Droop Output for use in parallel applications
	Heat Plate	H	<b>H</b> = Heat plate, for use with heat sinks or cold-walls (must be ordered)
	RoHS	Z	<b>Z</b> = RoHS 6/6 Compliant, Lead free

\*QBVE067A0B641-02HZ is identical to QBVE067A0B641-HZ in performance, fit & function, but was derived from QBVE067A0B by removing the digital signal pins.

## Contact Us

For more information, call us at

USA/Canada:

**+1 877 546 3243**, or +1 972 244 9288

Asia-Pacific:

**+86-21-53899666**

Europe, Middle-East and Africa:

**+49.89.878067-280**

[Go.ABB/Industrial](http://Go.ABB/Industrial)

ABB reserves the right to make changes to the product(s) or information contained herein without notice, and no liability is assumed as a result of their use or application. No rights under any patent accompany the sale of any such product(s) or information.