



SGM8295-1/SGM8295-2/SGM8295-4 9MHz, Low Noise, High Voltage, Precision Operational Amplifiers

GENERAL DESCRIPTION

The SGM8295-1/2/4 are a family of single, dual and quad operational amplifiers, which are optimized for high voltage, low noise and low offset voltage operation. These devices can operate from 3.6V to 36V single supply or from $\pm 1.8V$ to $\pm 18V$ dual supplies, while consuming only 1.5mA quiescent current per amplifier.

They exhibit a high gain-bandwidth product of 9MHz and a slew rate of 8V/ μ s. The output swing is rail-to-rail with heavy loads. These specifications make the operational amplifiers appropriate for various applications.

The SGM8295-1 is available in Green SOT-23-5 and SOIC-8 packages. The SGM8295-2 is available in Green SOIC-8 and MSOP-8 packages. The SGM8295-4 is available in a Green SOIC-14 package. They are specified over the extended $-40^{\circ}C$ to $+125^{\circ}C$ temperature range.

FEATURES

- **Low Noise:** $4.5nV/\sqrt{Hz}$
- **Input Offset Voltage:** 250 μ V (MAX)
- **Low Bias Current:** $\pm 1nA$ (TYP)
- **High Gain-Bandwidth Product:** 9MHz
- **High Slew Rate:** 8V/ μ s
- **High Open-Loop Gain:** 130dB at $V_S = \pm 15V$
- **High PSRR:** 145dB
- **Settling Time to 0.1% with 1V Step:** 1 μ s
- **Overload Recovery Time:** 10 μ s
- **Rail-to-Rail Output**
- **Supply Voltage Range:**
3.6V to 36V or $\pm 1.8V$ to $\pm 18V$
- **Input Common Mode Voltage Range:**
 $(-V_S) + 1.5V$ to $(+V_S) - 2V$
- **Low Supply Current:** 1.5mA/Amplifier (TYP)
- **$-40^{\circ}C$ to $+125^{\circ}C$ Operating Temperature Range**
- **Small Packaging:**
 - SGM8295-1 Available in Green SOT-23-5 and SOIC-8 Packages
 - SGM8295-2 Available in Green SOIC-8 and MSOP-8 Packages
 - SGM8295-4 Available in a Green SOIC-14 Package

APPLICATIONS

Sensors
Audio
Active Filters
A/D Converters
Communications
Test Equipment
Cellular and Cordless Phones
Laptops and PDAs
Photodiode Amplification

PACKAGE/ORDERING INFORMATION

MODEL	PACKAGE DESCRIPTION	SPECIFIED TEMPERATURE RANGE	ORDERING NUMBER	PACKAGE MARKING	PACKING OPTION
SGM8295-1	SOT-23-5	-40°C to +125°C	SGM8295-1XN5G/TR	G62XX	Tape and Reel, 3000
	SOIC-8	-40°C to +125°C	SGM8295-1XS8G/TR	SGM 82951XS8 XXXXX	Tape and Reel, 2500
SGM8295-2	SOIC-8	-40°C to +125°C	SGM8295-2XS8G/TR	SGM 82952XS8 XXXXX	Tape and Reel, 2500
	MSOP-8	-40°C to +125°C	SGM8295-2XMS8G/TR	SGM82952 XMS8 XXXXX	Tape and Reel, 4000
SGM8295-4	SOIC-14	-40°C to +125°C	SGM8295-4XS14G/TR	SGM82954XS14 XXXXX	Tape and Reel, 2500

MARKING INFORMATION

NOTE: XX = Date Code. XXXXX = Date Code and Vendor Code.

SOT-23-5

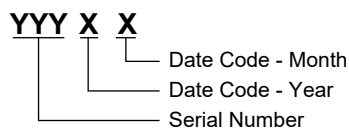

SOIC-8/MSOP-8/SOIC-14

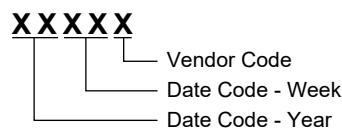

Green (RoHS & HSF): SG Micro Corp defines "Green" to mean Pb-Free (RoHS compatible) and free of halogen substances. If you have additional comments or questions, please contact your SGMICRO representative directly.

ABSOLUTE MAXIMUM RATINGS

- Supply Voltage, +Vs to -Vs 40V
- Input Common Mode Voltage Range (-Vs) - 0.3V to (+Vs) + 0.3V
- Junction Temperature +150°C
- Storage Temperature Range -65°C to +150°C
- Lead Temperature (Soldering, 10s) +260°C
- ESD Susceptibility
- HBM 4000V
- MM 200V
- CDM 1000V

RECOMMENDED OPERATING CONDITIONS

- Supply Voltage Range 3.6V to 36V
- Operating Temperature Range -40°C to +125°C

OVERSTRESS CAUTION

Stresses beyond those listed in Absolute Maximum Ratings may cause permanent damage to the device. Exposure to

absolute maximum rating conditions for extended periods may affect reliability. Functional operation of the device at any conditions beyond those indicated in the Recommended Operating Conditions section is not implied.

ESD SENSITIVITY CAUTION

This integrated circuit can be damaged if ESD protections are not considered carefully. SGMICRO recommends that all integrated circuits be handled with appropriate precautions. Failure to observe proper handling and installation procedures can cause damage. ESD damage can range from subtle performance degradation to complete device failure. Precision integrated circuits may be more susceptible to damage because even small parametric changes could cause the device not to meet the published specifications.

DISCLAIMER

SG Micro Corp reserves the right to make any change in circuit design, or specifications without prior notice.

PIN CONFIGURATIONS

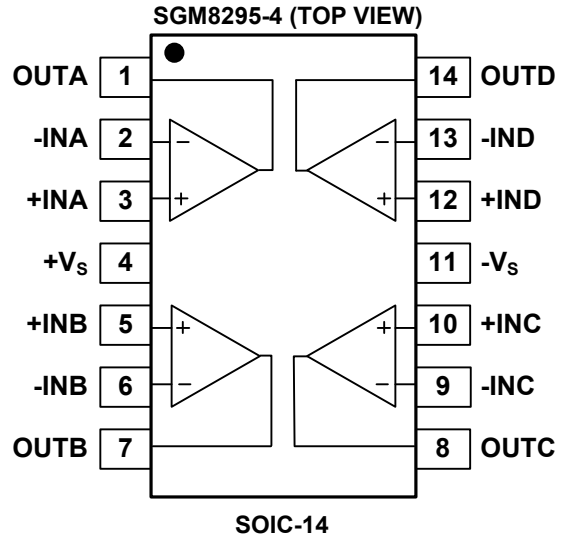
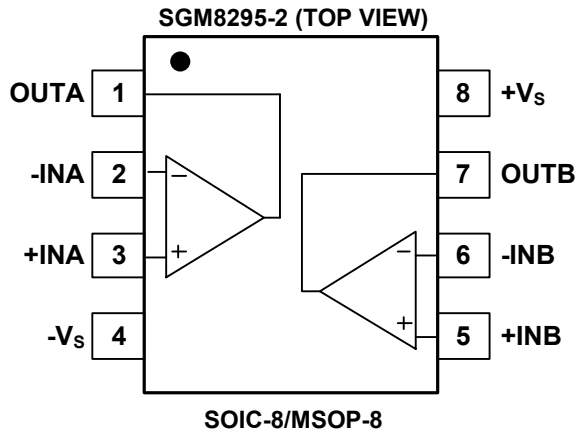
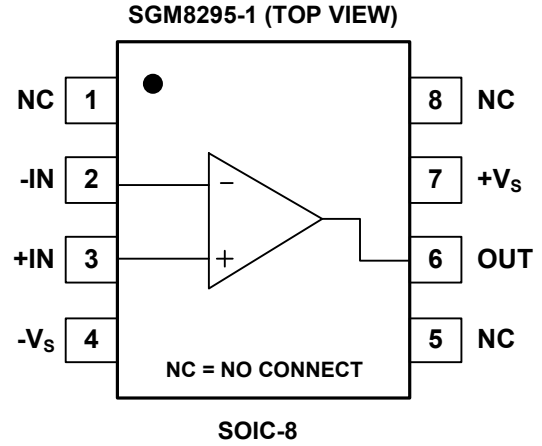
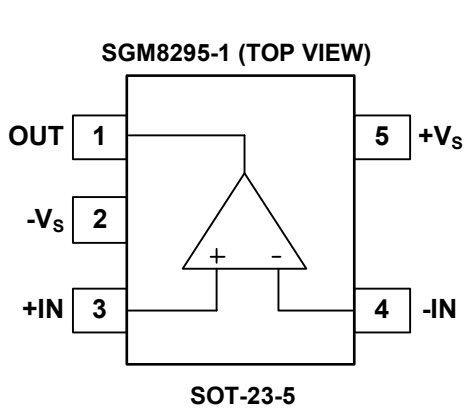

ELECTRICAL CHARACTERISTICS

(At $T_A = +25^\circ\text{C}$, $V_S = \pm 5\text{V}$ to $V_S = \pm 15\text{V}$, $V_{CM} = 0\text{V}$, $V_{OUT} = 0\text{V}$ and R_L connected to 0V , Full = -40°C to $+125^\circ\text{C}$, unless otherwise noted.)

PARAMETER	SYMBOL	CONDITIONS	TEMP	MIN	TYP	MAX	UNITS
Input Characteristics							
Input Offset Voltage	V_{OS}		+25°C		50	250	μV
			Full			360	
Input Bias Current	I_B	$V_{CM} = V_S/2$	+25°C		± 1	± 17	nA
			Full			± 52	
Input Offset Current	I_{OS}	$V_{CM} = V_S/2$	+25°C		± 1	± 21	nA
			Full			± 45	
Input Common Mode Voltage Range	V_{CM}		Full	$(-V_S) + 1.5$		$(+V_S) - 2$	V
Common Mode Rejection Ratio	CMRR	$(-V_S) + 1.5\text{V} \leq V_{CM} \leq (+V_S) - 2\text{V}$	+25°C	112	140		dB
			Full	110			
Open-Loop Voltage Gain	A_{OL}	$V_S = \pm 5\text{V}, V_{OUT} = \pm 2.5\text{V}, R_L = 10\text{k}\Omega$	+25°C	118	135		dB
			Full	116			
		$V_S = \pm 15\text{V}, V_{OUT} = \pm 10\text{V}, R_L = 10\text{k}\Omega$	+25°C	124	140		
			Full	122			
		$V_S = \pm 5\text{V}, V_{OUT} = \pm 2.5\text{V}, R_L = 2\text{k}\Omega$	+25°C	108	130		
			Full	106			
		$V_S = \pm 15\text{V}, V_{OUT} = \pm 10\text{V}, R_L = 2\text{k}\Omega$	+25°C	118	130		
			Full	110			
Input Offset Voltage Drift	$\Delta V_{OS}/\Delta T$		Full		0.4		$\mu\text{V}/^\circ\text{C}$
Output Characteristics							
Output Voltage Swing from Rail	V_{OUT}	$V_S = \pm 15\text{V}, R_L = 10\text{k}\Omega$	+25°C		65	95	mV
			Full			125	
		$V_S = \pm 15\text{V}, R_L = 2\text{k}\Omega$	+25°C		310	450	
			Full			600	
Output Short-Circuit Current	I_{SC}		+25°C	± 28	± 50		mA
Power Supply							
Operating Voltage Range	V_S		Full	3.6		36	V
Quiescent Current/Amplifier	I_Q	$I_{OUT} = 0\text{mA}$	+25°C		1.5	2	mA
			Full			2.2	
Power Supply Rejection Ratio	PSRR	$V_S = 3\text{V to } 38\text{V}$	+25°C	121	145		dB
			Full	119			
Dynamic Performance							
Gain-Bandwidth Product	GBP	$V_{OUT} = 100\text{mV}_{P-P}, R_L = 2\text{k}\Omega$	+25°C		9		MHz
Slew Rate	SR	$R_L = 2\text{k}\Omega$	+25°C		8		$\text{V}/\mu\text{s}$
Settling Time to 0.1%	t_s	$V_{IN} = 1\text{V Step}, R_L = 2\text{k}\Omega, G = +1$	+25°C		1		μs
Overload Recovery Time		$R_L = 2\text{k}\Omega, V_{IN} \times G = V_S$	+25°C		10		μs
Phase Margin	ϕ_O	$V_{OUT} = 100\text{mV}_{P-P}, R_L = 2\text{k}\Omega, C_L = 10\text{pF}$	+25°C		45		$^\circ$
Total Harmonic Distortion + Noise	THD+N	$V_{IN} = 1\text{V}_{RMS}, G = +1, R_L = 2\text{k}\Omega, f = 1\text{kHz}$	+25°C		0.0001		%
Noise							
Input Voltage Noise		$f = 0.1\text{Hz to } 10\text{Hz}$	+25°C		280		nV_{P-P}
Input Voltage Noise Density	e_n	$f = 1\text{kHz}$	+25°C		4.5		$\text{nV}/\sqrt{\text{Hz}}$
Input Current Noise Density	i_n	$f = 1\text{kHz}$	+25°C		2		$\text{pA}/\sqrt{\text{Hz}}$

TYPICAL PERFORMANCE CHARACTERISTICS

At $T_A = +25^\circ\text{C}$ and $V_S = \pm 15\text{V}$, unless otherwise noted.

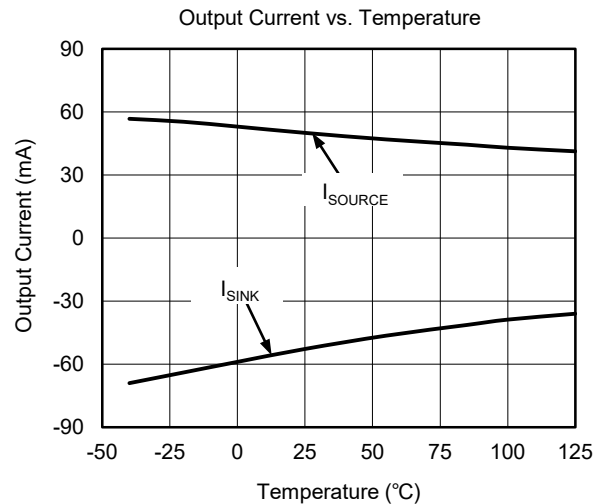
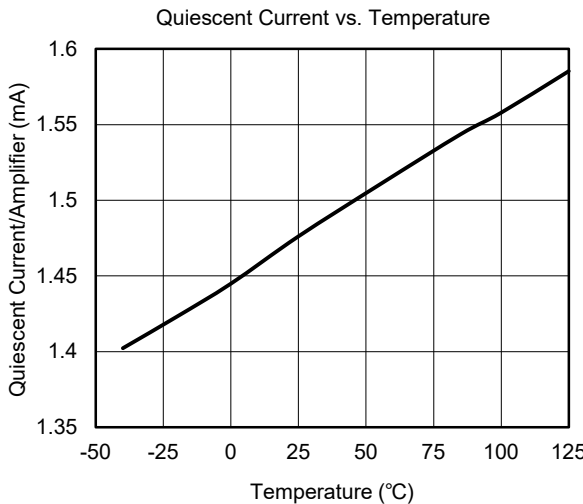
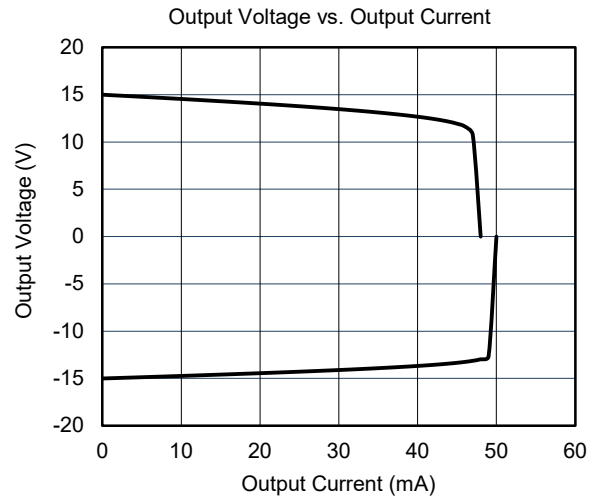
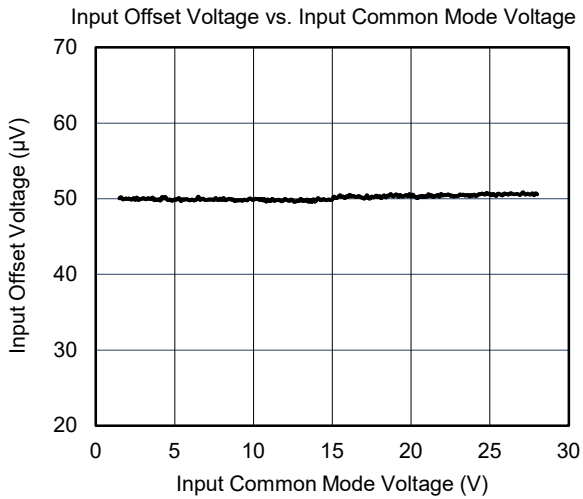
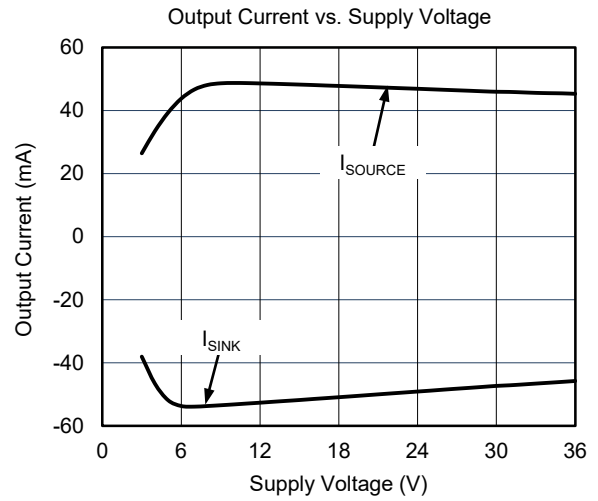
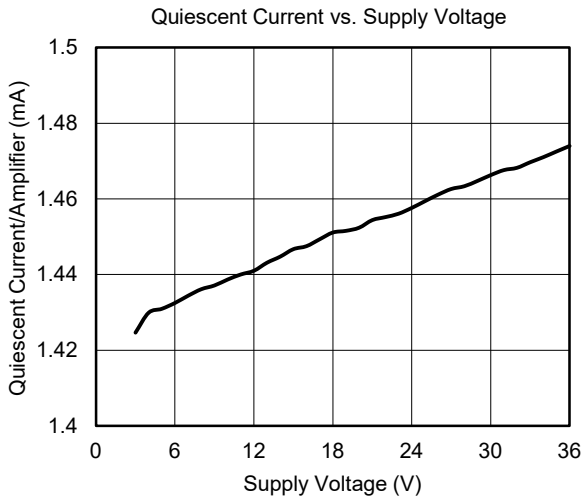

TYPICAL PERFORMANCE CHARACTERISTICS (continued)

At $T_A = +25^\circ\text{C}$ and $V_S = \pm 15\text{V}$, unless otherwise noted.

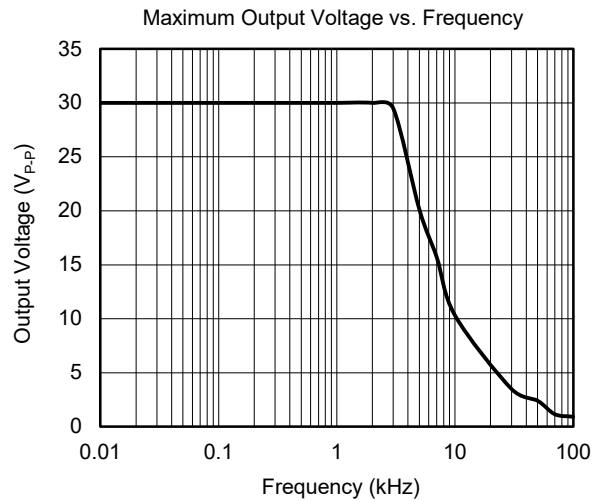
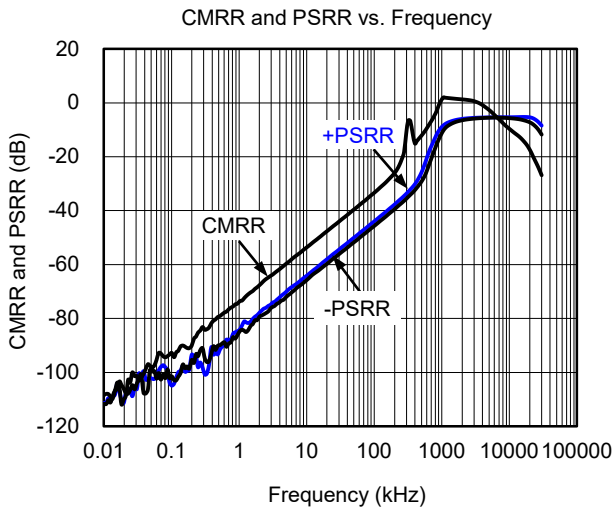
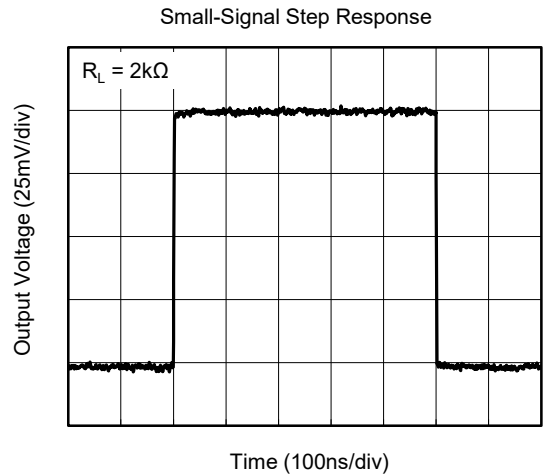
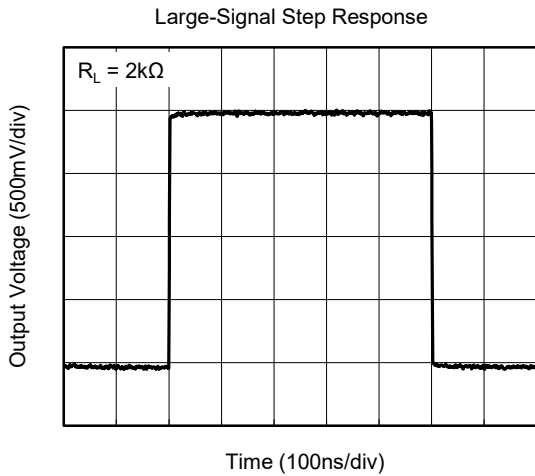
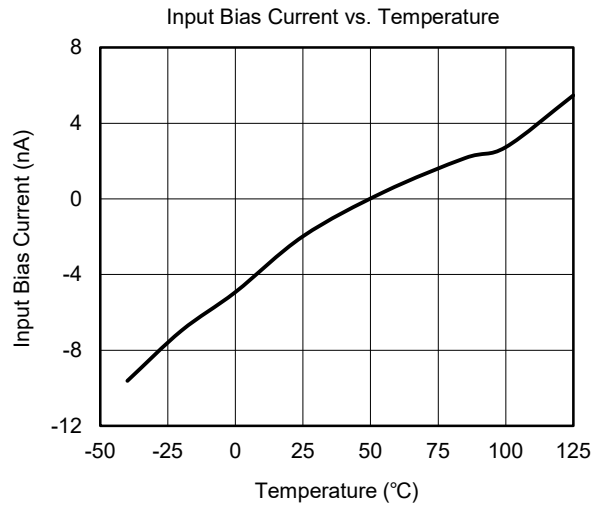
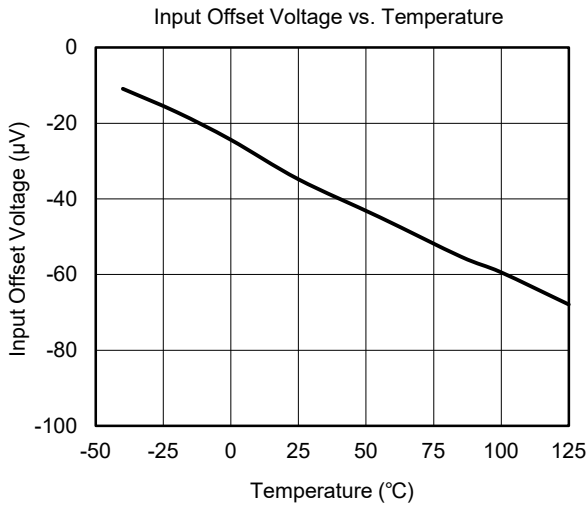

TYPICAL PERFORMANCE CHARACTERISTICS (continued)

At $T_A = +25^\circ\text{C}$ and $V_S = \pm 15\text{V}$, unless otherwise noted.

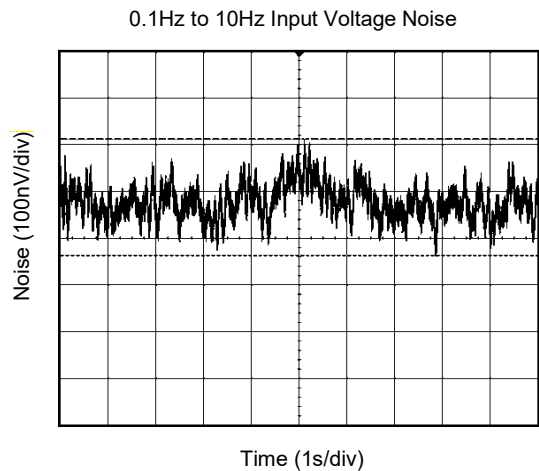
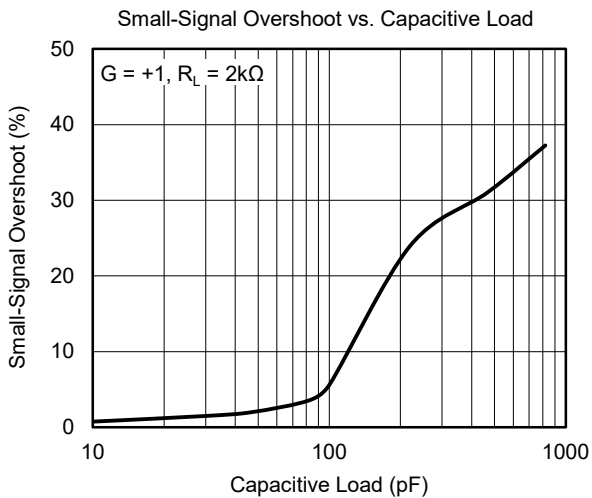
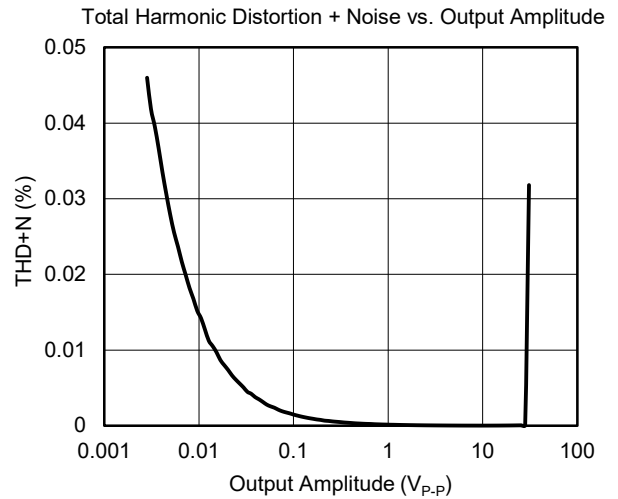
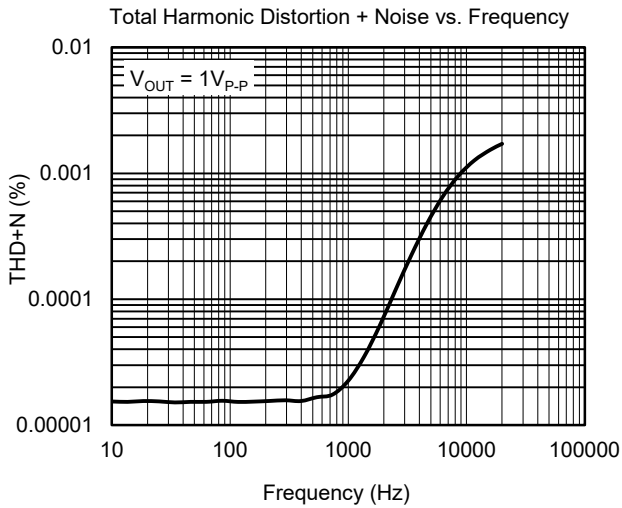
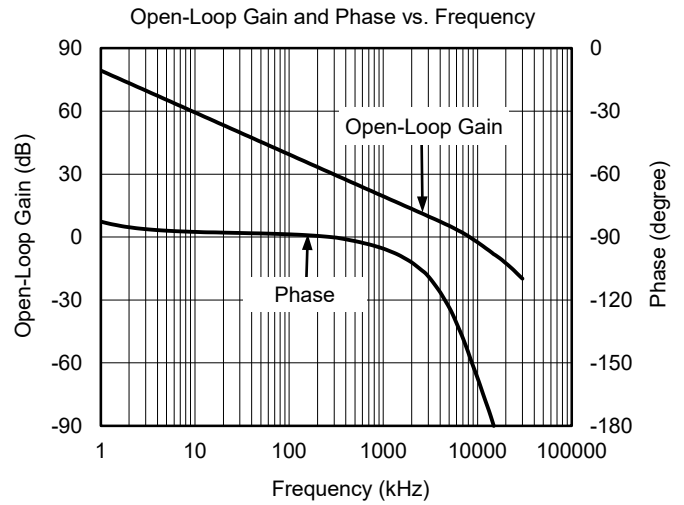
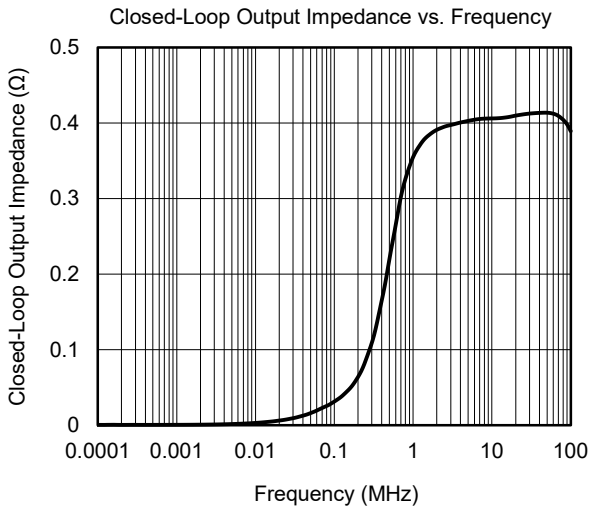

TYPICAL PERFORMANCE CHARACTERISTICS (continued)

At $T_A = +25^\circ\text{C}$ and $V_S = \pm 15\text{V}$, unless otherwise noted.

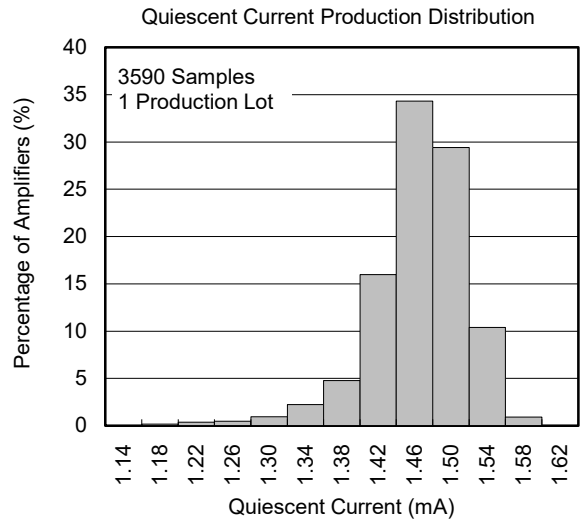
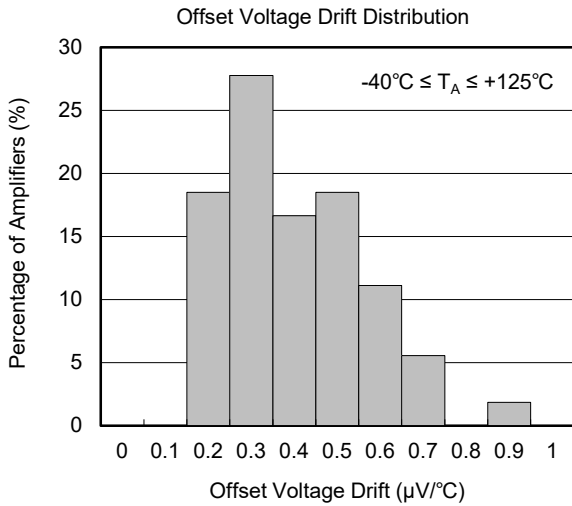
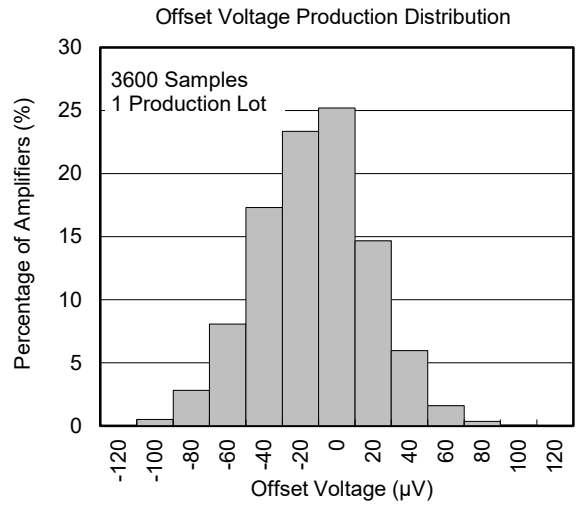
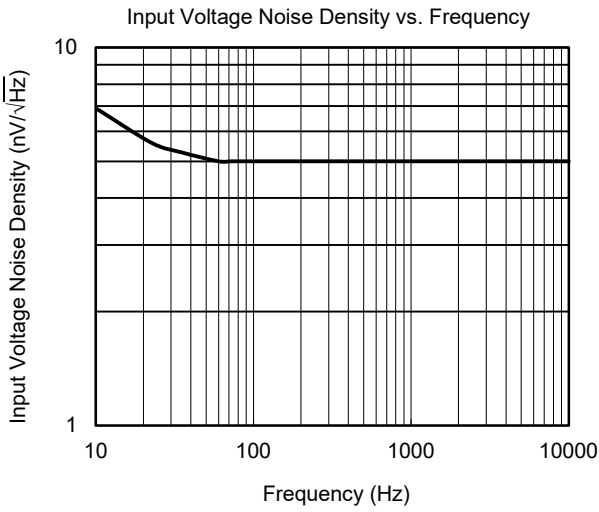

REVISION HISTORY

NOTE: Page numbers for previous revisions may differ from page numbers in the current version.

AUGUST 2017 – REV.A to REV.A.1	Page
Updated open-loop gain and phase vs. frequency	7

Changes from Original (AUGUST 2017) to REV.A	Page
Changed from product preview to production data	All

PACKAGE OUTLINE DIMENSIONS

SOT-23-5

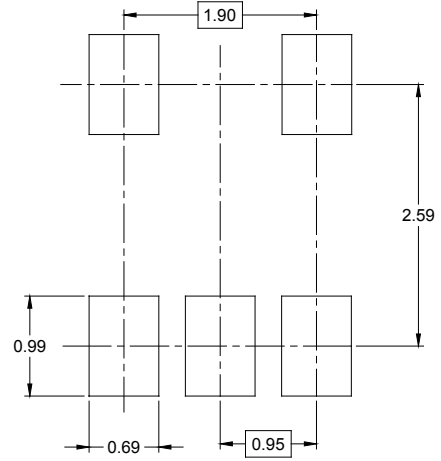

RECOMMENDED LAND PATTERN (Unit: mm)



Symbol	Dimensions In Millimeters		Dimensions In Inches	
	MIN	MAX	MIN	MAX
A	1.050	1.250	0.041	0.049
A1	0.000	0.100	0.000	0.004
A2	1.050	1.150	0.041	0.045
b	0.300	0.500	0.012	0.020
c	0.100	0.200	0.004	0.008
D	2.820	3.020	0.111	0.119
E	1.500	1.700	0.059	0.067
E1	2.650	2.950	0.104	0.116
e	0.950 BSC		0.037 BSC	
e1	1.900 BSC		0.075 BSC	
L	0.300	0.600	0.012	0.024
θ	0°	8°	0°	8°

PACKAGE OUTLINE DIMENSIONS

SOIC-8

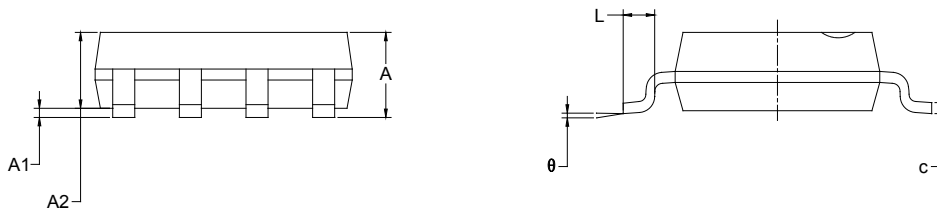
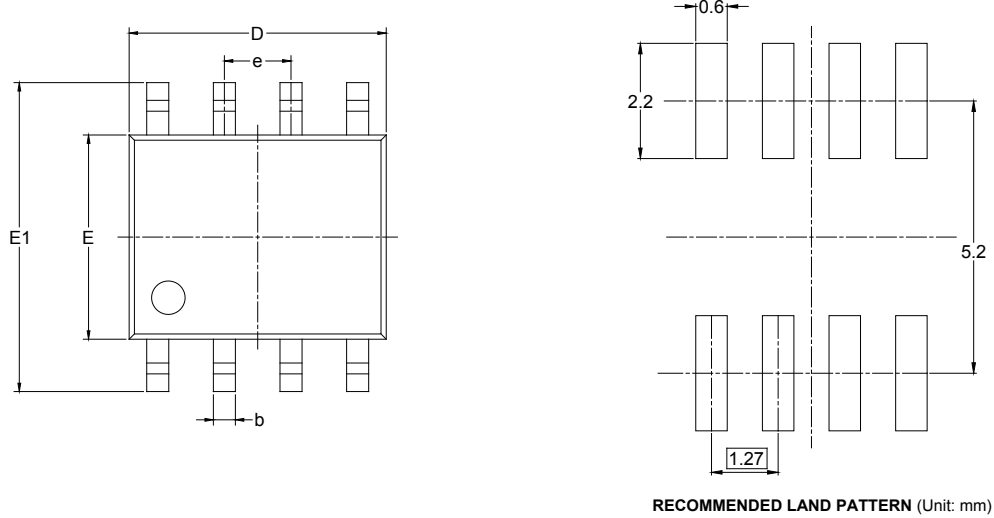

Symbol	Dimensions In Millimeters		Dimensions In Inches	
	MIN	MAX	MIN	MAX
A	1.350	1.750	0.053	0.069
A1	0.100	0.250	0.004	0.010
A2	1.350	1.550	0.053	0.061
b	0.330	0.510	0.013	0.020
c	0.170	0.250	0.006	0.010
D	4.700	5.100	0.185	0.200
E	3.800	4.000	0.150	0.157
E1	5.800	6.200	0.228	0.244
e	1.27 BSC		0.050 BSC	
L	0.400	1.270	0.016	0.050
θ	0°	8°	0°	8°

PACKAGE OUTLINE DIMENSIONS

MSOP-8

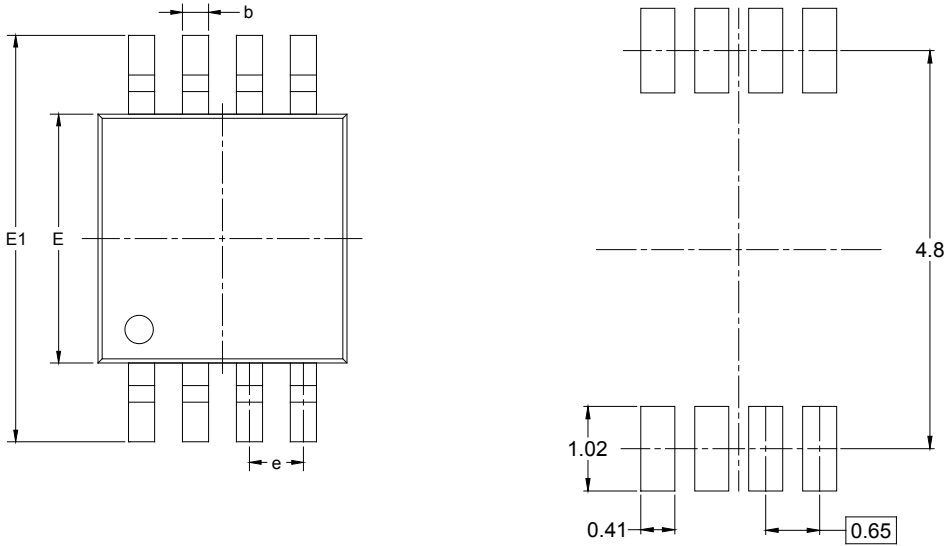

RECOMMENDED LAND PATTERN (Unit: mm)

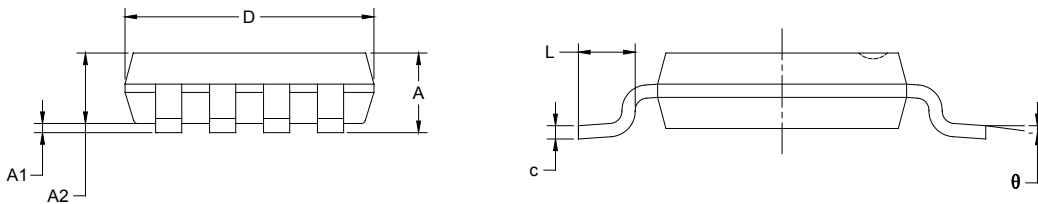

Symbol	Dimensions In Millimeters		Dimensions In Inches	
	MIN	MAX	MIN	MAX
A	0.820	1.100	0.032	0.043
A1	0.020	0.150	0.001	0.006
A2	0.750	0.950	0.030	0.037
b	0.250	0.380	0.010	0.015
c	0.090	0.230	0.004	0.009
D	2.900	3.100	0.114	0.122
E	2.900	3.100	0.114	0.122
E1	4.750	5.050	0.187	0.199
e	0.650 BSC		0.026 BSC	
L	0.400	0.800	0.016	0.031
θ	0°	6°	0°	6°

PACKAGE INFORMATION

PACKAGE OUTLINE DIMENSIONS

SOIC-14

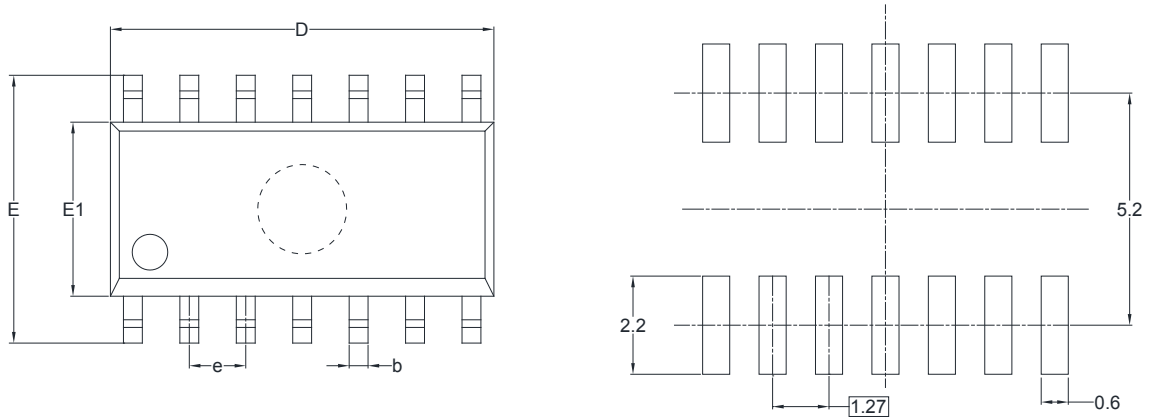

RECOMMENDED LAND PATTERN (Unit: mm)

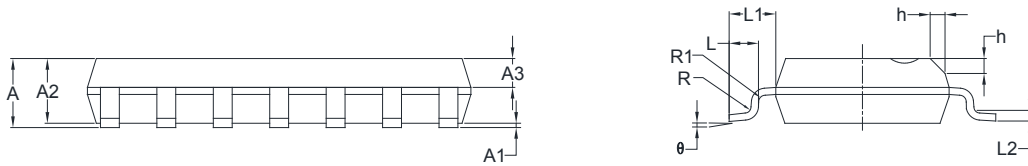

Symbol	Dimensions In Millimeters		Dimensions In Inches	
	MIN	MAX	MIN	MAX
A	1.35	1.75	0.053	0.069
A1	0.10	0.25	0.004	0.010
A2	1.25	1.65	0.049	0.065
A3	0.55	0.75	0.022	0.030
b	0.36	0.49	0.014	0.019
D	8.53	8.73	0.336	0.344
E	5.80	6.20	0.228	0.244
E1	3.80	4.00	0.150	0.157
e	1.27 BSC		0.050 BSC	
L	0.45	0.80	0.018	0.032
L1	1.04 REF		0.040 REF	
L2	0.25 BSC		0.01 BSC	
R	0.07		0.003	
R1	0.07		0.003	
h	0.30	0.50	0.012	0.020
θ	0°	8°	0°	8°

PACKAGE INFORMATION

TAPE AND REEL INFORMATION

REEL DIMENSIONS



TAPE DIMENSIONS



NOTE: The picture is only for reference. Please make the object as the standard.

KEY PARAMETER LIST OF TAPE AND REEL

Package Type	Reel Diameter	Reel Width W1 (mm)	A0 (mm)	B0 (mm)	K0 (mm)	P0 (mm)	P1 (mm)	P2 (mm)	W (mm)	Pin1 Quadrant
SOT-23-5	7"	9.5	3.20	3.20	1.40	4.0	4.0	2.0	8.0	Q3
SOIC-8	13"	12.4	6.40	5.40	2.10	4.0	8.0	2.0	12.0	Q1
MSOP-8	13"	12.4	5.20	3.30	1.50	4.0	8.0	2.0	12.0	Q1
SOIC-14	13"	16.4	6.60	9.30	2.10	4.0	8.0	2.0	16.0	Q1

DD0001

PACKAGE INFORMATION

CARTON BOX DIMENSIONS



NOTE: The picture is only for reference. Please make the object as the standard.

KEY PARAMETER LIST OF CARTON BOX

Reel Type	Length (mm)	Width (mm)	Height (mm)	Pizza/Carton
7" (Option)	368	227	224	8
7"	442	410	224	18
13"	386	280	370	5

DD0002