

Features

- ◇ 150W (8/20μs) Peak Pulse Power
- ◇ Ultra Low Capacitance ESD Protection
- ◇ Flow Through SOT-563 Package
- ◇ RoHS Compliant
- ◇ Matte Tin Lead Finish (Pb-Free)
- ◇ Protect Two High Speed Data Lines
- ◇ Meet IEC61000-4-2 Level 4:
 - Contact Discharge > 15kV
 - Air Discharge > 20kV

Applications

- ◇ USB 2.0 High Speed Ports
- ◇ Video Graphics Cards
- ◇ Digital Visual Interface (DVI)
- ◇ 10/100/1000 Ethernet Ports
- ◇ Monitors and Flat Panel Displays
- ◇ IEEE 1394 Firewire Ports High Speed
- ◇ High Definition Multi-Media Interface (HDMI)

Ordering information

Device	Package	Marking
USBLC6-2P6	SOT-563	F

Circuit Diagram

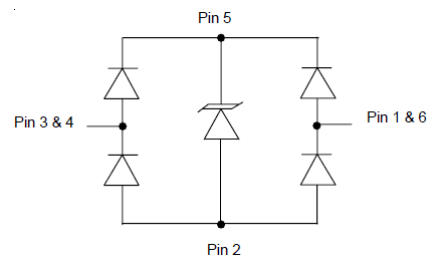

PIN Diagram

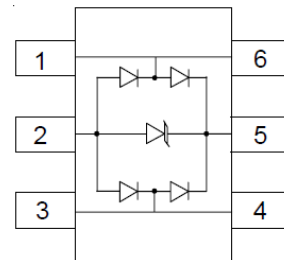

Absolute Maximum Ratings (T_A=25°C unless otherwise specified)

Symbol	Parameter	Value	Unit
PPK	Peak Pulse Power	150	W
IPP	Peak Pulse Current	5	A
VESD (Contact)	Contact ESD Voltage per IEC61000-4-2	15	kV
VESD (Air)	Air ESD Voltage per IEC61000-4-2	20	kV
TJ	Junction Temperature	-55 to +125	°C
TSTG	Storage Temperature	-55 to +150	°C

USBLC6-2P6

Electrical Characteristics ($T_A=25^{\circ}\text{C}$ unless otherwise specified)

Symbol	Parameter	Conditions	Min	Typ	Max	Unit
VRWM	Reverse Working Peak Voltage				5	V
VBR	Reverse Breakdown Voltage	$I_T = 1\text{mA}$	6			V
IR	Reverse Leakage Current	VRWM = 5V			1	μA
VC	Clamping Voltage	IPP = 1A (8/20 μs)			13	V
CJ	Capacitance	VR = 0V, f = 1MHz Between I/O pins			0.8	pF
CJ	Capacitance	VR = 0V, f = 1MHz Any I/O pin to ground			1.5	pF

RATING AND CHARACTERISTIC CURVES (USBLC6-2P6)

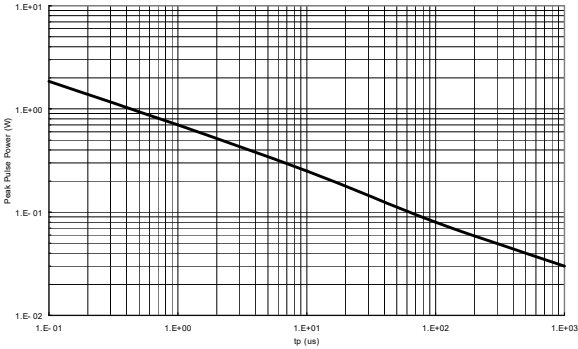

Figure 1. Peak Pulse Power Derating

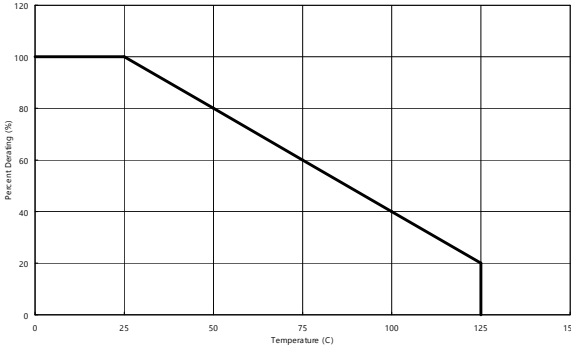

Figure 2. Peak Pulse Power Derating vs Temperature

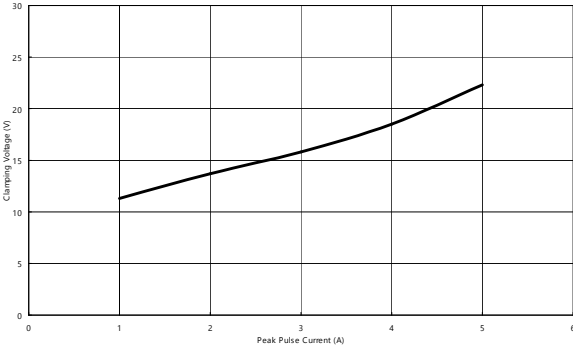

Figure 3. Peak Pulse Current vs Clamping Voltage

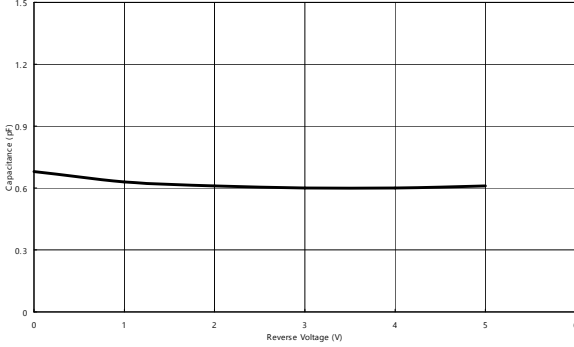
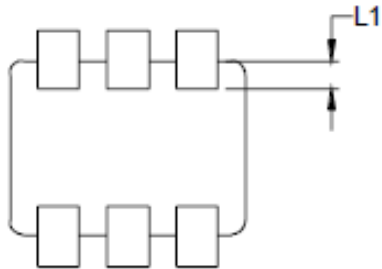
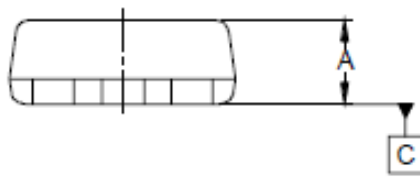
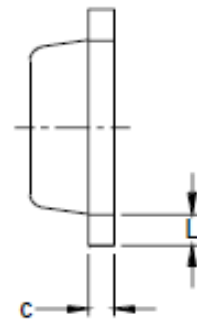
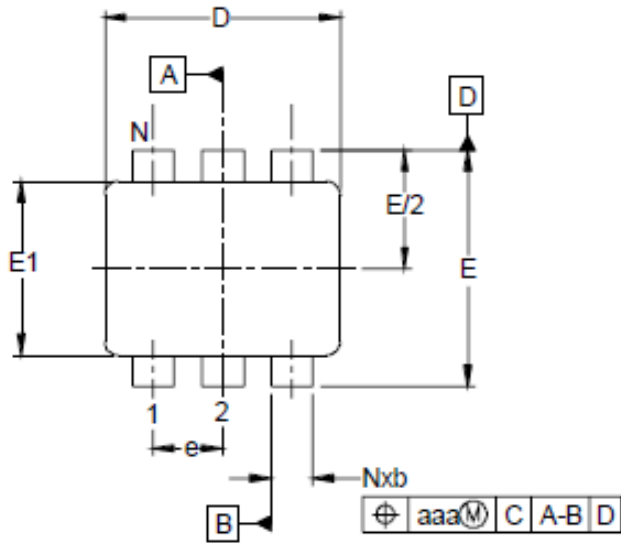

Figure 4. Reverse Voltage vs Capacitance

SOT-563 PACKAGE OUTLINE DIMENSIO



DIM	INCHES			MILLIMETERS		
	MIN	NOM	MAX	MIN	NOM	MAX
A	.019	-	.024	0.50	-	0.60
b	.005	-	.012	0.15	-	0.30
c	.003	-	.007	0.10	-	0.18
D	.059	.063	.087	1.50	1.60	1.70
E	.061	.063	.067	1.55	1.60	1.70
E1	.043	.047	.049	1.10	1.20	1.25
e	.020 BSC			0.50 BSC		
L	.003	.008	.012	0.10	0.20	0.30
L1	.003	.008	.008	0.10	0.15	0.20
N	6			6		
aaa	.004			0.10		