

# SI2302

N-Channel 20-V(D-S) MOSFET

$V_{(BR)DSS}$	$R_{DS(on)MAX}$	$I_D$
20V	0.050Ω@4.5V	3A
	0.065Ω@2.5V	

### General FEATURE

- TrenchFET Power MOSFET
- Lead free product is acquired
- Surface mount package

### APPLICATION

- Load Switch for Portable Devices
- DC/DC Converter

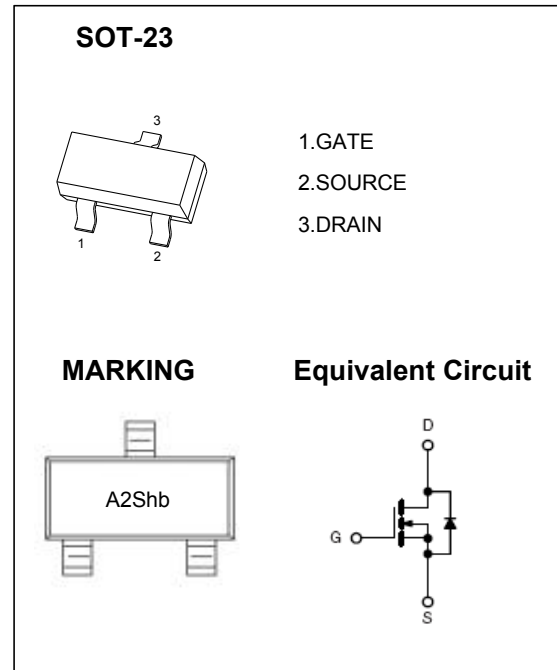

Maximum ratings ( $T_a=25^{\circ}\text{C}$  unless otherwise noted)

Parameter	Symbol	Value	Unit
Drain-Source Voltage	$V_{DS}$	20	V
Gate-Source Voltage	$V_{GS}$	$\pm 10$	
Continuous Drain Current	$I_D$	3.0	A
Pulsed Drain Current*1	$I_{DM}$	10	
Continuous Source-Drain Diode Current	$I_S$	1.0	
Maximum Power Dissipation	$P_D$	1.0	W
Thermal Resistance from Junction to Ambient( $t \leq 5s$ )	$R_{\theta JA}$	156	$^{\circ}\text{C}/\text{W}$
Junction Temperature	$T_J$	150	$^{\circ}\text{C}$
Storage Temperature	$T_{stg}$	-55 ~ +150	

Note :

\*1. Pulse Width  $\leq 300\mu\text{s}$ , Duty cycle  $\leq 2\%$

**MOSFET ELECTRICAL CHARACTERISTICS**
**T<sub>a</sub> =25 °C unless otherwise specified**

Parameter	Symbol	Test Condition	Min	Typ	Max	Units
<b>Static</b>						
Drain-source breakdown voltage	V <sub>(BR)DSS</sub>	V <sub>GS</sub> = 0V, I <sub>D</sub> = -250μA	20			V
Gate-source threshold voltage	V <sub>GS(th)</sub>	V <sub>DS</sub> = V <sub>GS</sub> , I <sub>D</sub> = -250μA	0.5	0.8	1.0	
Gate-source leakage	I <sub>GSS</sub>	V <sub>DS</sub> = 0V, V <sub>GS</sub> = ±10V			±100	nA
Zero gate voltage drain current	I <sub>DSS</sub>	V <sub>DS</sub> = 16V, V <sub>GS</sub> = 0V			1	μA
Drain-source on-state resistance <sup>a</sup>	R <sub>DS(on)</sub>	V <sub>GS</sub> = 4.5V, I <sub>D</sub> = 3A		0.045	0.050	Ω
		V <sub>GS</sub> = 2.5V, I <sub>D</sub> = 2A		0.055	0.065	
Forward transconductance <sup>a</sup>	g <sub>fs</sub>	V <sub>DS</sub> = 5V, I <sub>D</sub> = 3A		8.0	-	S
<b>Dynamic<sup>b</sup></b>						
Input capacitance	C <sub>iss</sub>	V <sub>DS</sub> = 10V, V <sub>GS</sub> = 0V, f = 1MHz		300		pF
Output capacitance	C <sub>oss</sub>			120		
Reverse transfer capacitance	C <sub>rss</sub>			80		
Total gate charge	Q <sub>g</sub>	V <sub>DS</sub> = 10V, V <sub>GS</sub> = 4.5V, I <sub>D</sub> = 3A		4.0		nC
Gate-source charge	Q <sub>gs</sub>			0.65		
Gate-drain charge	Q <sub>gd</sub>			1.6		
Turn-on delay time	t <sub>d(on)</sub>	V <sub>DD</sub> = 10V, I <sub>D</sub> = 3A V <sub>GEN</sub> = 4.5V, R <sub>g</sub> = 6Ω		15.0		ns
Rise time	t <sub>r</sub>			85.0		
Turn-off delay time	t <sub>d(off)</sub>			45.0		
Fall time	t <sub>f</sub>			20.0		
<b>Drain-source body diode characteristics</b>						
Continuous source-drain diode current	I <sub>S</sub>	T <sub>C</sub> = 25°C			1.0	A
Body diode voltage	V <sub>SD</sub>	I <sub>S</sub> = 1.0A		0.7	1.3	V

**Notes :**

- a. Pulse Test : Pulse Width < 300μs, Duty Cycle ≤ 2%.
- b. Guaranteed by design, not subject to production testing.

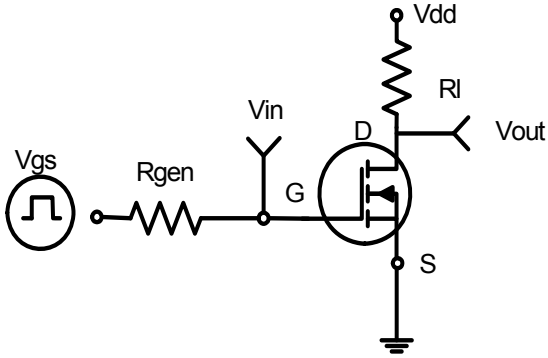
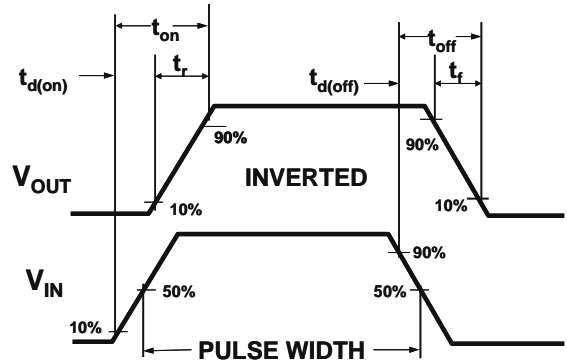
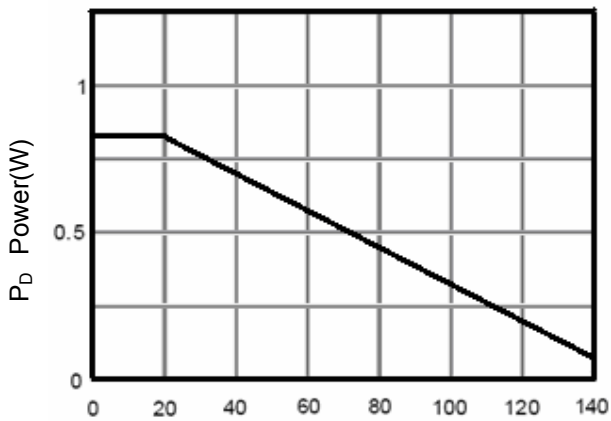
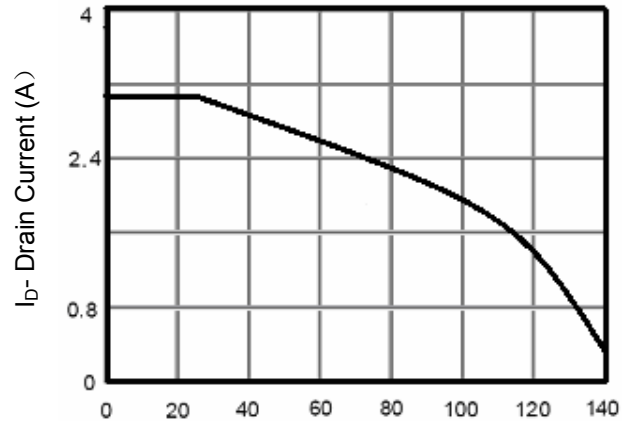
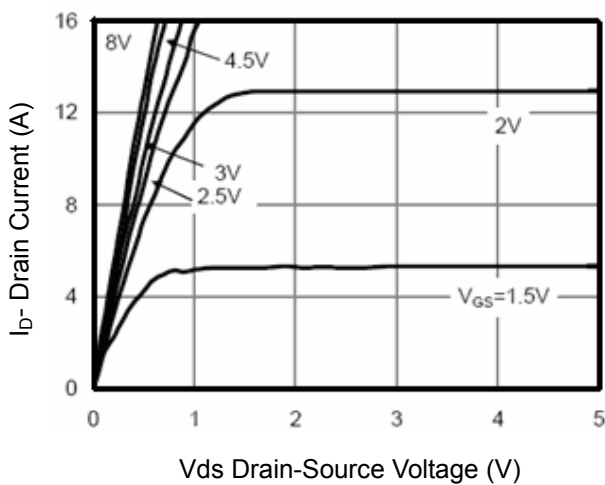
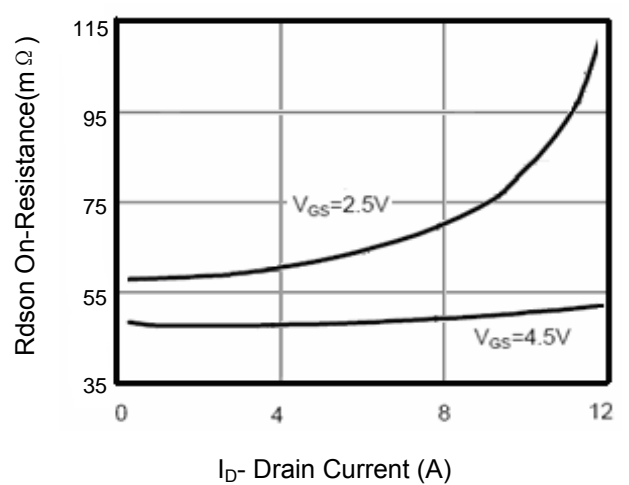
**Typical Electrical and Thermal Characteristics**

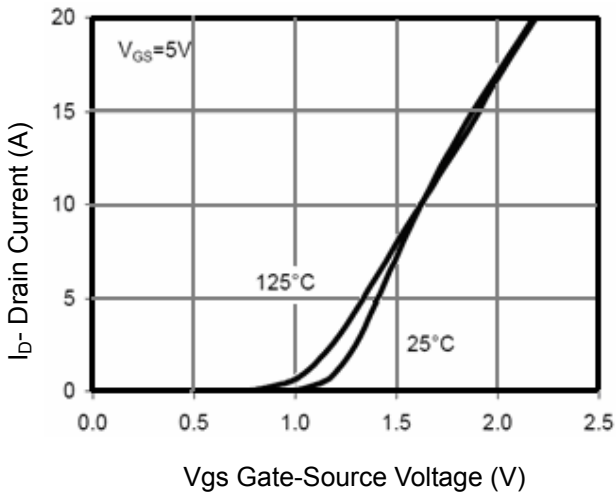
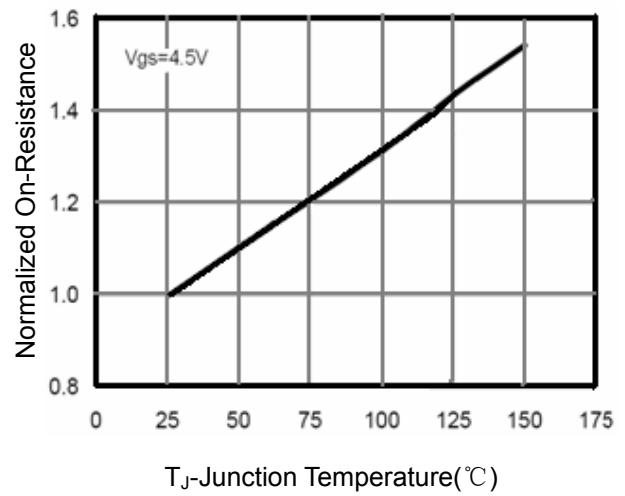
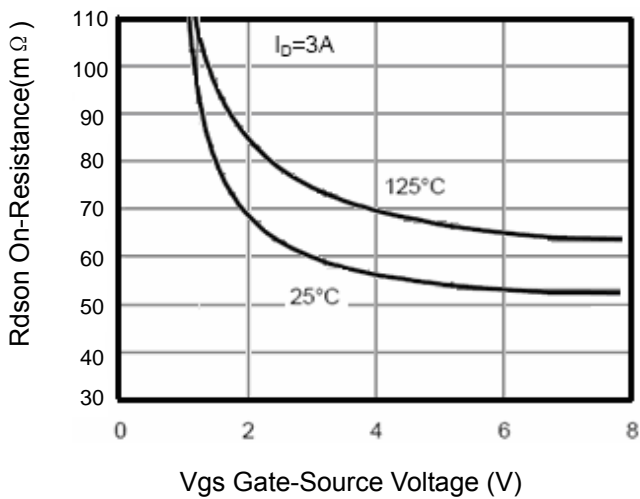
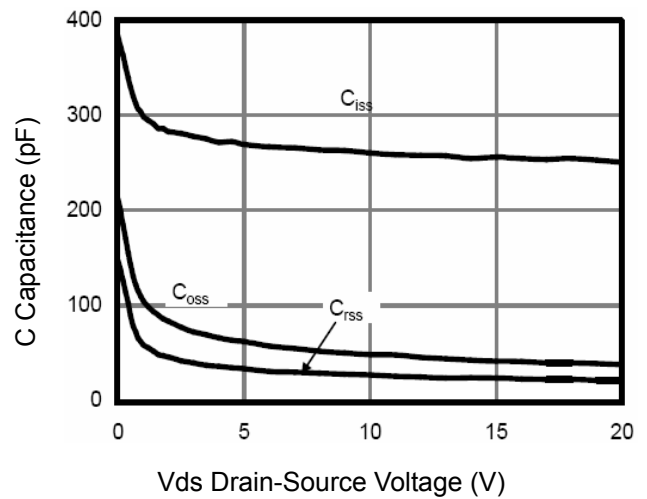
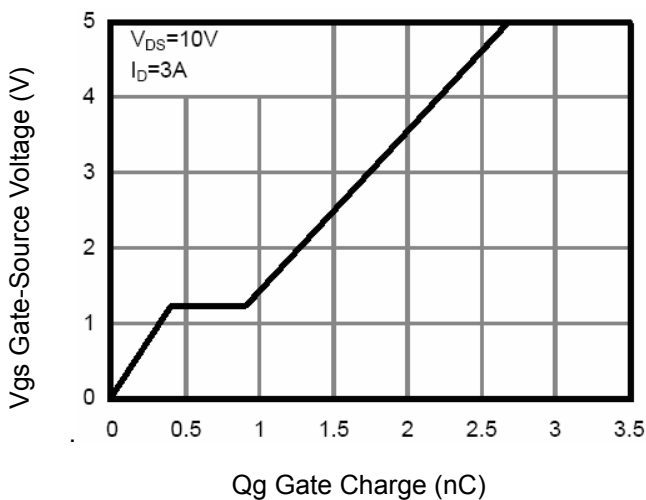
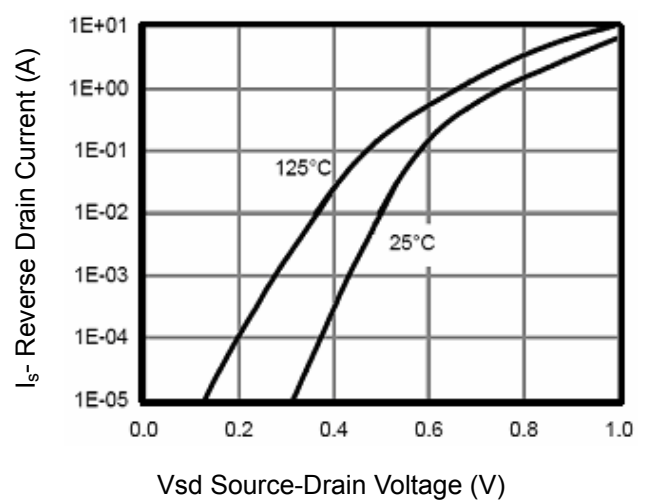
**Figure 1: Switching Test Circuit**

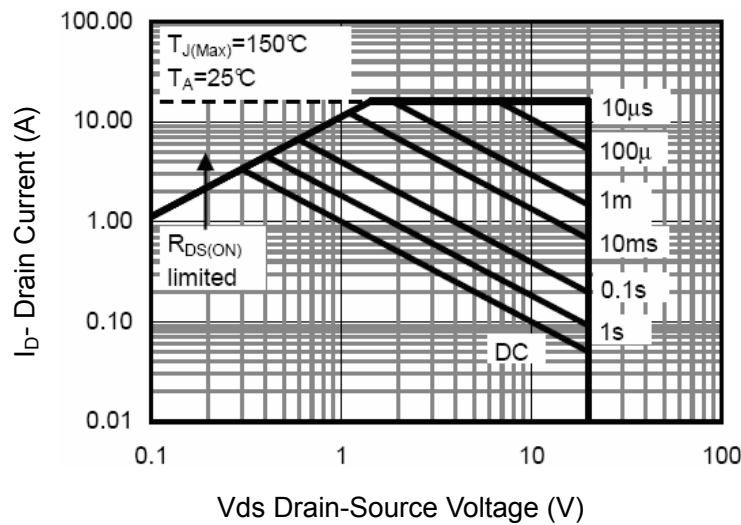
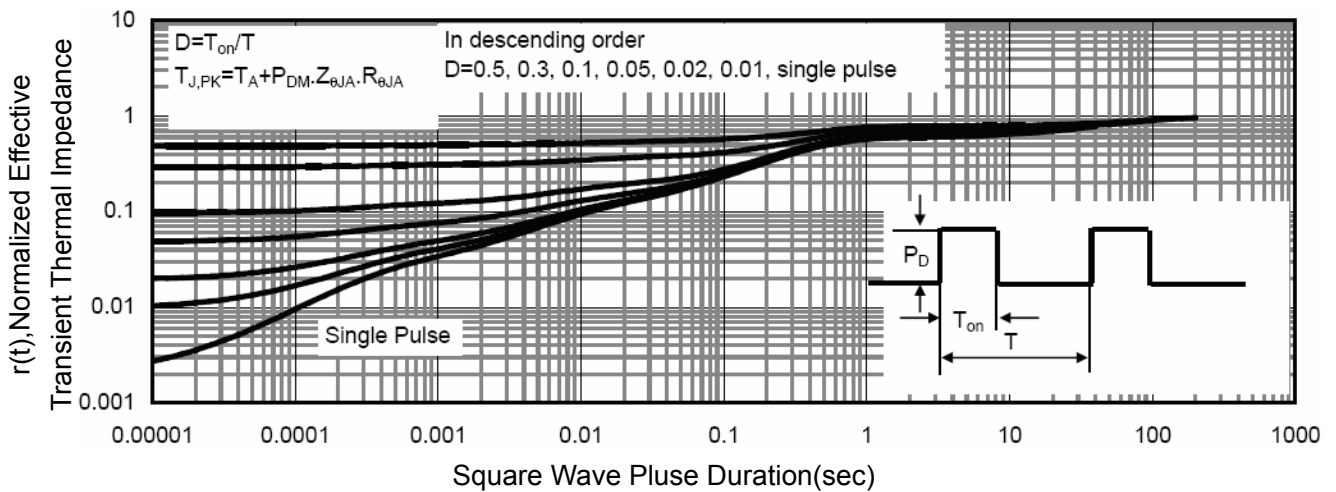
**Figure 2: Switching Waveforms**

**Figure 3 Power Dissipation**

**Figure 4 Drain Current**

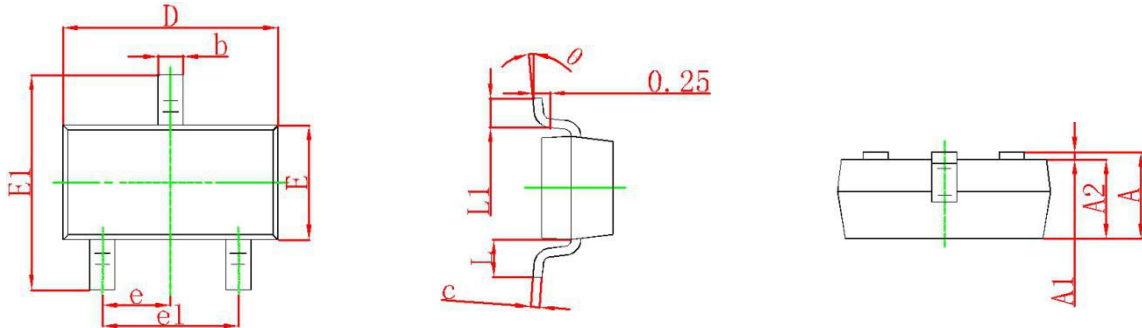
**Figure 5 Output Characteristics**

**Figure 6 Drain-Source On-Resistance**

**Figure 7 Transfer Characteristics**

**Figure 8 Drain-Source On-Resistance**

**Figure 9 Rdson vs Vgs**

**Figure 10 Capacitance vs Vds**

**Figure 11 Gate Charge**

**Figure 12 Source- Drain Diode Forward**

**Figure 13 Safe Operation Area**

**Figure 14 Normalized Maximum Transient Thermal Impedance**

# SI2302

## SOT-23 Package Outline Dimensions



Symbol	Dimensions In Millimeters		Dimensions In Inches	
	Min	Max	Min	Max
A	0.900	1.150	0.035	0.045
A1	0.000	0.100	0.000	0.004
A2	0.900	1.050	0.035	0.041
b	0.300	0.500	0.012	0.020
c	0.080	0.150	0.003	0.006
D	2.800	3.000	0.110	0.118
E	1.200	1.400	0.047	0.055
E1	2.250	2.550	0.089	0.100
e	0.950 TYP		0.037 TYP	
e1	1.800	2.000	0.071	0.079
L	0.550 REF		0.022 REF	
L1	0.300	0.500	0.012	0.020
θ	0°	8°	0°	8°

## SOT-23 Suggested Pad Layout

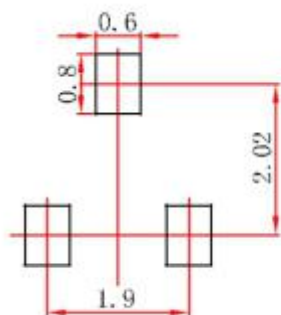

**Note:**

1. Controlling dimension: in millimeters.
2. General tolerance:  $\pm 0.05\text{mm}$ .
3. The pad layout is for reference purposes only.