

PCB VIEWING HOLES
DETAIL A
SCALE 5:1

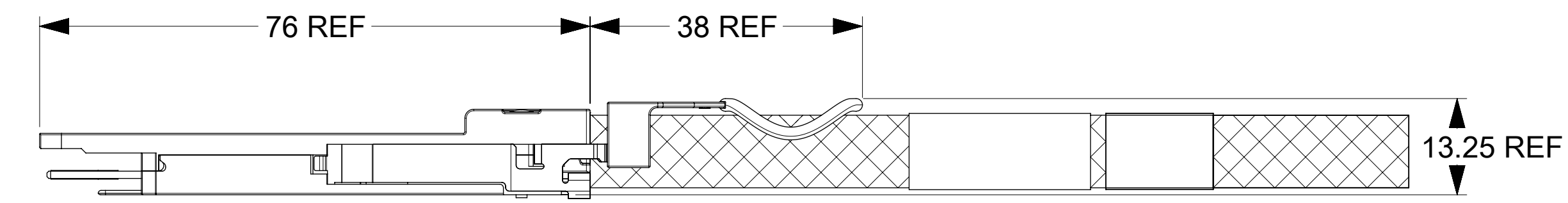
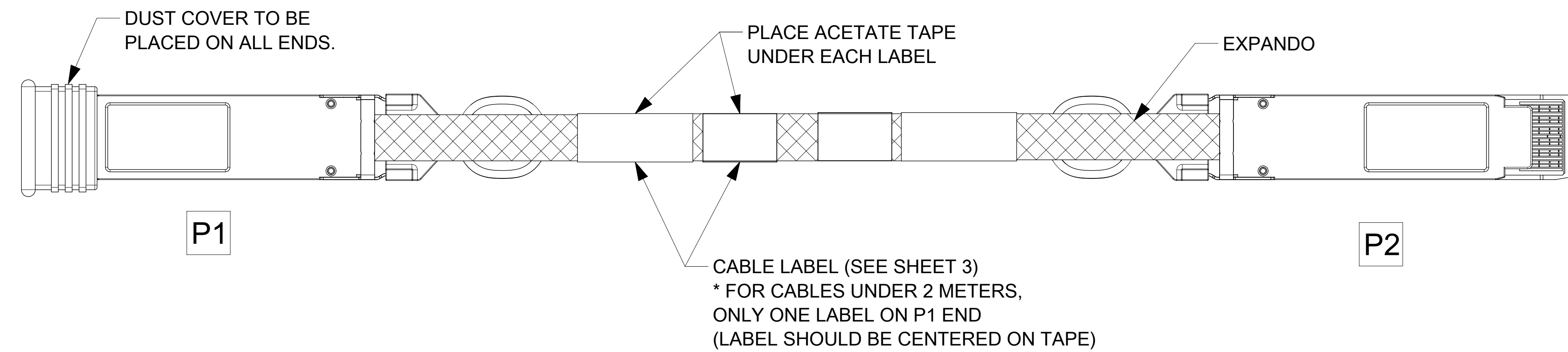

- NOTES:
- CABLE LENGTH DEPENDS ON WIRE GAUGE, DATA RATE, AND HOST BOARD DRIVER CAPABILITIES
 - MATERIALS:
 - BACKSHELLS - ZINC DIE CAST WITH BRIGHT NICKEL PLATING
 - DELATCH - STAINLESS STEEL WITH OVERMOLDED NYLON
 - RIVETS - STAINLESS STEEL
 - IMPEDANCE - 100 OHMS DIFFERENTIAL
 - BUNDLED CABLE RATED UL VW-1 FLAME PER UL STYLE 21479
 - EEPROM MAP AVAILABLE UPON REQUEST
 - RoHS COMPLIANT, NO EXEMPTIONS

FUNCTIONAL SYMBOLS $F_A = 0$ $F_C = 0$ $F_P = 0$ DIVISIONAL SYMBOLS	THIS DRAWING CONTAINS INFORMATION THAT IS PROPRIETARY TO MOLEX ELECTRONIC TECHNOLOGIES, LLC AND SHOULD NOT BE USED WITHOUT WRITTEN PERMISSION		CURRENT REV DESC: SHEET4 : ADDED LENGTH 2M 30AWG IN P/N TABLE		
	DIMENSION UNITS	SCALE	GENERAL TOLERANCES (UNLESS SPECIFIED)		
	mm	2:1	ANGULAR TOL ± 5.0°		
	4 PLACES ±		3 PLACES ±		
2 PLACES ± 0.13		1 PLACE ± 0.25		EC NO: 677116	
0 PLACES ±		DRAFT WHERE APPLICABLE MUST REMAIN WITHIN DIMENSIONS		DRWN: ADITHK 2021/05/24	
THIRD ANGLE PROJECTION		DRAWING		SERIES	
		D-SIZE		201591	
MATERIAL NUMBER		CUSTOMER		SHEET NUMBER	
SEE P/N TABLE		GENERAL MARKET		1 OF 4	

DOCUMENT STATUS	P1	RELEASE DATE	2021/09/10	01:01:00
-----------------	----	--------------	------------	----------

CABLE BEND RADIUS

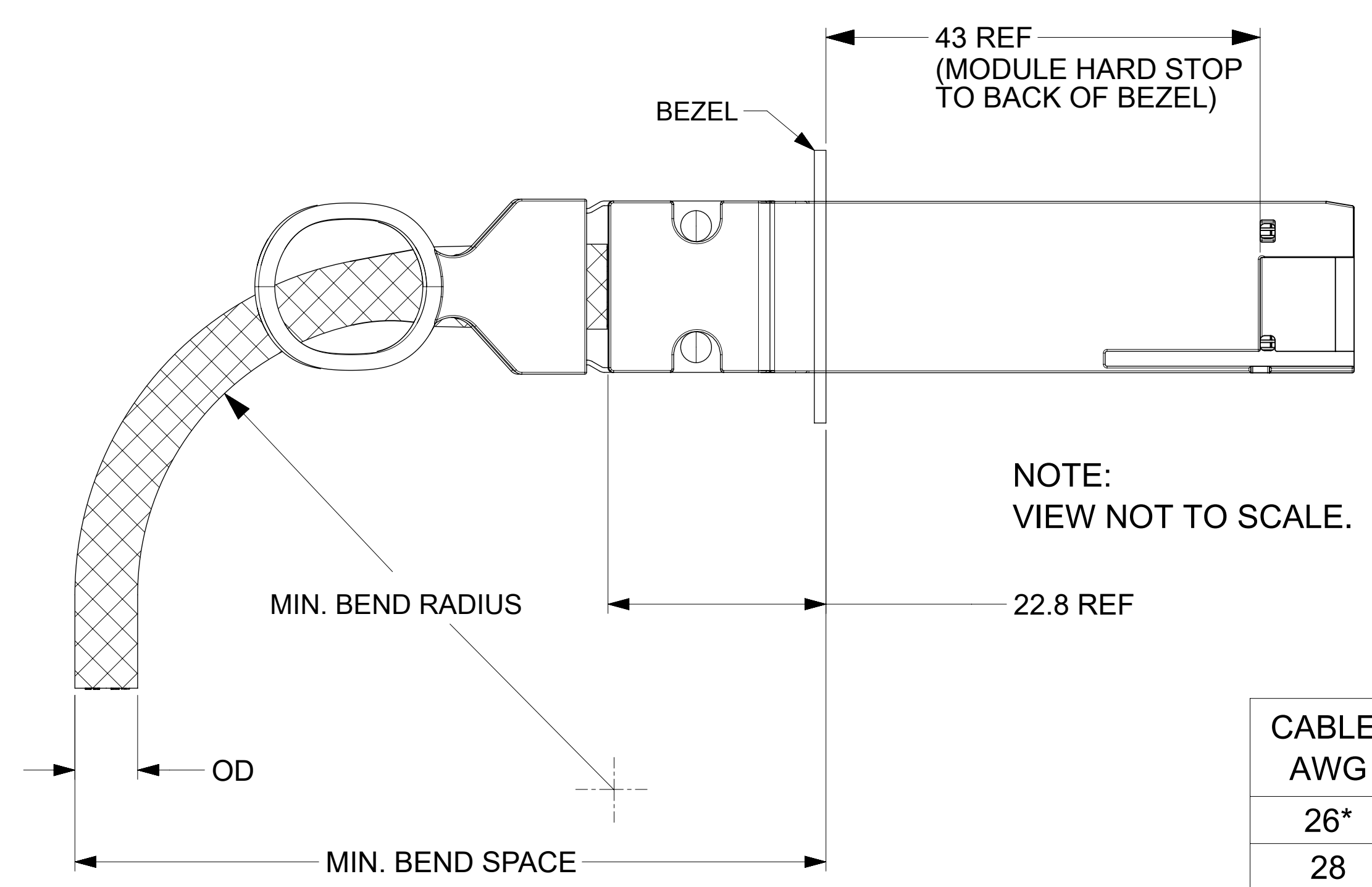

NOTE:
VIEW NOT TO SCALE.

CABLE AWG	OD (mm)	MIN BEND RADIUS (mm)	MIN BEND SPACE (mm)
26*	(13)	(65)	(101)
28	(11)	(55)	(89)
30	(9.4)	(45)	(77)

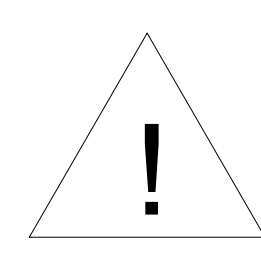

*MINIMUM BEND RADIUS PENDING QUALIFICATION. NUMBERS ABOVE ARE ESTIMATES AND SUBJECT TO CHANGE.

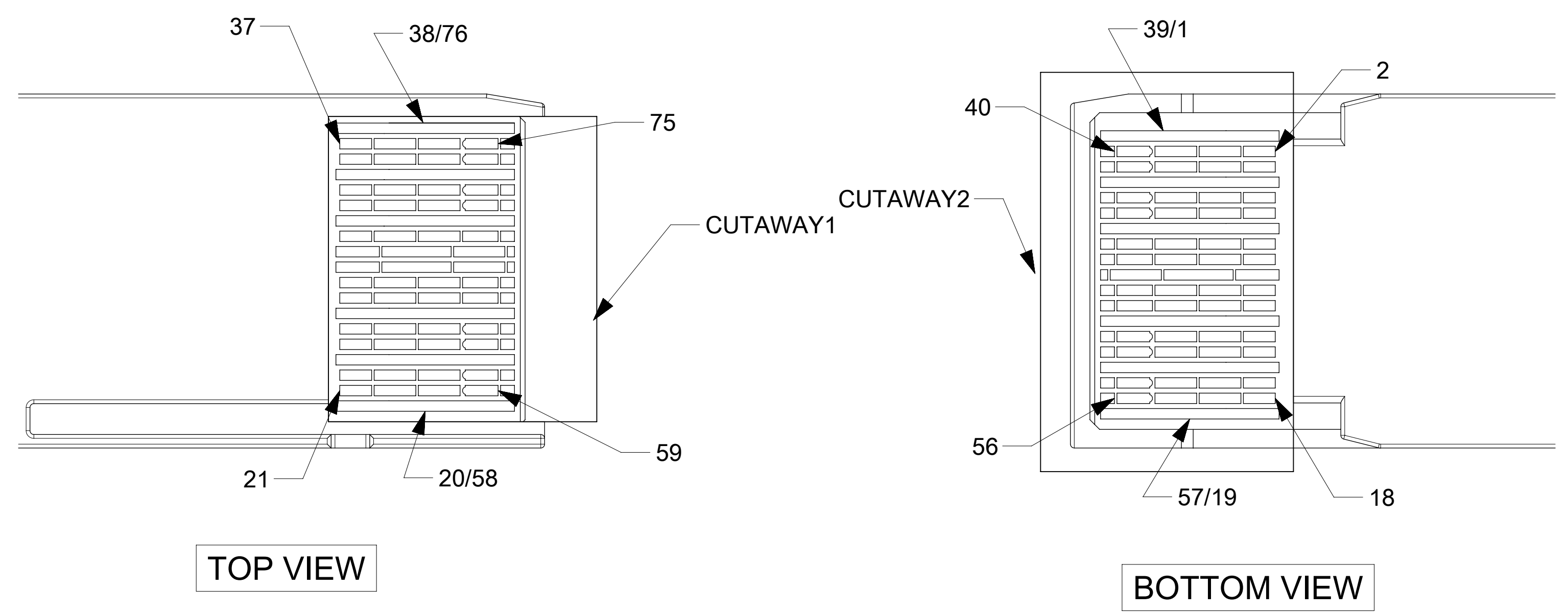

- NOTES:
- DC BLOCKING CAPS ON RECEIVE SIDE ONLY
 - CABLE COILED AND PACKAGED IN BEST FIT ESD BAG AND SEALED WITH ESD LABEL FOR SHIPPING

FUNCTIONAL SYMBOLS $F_A = 0$ $F_C = 0$ $F_P = 0$	DIMENSION UNITS: mm SCALE: 20:1		CURRENT REV DESC: SHEET4 : ADDED LENGTH 2M 30AWG IN P/N TABLE				
	GENERAL TOLERANCES (UNLESS SPECIFIED)		EC NO: 677116 DRWN: ADITHK 2021/05/24 CHK'D: VITTAD 2021/09/09 APPR: MGARRISON 2021/09/10			PRODUCT CUSTOMER DRAWING	
	ANGULAR TOL $\pm 5.0^\circ$		INITIAL REVISION: DRWN: TPRATT 2016/11/08 APPR: CHIRSCHY 2016/11/10				DOCUMENT NUMBER: 2015911005
	DRAFT WHERE APPLICABLE MUST REMAIN WITHIN DIMENSIONS		THIRD ANGLE PROJECTION	DRAWING: D-SIZE		SERIES: 201591	MATERIAL NUMBER: SEE P/N TABLE

WIRING DIAGRAM

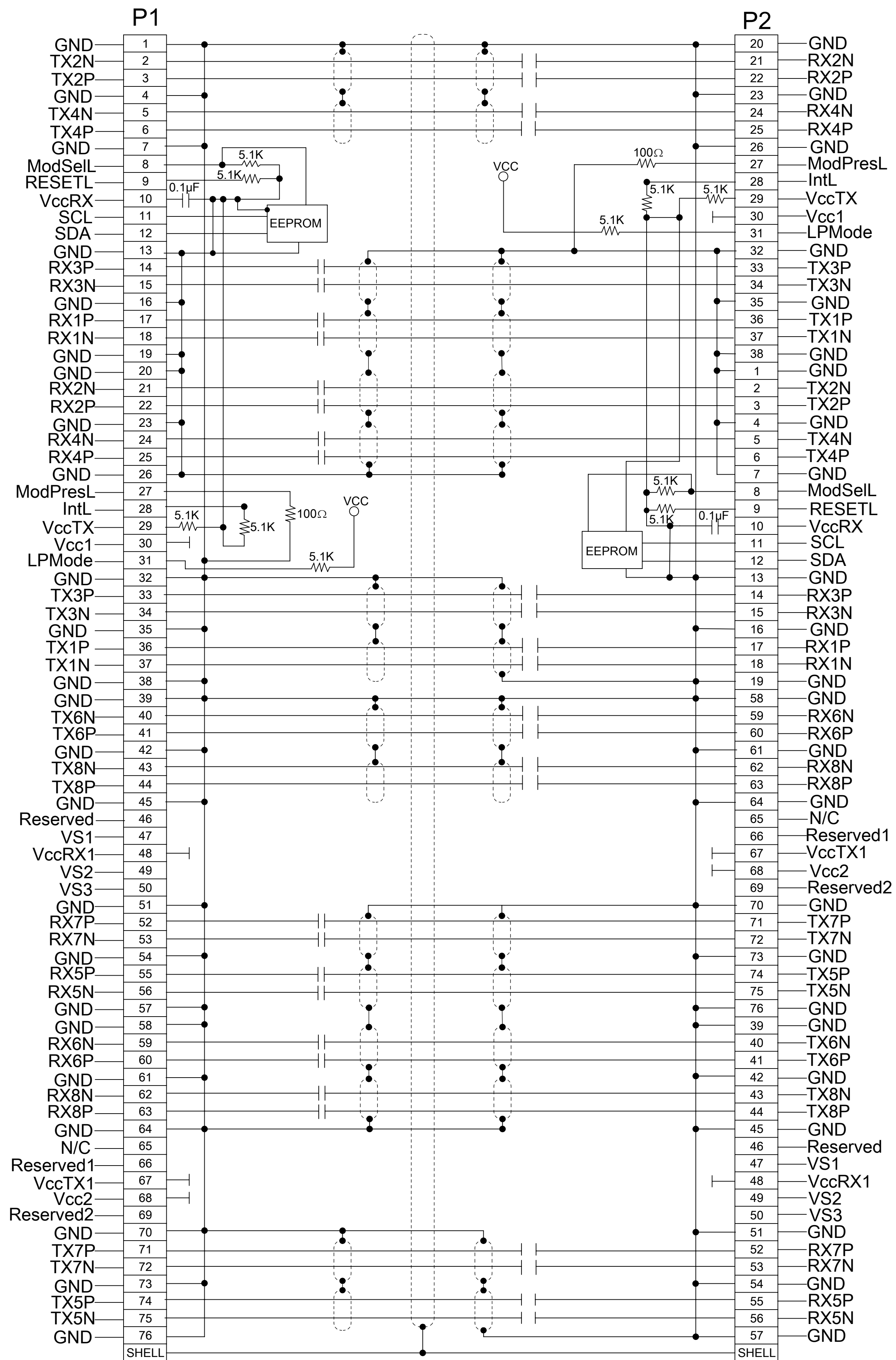

FUNCTIONAL SYMBOLS	THIS DRAWING CONTAINS INFORMATION THAT IS PROPRIETARY TO MOLEX ELECTRONIC TECHNOLOGIES, LLC AND SHOULD NOT BE USED WITHOUT WRITTEN PERMISSION		CURRENT REV DESC: SHEET4 : ADDED LENGTH 2M 30AWG IN P/N TABLE		<h1 style="margin: 0;">molex</h1>
	DIMENSION UNITS	SCALE			
$\nabla_A = 0$	mm	1:1			QSFP-DD TO QSFP-DD 56G PASSIVE CABLE ASY
$\nabla_C = 0$	GENERAL TOLERANCES (UNLESS SPECIFIED)				
$\nabla_P = 0$	ANGULAR TOL $\pm 5.0^\circ$				PRODUCT CUSTOMER DRAWING
DIVISIONAL SYMBOLS	4 PLACES	\pm	EC NO: 677116		
	3 PLACES	\pm	DRWN: ADITHK 2021/05/24		
	2 PLACES	± 0.13	CHK'D: VITTAD 2021/09/09		
	1 PLACE	± 0.25	APPR: MGARRISON 2021/09/10		
	0 PLACES	\pm	INITIAL REVISION:		
	DRAFT WHERE APPLICABLE MUST REMAIN WITHIN DIMENSIONS		DRWN: TPRATT 2016/11/08		DOCUMENT NUMBER 2015911005
	THIRD ANGLE PROJECTION		APPR: CHIRSCHY 2016/11/10		
	DRAWING		SERIES		DOC PART 000
	D-SIZE		201591		REVISION U
	SEE P/N TABLE		GENERAL MARKET		SHEET NUMBER 3 OF 4

LABEL DETAILS

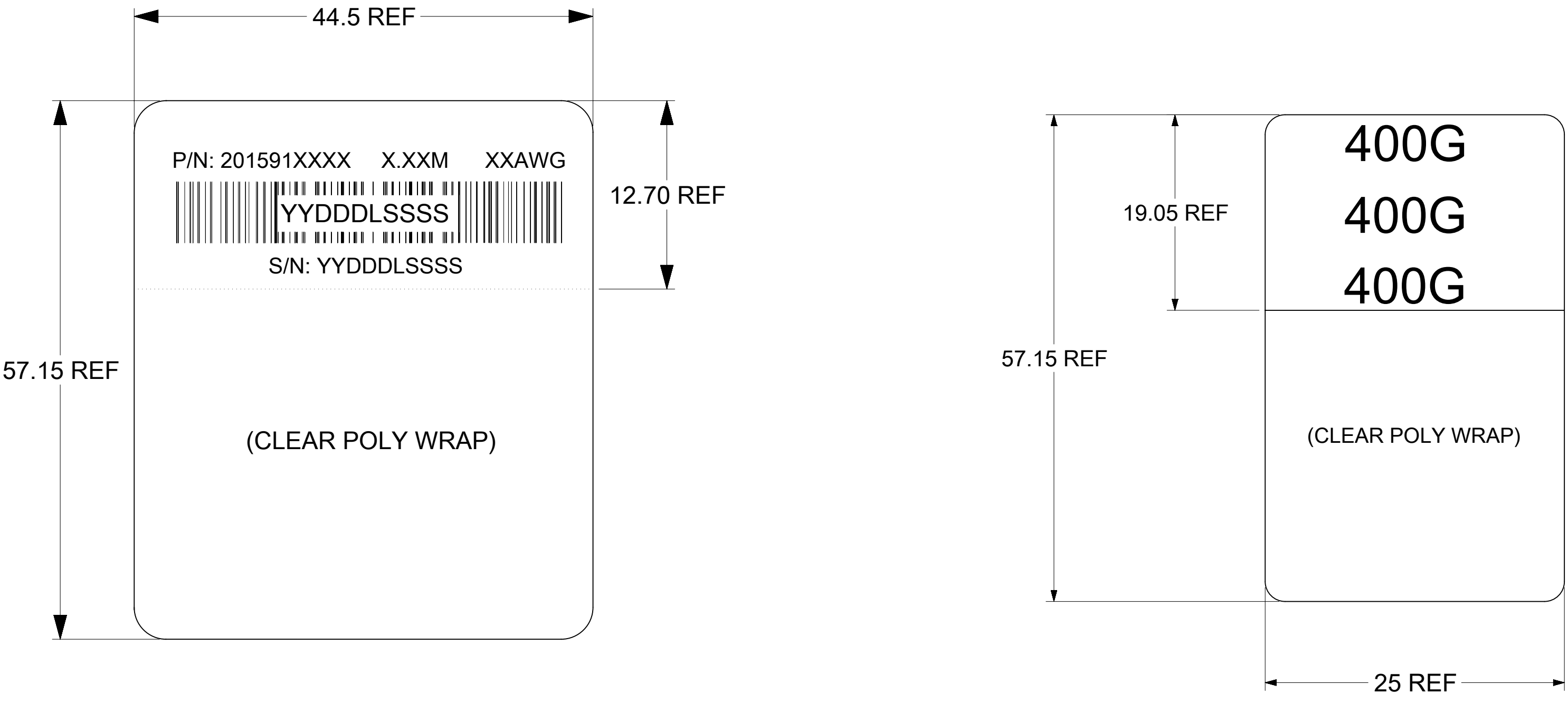

P/N: 201591XXXX - MOLEX PART NUMBER (SEE P/N TABLE)

X.XXM - CABLE LENGTH IN METERS (EXAMPLES - 0.5M, 1.0M, 1.5M)
SEE P/N TABLE FOR THE NUMBER OF DIGITS

XXAWG - CABLE SIZE IN AWG

S/N: YYDDLSSSS - SERIAL NUMBER
 YY = YEAR, THE LAST 2 DIGITS OF YEAR
 DDD = DAY OF THE YEAR
 L = LOCATION
 1 - USA
 2 - MEXICO
 3 - CHINA
 4 - PHILIPPINES
 SSSS = SERIAL NUMBER (0001-9999)

MOLEX P/N	LENGTH (M)	AWG
2015911005*	0.5M +/- 0.05M	30
2015911007	0.75M +/- 0.05M	30
2015911010	1.0M +/- 0.05M	30
2015911012	1.25M +/- 0.05M	30
2015911015	1.5M +/- 0.08M	30
2015911020	2.0M +/- 0.08M	30
2015913005*	0.5M +/- 0.05M	28
2015913010	1.0M +/- 0.05M	28
2015913012	1.25M +/- 0.05M	28
2015913015	1.5M +/- 0.08M	28
2015913017	1.75M +/- 0.08M	28
2015913020	2.0M +/- 0.08M	28
2015913025	2.5M +/- 0.08M	28
2015913252	2.5M +/- 0.08M	26
2015913027	2.75M +/- 0.08M	26
2015913030	3.0M +/- 0.08M	26

*CABLES MAY NOT MEET ALL IEEE 802.3cd 56G PAM4 PARAMETERS

FUNCTIONAL SYMBOLS $\nabla_A = 0$ $\nabla_C = 0$ $\nabla_P = 0$ DIVISIONAL SYMBOLS	THIS DRAWING CONTAINS INFORMATION THAT IS PROPRIETARY TO MOLEX ELECTRONIC TECHNOLOGIES, LLC AND SHOULD NOT BE USED WITHOUT WRITTEN PERMISSION		CURRENT REV DESC: SHEET4 : ADDED LENGTH 2M 30AWG IN P/N TABLE		
	DIMENSION UNITS	SCALE	GENERAL TOLERANCES (UNLESS SPECIFIED)		
	mm	1:1	ANGULAR TOL $\pm 5.0^\circ$		
	DRAFT WHERE APPLICABLE MUST REMAIN WITHIN DIMENSIONS		THIRD ANGLE PROJECTION		
EC NO: 677116		DRWN: ADITHK 2021/05/24		PRODUCT CUSTOMER DRAWING	
4 PLACES \pm		CHK'D: VITTAD 2021/09/09		DOCUMENT NUMBER	
3 PLACES \pm		APPR: MGARRISON 2021/09/10		DOC TYPE	
2 PLACES ± 0.13		INITIAL REVISION:		DOC PART	
1 PLACE ± 0.25		DRWN: TPRATT 2016/11/08		REVISION	
0 PLACES \pm		APPR: CHIRSCHY 2016/11/10		2015911005	
D-D-SIZE		SERIES		PSD	
D-D-SIZE		201591		000	
SEE P/N TABLE		GENERAL MARKET		U	
SHEET NUMBER		4 OF 4			