

**SP5001 Series 4 Channel TVS Common Mode Filter**

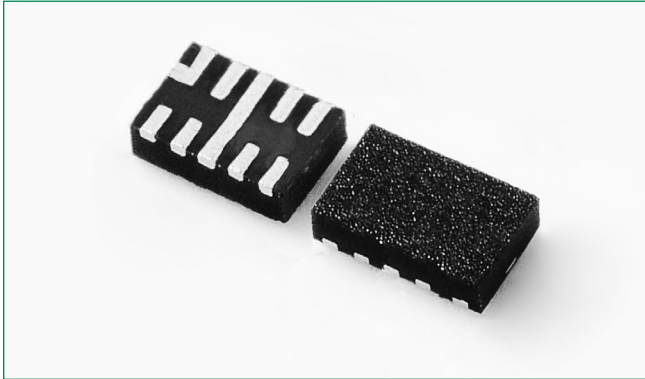

**OBSOLETE** DATE: 12/31/2022 PCN/ECN# ESU270-77  
REPLACED BY: NA



**Description**

The SP5001 Series is a highly integrated Common Mode Filter (CMF) providing both ESD protection and EMI common mode noise filtering for systems using high speed differential serial interfaces, such as MIPI D-PHY or HDMI.

The SP5001 Series can protect and filter two differential line pairs in a small RoHS-compliant TDFN-10 package, with cost and space savings over discrete solutions.

**Pinout**

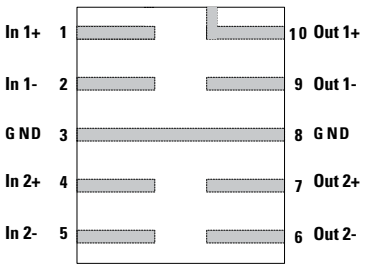

Note :This drawing is not to scale.

**Features**

- Large differential bandwidth > 2.5 GHz
- High Common Mode Stop Band Attenuation:
  - > 25 dB at 700 MHz
  - > 30 dB at 800 MHz
- ±15kV ESD protection per channel (IEC 61000-4-2 Level 4, contact discharge and ±30kV air discharge)
- TDFN-10 2.50mm × 2.00mm × 0.75mm package with 0.50mm lead pitch
- RoHS-compliant, Lead-free packaging
- Moisture Sensitivity Level (MSL-1)

**Functional Block Diagram**

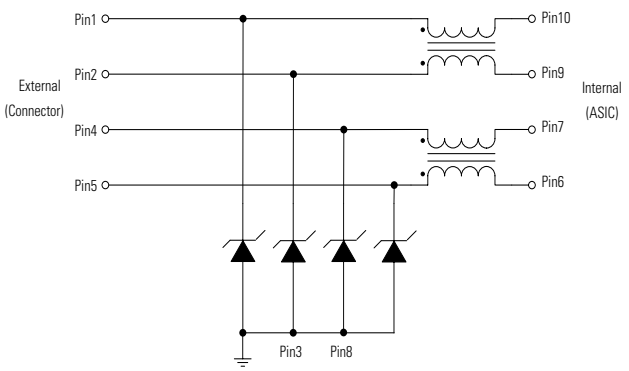

**Applications**

- HDMI/DVI Display in Mobile Phones
- MIPI D-PHY (CSI-2, DSI, etc) in Mobile Phones and Digital Still Cameras

**Absolute Maximum Ratings**

Symbol	Parameter	Value	Units
$I_{DC}$	DC Current Per Line	100	mA
$P_{DC}$	DC Package Power Rating	0.5	W
$T_{OP}$	Operating Temperature	-40 to 125	°C
$T_{STOR}$	Storage Temperature	-55 to 150	°C

**CAUTION:** Stresses above those listed in "Absolute Maximum Ratings" may cause permanent damage to the component. This is a stress only rating and operation of the component at these or any other conditions above those indicated in the operational sections of this specification is not implied.

**Electrical Characteristics ( $T_{OP}=25^{\circ}C$ )**

Parameter	Symbol	Test Conditions	Min	Typ	Max	Units
Channel Resistance	$R_{CH}$	Pins 1-10, 2-9, 4-7 and 5-6		8.0		$\Omega$
Total Channel Capacitance	$C_{TOTAL}$	$V_{I/O} = 1.65V_{DC}$ Reverse Bias; $f=1MHz, 30mV_{AC}$		0.8	1.3	pF
Reverse Standoff Voltage	$V_{RWM}$				5.0	V
Breakdown Voltage	$V_{BR}$	$I_T=1mA$	6.0	8.0	10.0	V
Forward Voltage at $I_F$	$V_F$	$I_F=1mA$	0.4	0.7	1.5	V
Reverse Leakage Current	$I_{LEAK}$	$V_{I/O} = 3.3V$		0.01	0.10	$\mu A$
Dynamic Resistance <sup>2 3</sup>	$R_{DYN}$	Positive ( $t_p=8/20\mu s$ )		1.3		$\Omega$
		Negative ( $t_p=8/20\mu s$ )		0.7		
		TLP, $t_p=100ns, I/O$ to GND		0.36		
ESD Withstand Voltage <sup>1 2</sup>	$V_{ESD}$	IEC 61000-4-2 (Contact Discharge)	$\pm 15$			kV
		IEC 61000-4-2 (Air Discharge)	$\pm 30$			kV
Differential Mode Cutoff Frequency <sup>2</sup>	$F_{3dB}$	$Z_{SOURCE}=50 \Omega, Z_{LOAD} 50 \Omega$		2.5		GHz
Common Mode Stop Band Attenuation <sup>2</sup>	$F_{\alpha}$	$f=800MHz$		30		dB

**Notes:**

- ESD zapping at I/O pins (1,2,4,5) with respect to GND.
- Guaranteed by design.
- Transmission Line Pulse (TLP) with 100ns width and 200ps rise time.

**Differential Mode Attenuation SDD21 vs. Frequency ( $Z_{diff} = 100\Omega$ )**

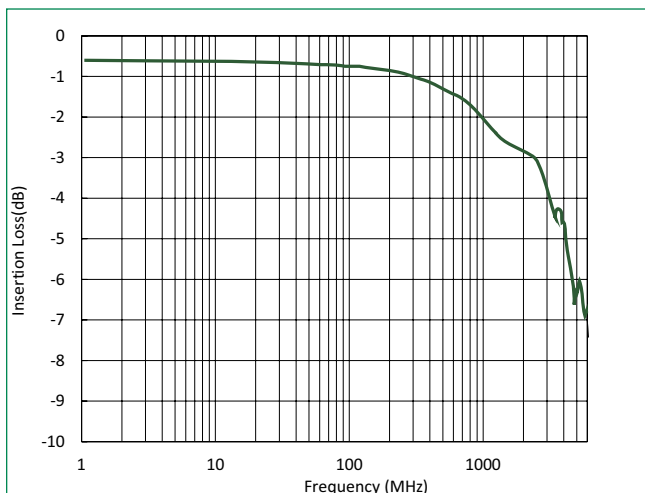

**Common Mode Attenuation SCC21 vs. Frequency ( $Z_{comm} = 50\Omega$ )**

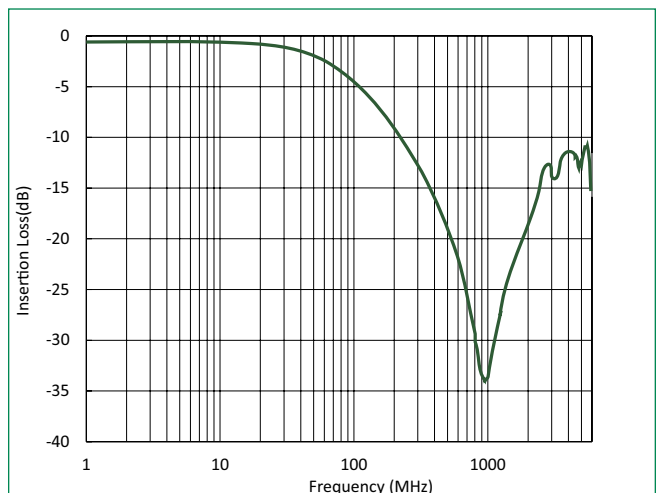

**Differential Return Loss SDD11 vs. Frequency (Zdiff = 100Ω)**

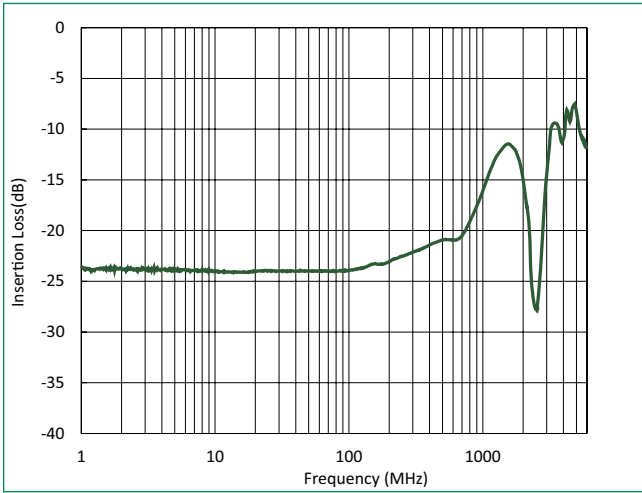

**Differential Return Loss SDD22 vs. Frequency (Zdiff = 100Ω)**

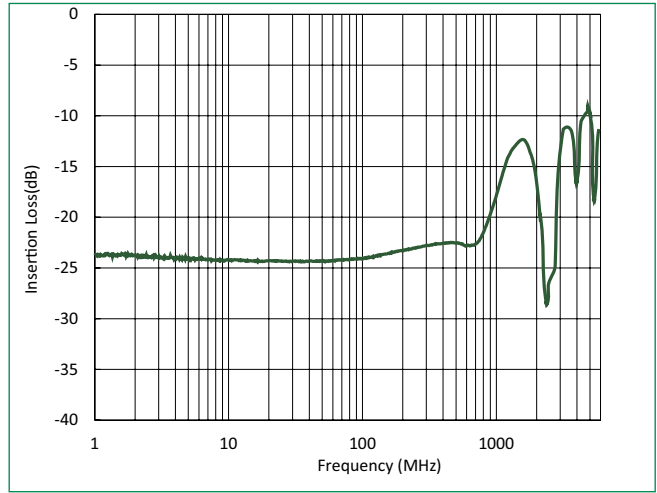

**Transmission Line Pulsing (TLP) Plot**

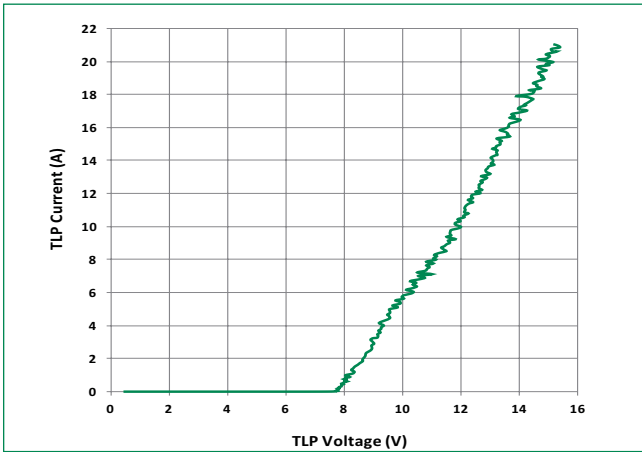

**Part Numbering System**

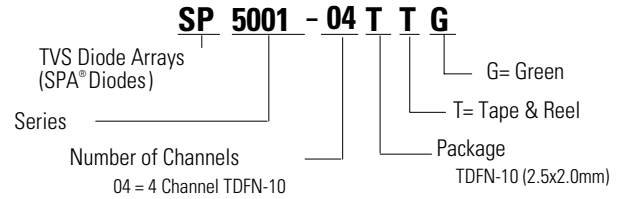

**Part Marking System**

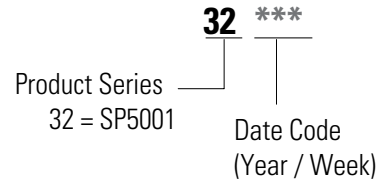

**Soldering Parameters**

<b>Reflow Condition</b>		Pb – Free assembly
<b>Pre Heat</b>	- Temperature Min ( $T_{s(min)}$ )	150°C
	- Temperature Max ( $T_{s(max)}$ )	200°C
	- Time (min to max) ( $t_s$ )	60 – 180 secs
<b>Average ramp up rate (Liquidus) Temp (<math>T_L</math>) to peak</b>		3°C/second max
<b><math>T_{S(max)}</math> to <math>T_L</math> - Ramp-up Rate</b>		3°C/second max
<b>Reflow</b>	- Temperature ( $T_L$ ) (Liquidus)	217°C
	- Temperature ( $t_L$ )	60 – 150 seconds
<b>Peak Temperature (<math>T_p</math>)</b>		260 <sup>+0/-5</sup> °C
<b>Time within 5°C of actual peak Temperature (<math>t_p</math>)</b>		20 – 40 seconds
<b>Ramp-down Rate</b>		6°C/second max
<b>Time 25°C to peak Temperature (<math>T_p</math>)</b>		8 minutes Max.
<b>Do not exceed</b>		260°C

**Ordering Information**

Part Number	Package	Size	Min. Order Qty.
SP5001-04TTG	TDFN-10	2.5x2.0mm	3000

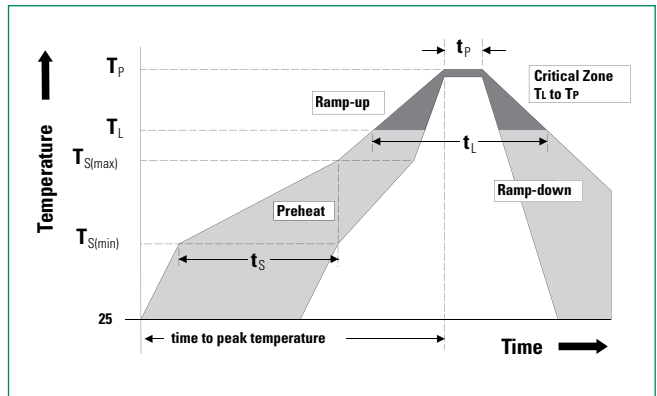

**Package Dimensions –TDFN-10**

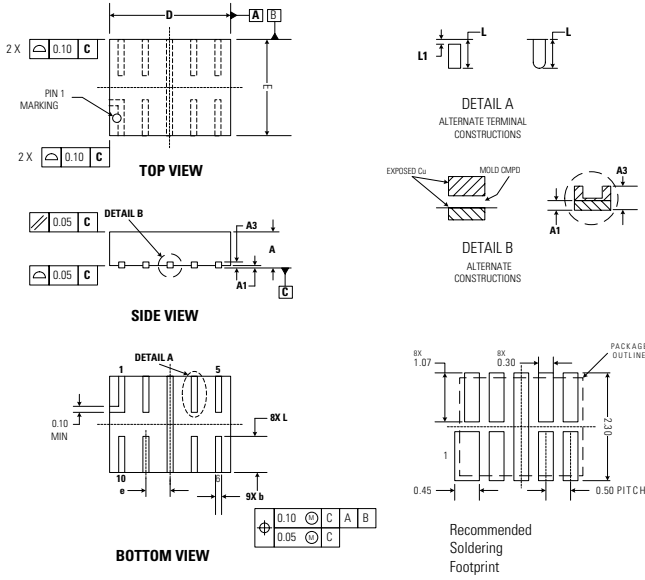

Symbol	TDFN-10			
	JEDEC MO-229			
	Millimeters		Inches	
	Min	Max	Min	Max
<b>A</b>	0.70	0.80	0.028	0.031
<b>A1</b>	0.00	0.05	0.000	0.002
<b>A3</b>	0.2 REF		0.008 REF	
<b>b</b>	0.15	0.25	0.006	0.010
<b>D</b>	2.50 BSC		0.098 BSC	
<b>E</b>	2.00 BSC		0.079 BSC	
<b>e</b>	0.50 BSC		0.020 BSC	
<b>L</b>	0.70	0.90	0.028	0.035
<b>L1</b>	0.05	0.15	0.002	0.006

**Tape & Reel Specification –TDFN-10**

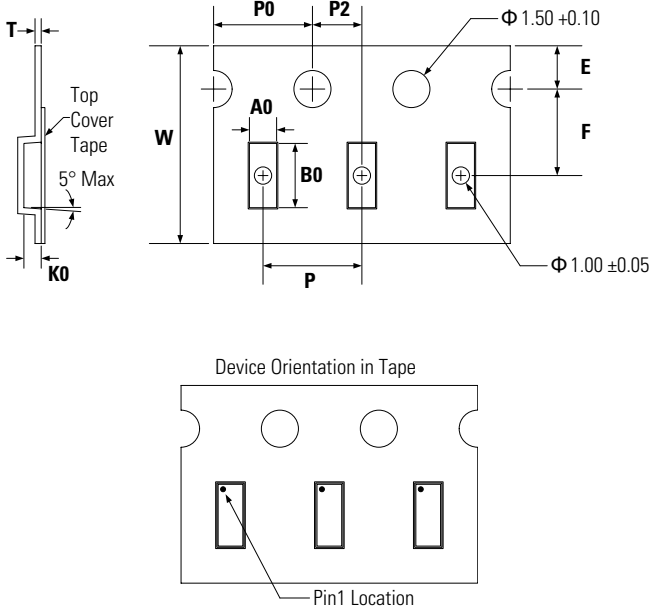

Symbol	Dimensions
	Millimetres
<b>E</b>	1.75 +/- 0.10
<b>F</b>	3.5 +/- 0.05
<b>P</b>	4.0 +/- 0.10
<b>P0</b>	4.0 +/- 0.10
<b>P2</b>	2.0 +/- 0.05
<b>W</b>	8.00 +0.30/- 0.10
<b>A0</b>	2.19 +/- 0.05
<b>B0</b>	2.77 +/- 0.05
<b>K0</b>	1.05 +/- 0.05
<b>T</b>	0.25 +/- 0.02