

REVISONS		DATE	DWN	APVD
A9	ECR-16-012681	05SEP2016	WW	RR
A10	ECR-17-001797	16FEB2017	LZ	RR
A11	ECR-17-009226	03JUL2017	LZ	RR

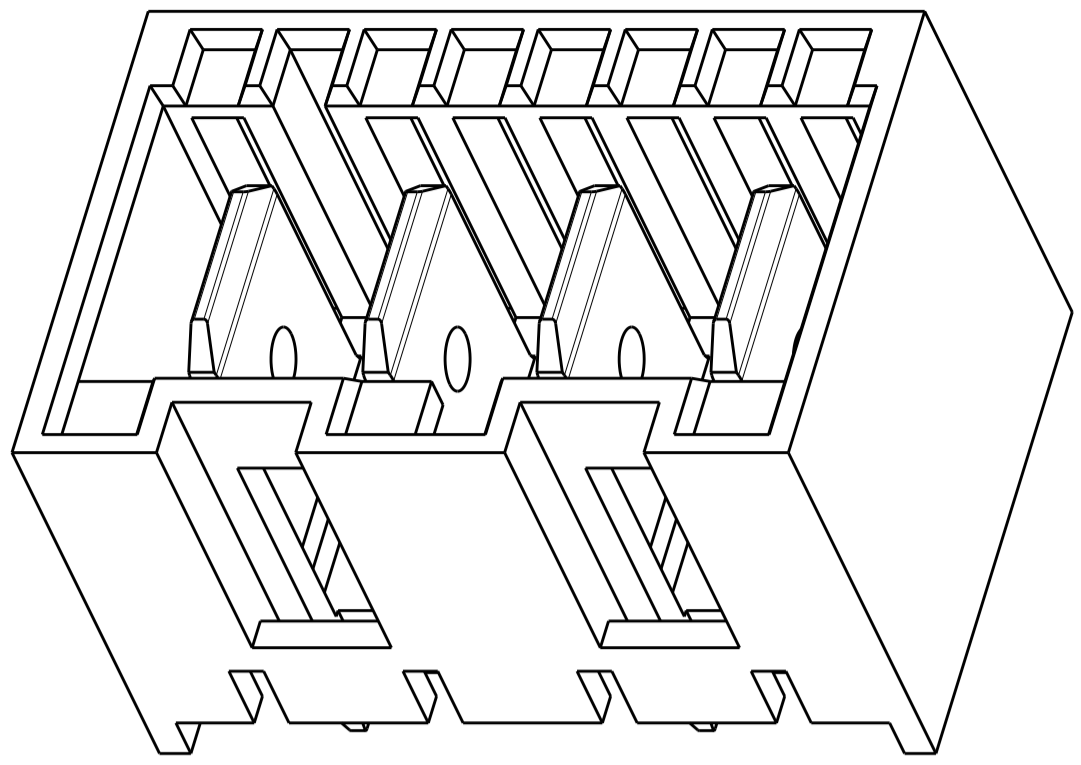

- NOTE
- HOUSING HAS RAST 5 COMPLIANT KEYING, LATCHING, AND POLARIZATION TAB IS 6.30 X 0.8 ACCORDING TO DIN 46244
  - SEE SHEET 2 FOR AVAILABLE CONFIGURATIONS
  - MATERIAL: HOUSING, NYLON, UL94 V0, 750°C GWT NO FLAME CONTACT, COPPER ALLOY, 0.8MM THICK
  - FINISH: CONTACTS, MATT TIN PLATING OVERALL, NICKEL UNDER-PLATING BRIGHT TIN PLATING OVERALL, NICKEL UNDER-PLATING SILVER PLATING OVERALL, NICKEL UNDER-PLATING
  - PCB TABS INSERTED IN A STAGGERED PATTERN BEGINNING WITH POSITION 1 (C<sub>c</sub>+1)
  - THE PART NUMBERS SHOWING IN SHEET 2 & 3 & 4 & 5 ARE FOR NATURAL COLOR. THE PART NUMBER FOR OTHER COLOR ARE BASED ON THE NATURAL ONE: FOR THE SAME CONFIGURATION, THE PREFIX AND POSTFIX OF THE P/N ARE THE SAME, ONLY THE BASE NUMBER IS DIFFERENT ACCORDING TO DIFFERENT COLOR, DETAIL PLEASE SEE SHEET 6
  - PACKAGING: LOOSE PIECE OR TUBE. THE PART NUMBERS IN THIS DRAWING ARE WITH LOOSE PIECE PACKAGING. PLEASE CONTACT TE SALES REPRESENTATIVES FOR TUBE PACKAGING REQUIREMENT.
- PRELIMINARY PART NOT RELEASED FOR PRODUCTION
- FOR P/N: 8-2232043-7:  
 1) THE CONTACTS ARE WITH BRIGHT TIN PLATING ACCORDING TO STANDARD:ASTM B 545.

- PART NUMBERS WITH TUBE PACKAGING
- PART WITHOUT POLARIZATION PEG STRUCTURE (FOR PN: 2316476-3)

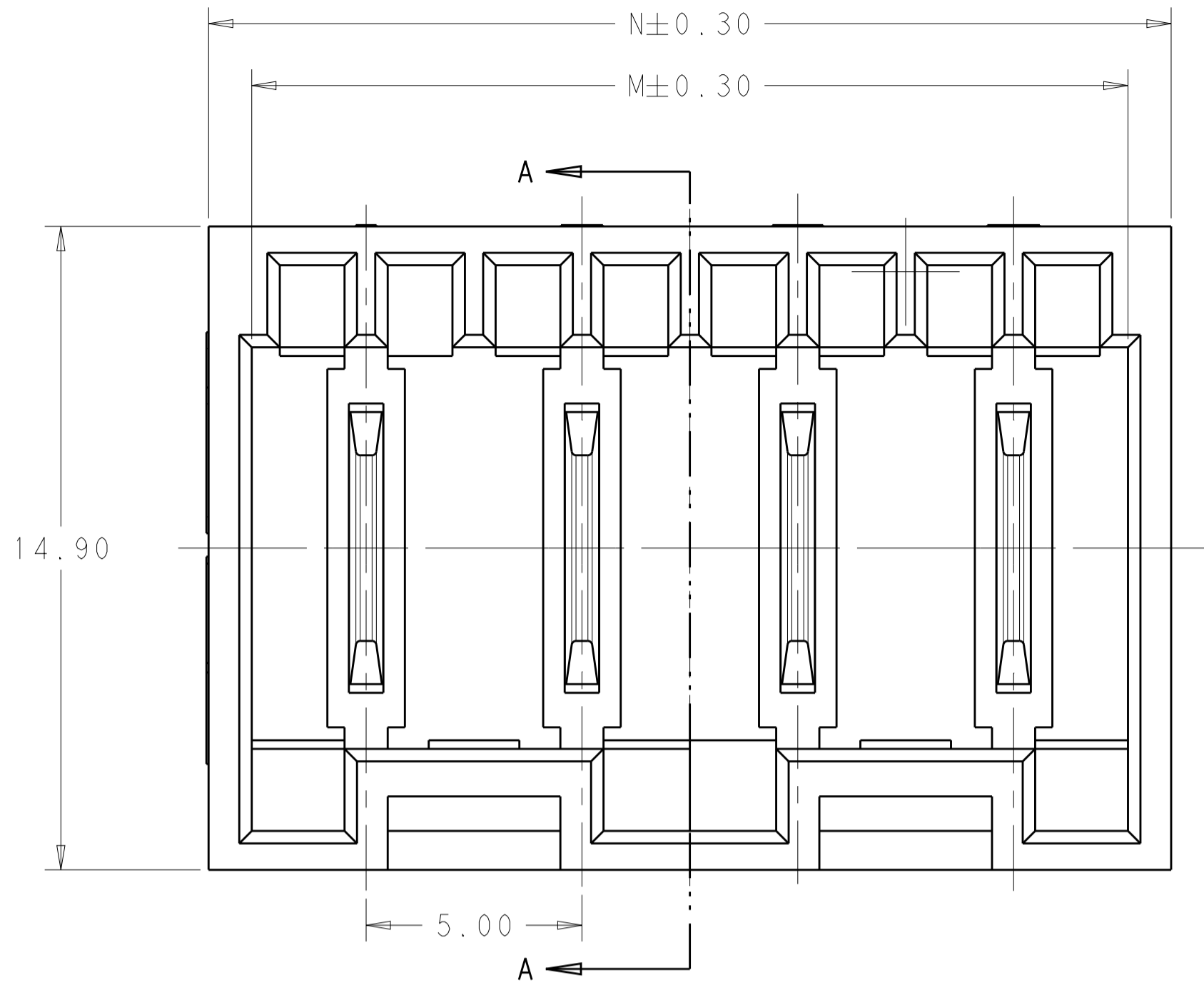
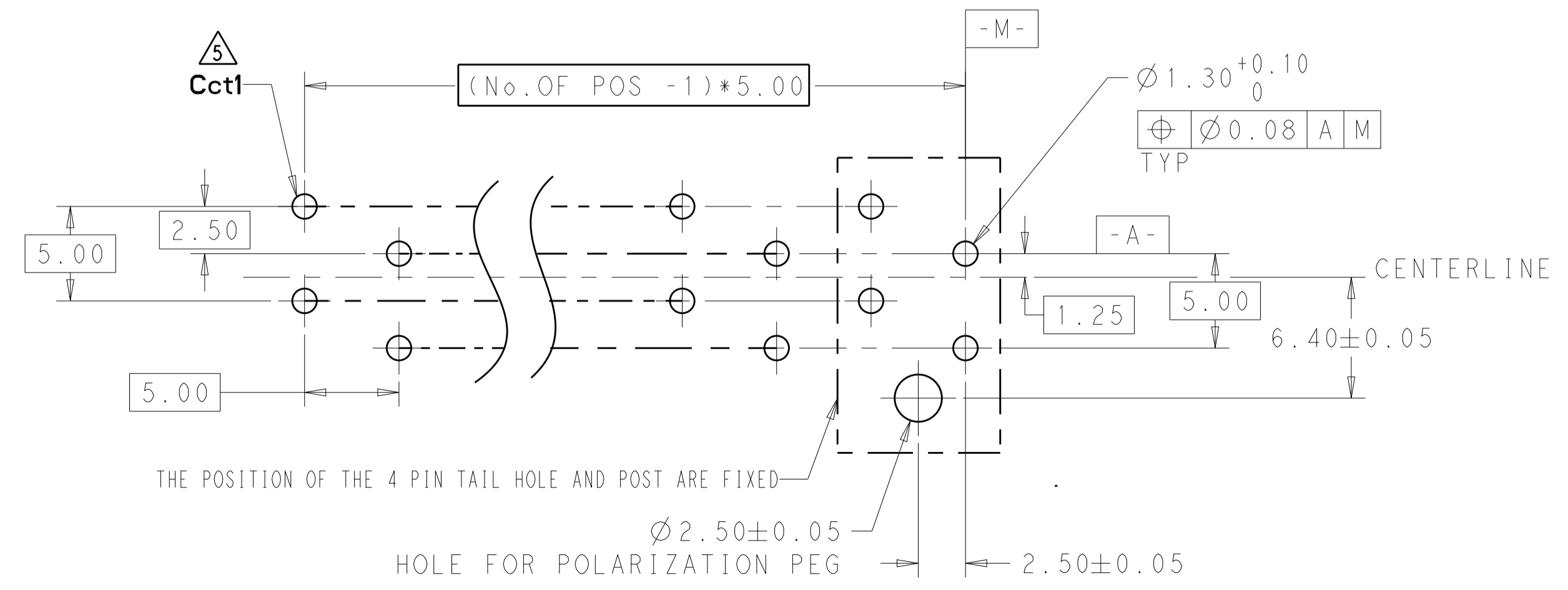
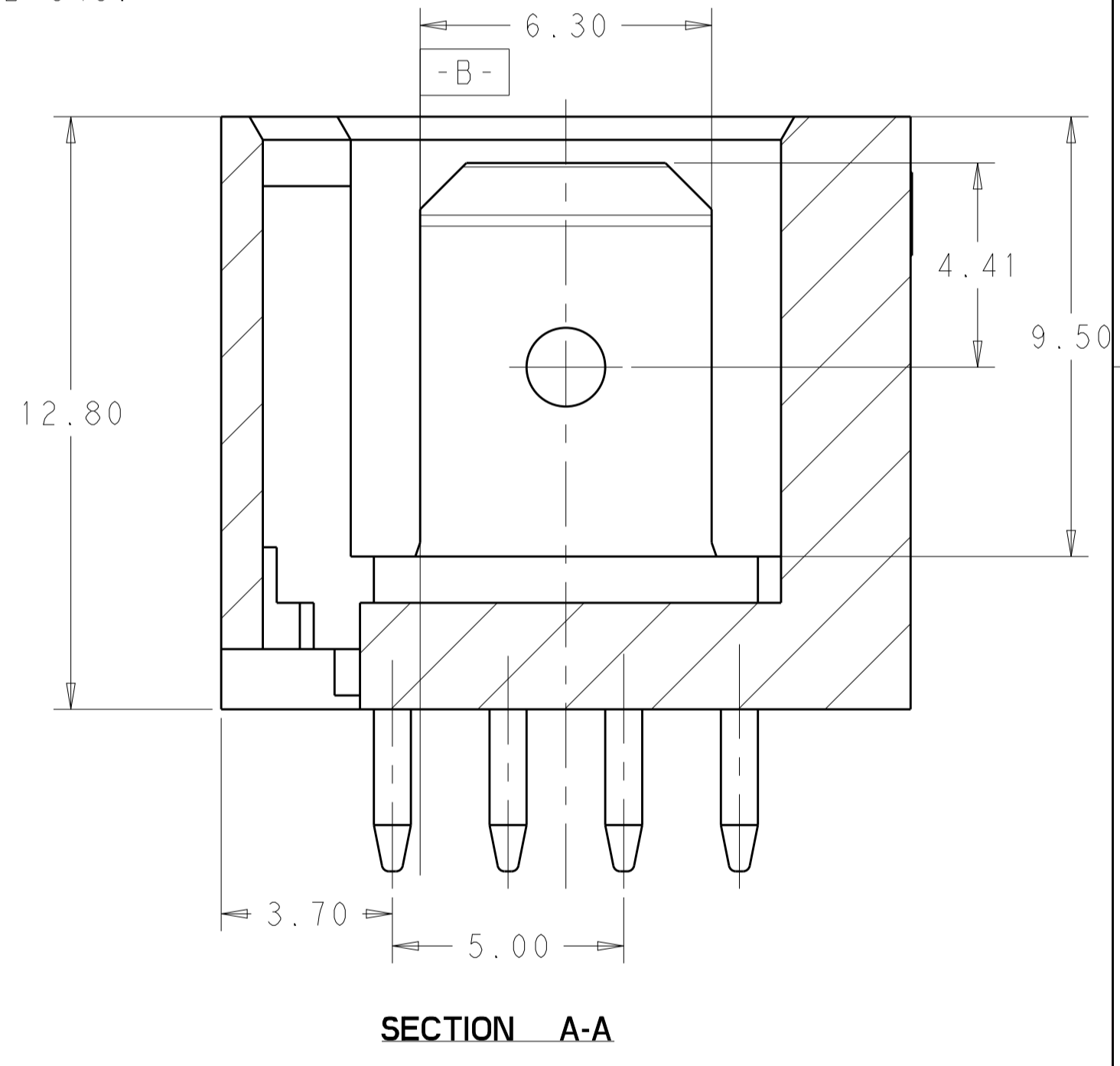
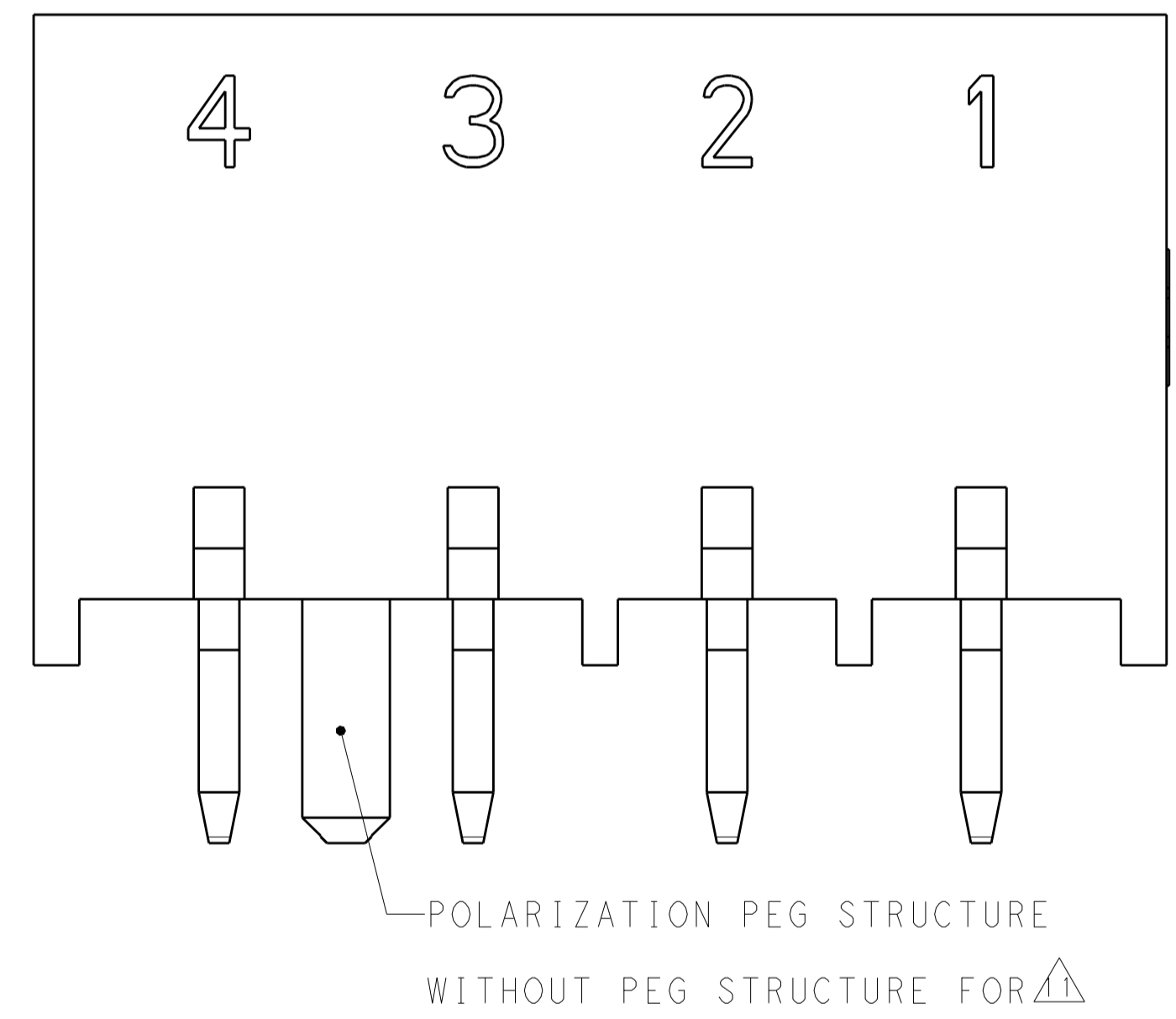
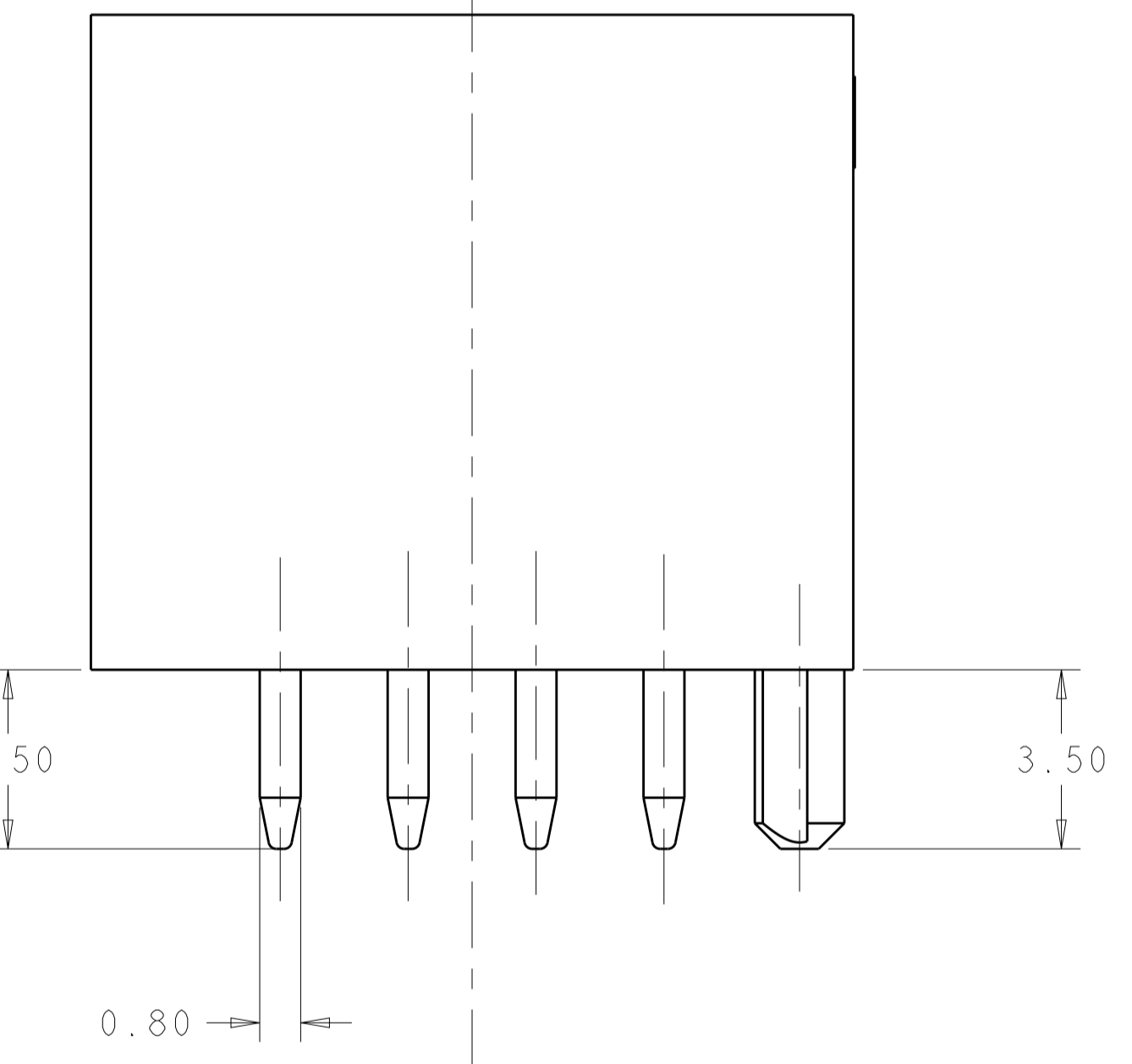
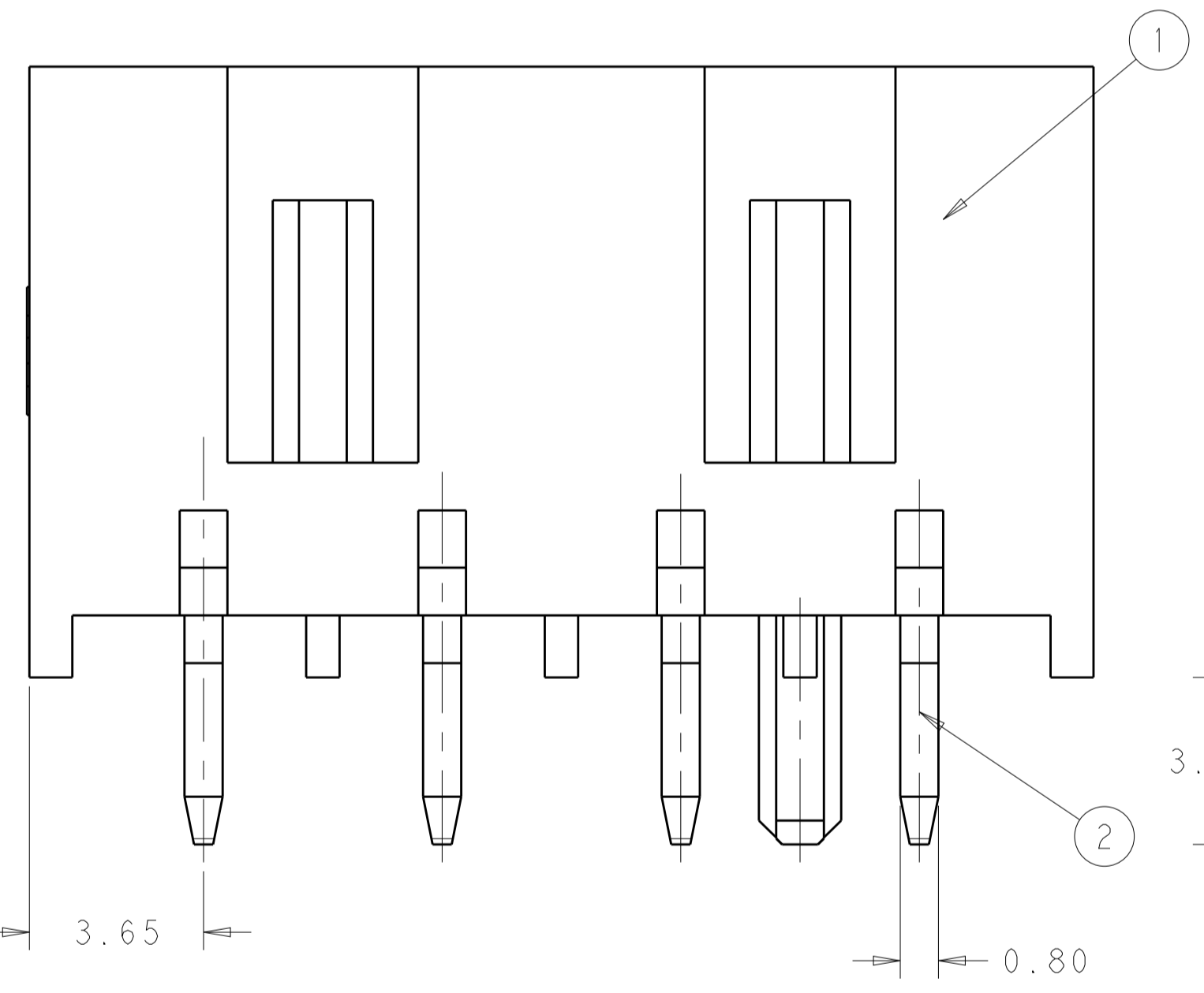

RECOMMEND PCB LAYOUT - SOLDER SIDE  
 EVEN NUMBER OF PINS  
 PCB 15±0.2 THICK

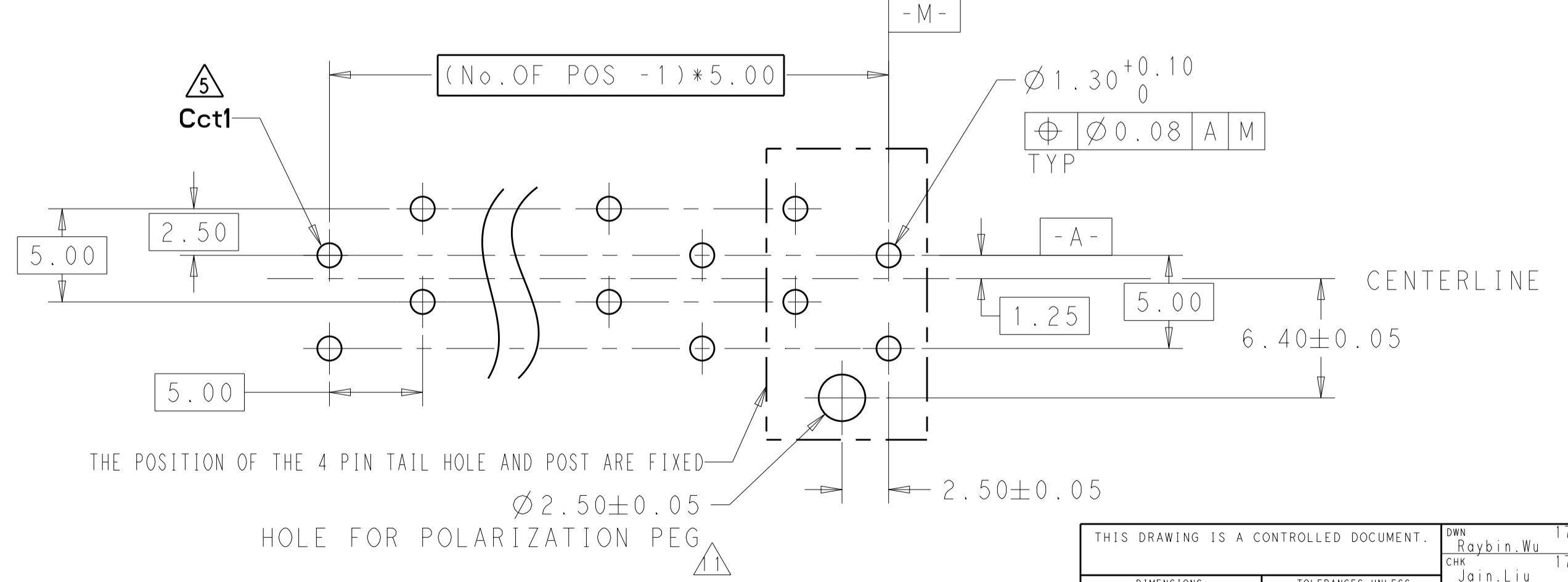

RECOMMEND PCB LAYOUT - SOLDER SIDE  
 ODD NUMBER OF PINS  
 PCB 15±0.2 THICK

42.30	40.30	8
37.30	35.30	7
32.30	30.30	6
27.30	25.30	5
22.30	20.30	4
17.30	15.30	3
12.30	10.30	2
N	M	NO. OF POS.

THIS DRAWING IS A CONTROLLED DOCUMENT.

TE Connectivity

RAST 5 TAB HEADER ASSY, OPPOSITE DIN STYLE, TH, VERTICAL

Customer Drawing

SCALE 5:1 SHEET 1 OF 6 REV A11

LOC	DIST	P	LYR	DESCRIPTION	DATE	OWN	APVD
ES	00	-	-	SEE SHEET 1	-	-	-

QTY	②	QTY	①	NO. OF POS.	TE PART NO.
8	TAB CONTACT MATT TIN PLATING (8-2232043-7 IS WITH BRIGHT TIN)	1	RAST 5 TAB HEADER HOUSING, 8P, NATURE (SEE THE DETAIL LAYOUT ON SHEET 5)	8	5-2232043-8
4-2232043-8					
3-2232043-8					
2-2232043-8					
1-2232043-8					
2232043-8					
9-2232043-7					
8-2232043-7					
7-2232043-7					
6-2232043-7					
5-2232043-7					
4-2232043-7					
3-2232043-7					
2-2232043-7					
1-2232043-7					
2232043-7					
7	TAB CONTACT MATT TIN PLATING (8-2232043-7 IS WITH BRIGHT TIN)	1	RAST 5 TAB HEADER HOUSING, 7P, NATURE (SEE THE DETAIL LAYOUT ON SHEET 5)	7	2232045-6
9-2232043-6					
8-2232043-6					
7-2232043-6					
6-2232043-6					
5-2232043-6					
4-2232043-6					
3-2232043-6					
2-2232043-6					
1-2232043-6					
2232043-6					
2232512-5					
9-2232043-5					
8-2232043-5					
7-2232043-5					
6-2232043-5					
5-2232043-5					
4-2232043-5					
3-2232043-5					
2-2232043-5					
1-2232043-5					
2232043-5					
6	TAB CONTACT MATT TIN PLATING (8-2232043-7 IS WITH BRIGHT TIN)	1	RAST 5 TAB HEADER HOUSING, 6P, NATURE (SEE THE DETAIL LAYOUT ON SHEET 5)	6	5-2232043-5
4-2232043-5					
3-2232043-5					
2-2232043-5					
1-2232043-5					
2232043-5					
9-2232043-4					
8-2232043-4					
7-2232043-4					
6-2232043-4					
5-2232043-4					
4-2232043-4					
3-2232043-4					
2-2232043-4					
1-2232043-4					
2232043-4					
5	TAB CONTACT MATT TIN PLATING (8-2232043-7 IS WITH BRIGHT TIN)	1	RAST 5 TAB HEADER HOUSING, 5P, NATURE (SEE THE DETAIL LAYOUT ON SHEET 4)	5	5-2232043-4
4-2232043-4					
3-2232043-4					
2-2232043-4					
1-2232043-4					
2232043-4					
9-2232043-3					
8-2232043-3					
7-2232043-3					
6-2232043-3					
5-2232043-3					
4-2232043-3					
3-2232043-3					
2-2232043-3					
1-2232043-3					
2303420-3					
2232043-3					

QTY	②	QTY	①	NO. OF POS.	TE PART NO.
4	TAB CONTACT MATT TIN PLATING	1	RAST 5 TAB HEADER HOUSING, 4P, NATURE (SEE THE DETAIL LAYOUT ON SHEET 4)	4	5-2232045-4
4-2232045-4					
3-2232045-4					
2-2232045-4					
2232045-4					
9-2232043-4					
8-2232043-4					
7-2232043-4					
6-2232043-4					
5-2232043-4					
4-2232043-4					
3-2232043-4					
2-2232043-4					
1-2232043-4					
2303420-4					
2232043-4					
3	TAB CONTACT MATT TIN PLATING	1	RAST 5 TAB HEADER HOUSING, 3P, NATURE (SEE THE DETAIL LAYOUT ON SHEET 4)	3	5-2232045-3
4-2232045-3					
3-2232045-3					
2-2232045-3					
1-2232045-3					
2232045-3					
9-2232043-3					
8-2232043-3					
7-2232043-3					
6-2232043-3					
5-2232043-3					
4-2232043-3					
3-2232043-3					
2-2232043-3					
1-2232043-3					
2303420-3					
2232043-3					
2	TAB CONTACT MATT TIN PLATING	1	RAST 5 TAB HEADER HOUSING, 2P, NATURE (SEE THE DETAIL LAYOUT ON SHEET 4)	2	4-2232045-2
3-2232045-2					
2-2232045-2					
1-2232045-2					
2232045-2					
9-2232043-2					
8-2232043-2					
7-2232043-2					
6-2232043-2					
5-2232043-2					
4-2232043-2					
3-2232043-2					
2-2232043-2					
1-2232043-2					
2232043-2					

THIS DRAWING IS A CONTROLLED DOCUMENT.

DIMENSIONS: MEN 	TOLERANCES UNLESS OTHERWISE SPECIFIED: 0 PLC ± 1 PLC ±0.25 2 PLC ± 3 PLC ± 4 PLC ± ANGLES ±2° FINISH	THIS DRAWING IS A CONTROLLED DOCUMENT. CHG. HUIPING_WU 30-Jan-13 HAPYE_WU 30-Jan-13 APVD. YHM 30-Jan-13 PRODUCT SPEC APPLICATION SPEC WEIGHT CUSTOMER DRAWING	NAME: RAST 5 TAB HEADER ASSY, OPPOSITE DIN STYLE, TH, VERTICAL SIZE: A1 CAGE CODE: 00779 DRAWING NO: 2232043 SCALE: N/A SHEET: 2 OF 6 REV: A9
------------------------	---	--	---

LOC	DIST	REV	DATE	BY	APPV
ES	00				

3	TAB CONTACT W/SILVER PLATING	1	RAST 5 TAB HEADER HOUSING, 3P, NATURE (SEE THE DETAIL LAYOUT ON SHEET 4)	3	2316476-3
QTY	②	QTY	①	NO. OF POS.	TE PART NO.

8	TAB CONTACT w/ SILVER PLATING	1	RAST 5 TAB HEADER HOUSING, 8P, NATURE (SEE THE DETAIL LAYOUT ON SHEET 5)	8	5-2232044-8 4-2232044-8 3-2232044-8 2-2232044-8 1-2232044-8 2232044-8
7		1	RAST 5 TAB HEADER HOUSING, 7P, NATURE (SEE THE DETAIL LAYOUT ON SHEET 5)	7	9-2232044-7 8-2232044-7 7-2232044-7 6-2232044-7 5-2232044-7 4-2232044-7 3-2232044-7 2-2232044-7 1-2232044-7 2232044-7
6		1	RAST 5 TAB HEADER HOUSING, 6P, NATURE (SEE THE DETAIL LAYOUT ON SHEET 5)	6	2232046-6 9-2232044-6 8-2232044-6 7-2232044-6 6-2232044-6 5-2232044-6 4-2232044-6 3-2232044-6 2-2232044-6 1-2232044-6 2232044-6
5		1	RAST 5 TAB HEADER HOUSING, 5P, NATURE (SEE THE DETAIL LAYOUT ON SHEET 4)	5	9-2232044-5 8-2232044-5 7-2232044-5 6-2232044-5 5-2232044-5 4-2232044-5 3-2232044-5 2-2232044-5 1-2232044-5 2232044-5
QTY	②	QTY	①	NO. OF POS.	TE PART NO.

4	TAB CONTACT w/ SILVER PLATING	1	RAST 5 TAB HEADER HOUSING, 4P, NATURE (SEE THE DETAIL LAYOUT ON SHEET 4)	4	5-2232046-4 4-2232046-4 3-2232046-4 2-2232046-4 1-2232046-4 2232046-4 9-2232044-4 8-2232044-4 7-2232044-4 6-2232044-4 5-2232044-4 4-2232044-4 3-2232044-4 2-2232044-4 1-2232044-4 2232044-4
3		1	RAST 5 TAB HEADER HOUSING, 3P, NATURE (SEE THE DETAIL LAYOUT ON SHEET 4)	3	4-2232046-3 3-2232046-3 2-2232046-3 1-2232046-3 2232046-3 9-2232044-3 8-2232044-3 7-2232044-3 6-2232044-3 5-2232044-3 4-2232044-3 3-2232044-3 2-2232044-3 1-2232044-3 2232044-3
2		1	RAST 5 TAB HEADER HOUSING, 2P, NATURE (SEE THE DETAIL LAYOUT ON SHEET 4)	2	4-2232046-2 3-2232046-2 2-2232046-2 1-2232046-2 2232046-2 9-2232044-2 8-2232044-2 7-2232044-2 6-2232044-2 5-2232044-2 4-2232044-2 3-2304587-2 3-2232044-2 2-2232044-2 1-2232044-2 2232044-2
QTY		②	QTY	①	NO. OF POS.

THIS DRAWING IS A CONTROLLED DOCUMENT.

DIMENSIONS:	TOLERANCES UNLESS OTHERWISE SPECIFIED:	OWN: HUIPING.WU	CHK: HAPYE.WU	DATE: 30-Jan-13
MATERIAL:	FINISH:	APVD: HAPYE.WU	DATE: 30-Jan-13	NAME: RAST 5 TAB HEADER ASSY, OPPOSITE DIN STYLE, TH, VERTICAL
		PRODUCT SPEC:	APPLICATION SPEC:	RESTRICTED TO:
		SIZE: A1	CAGE CODE: 00779	DRAWING NO: 2232043
		WEIGHT:	SCALE: N/A	SHEET: 3 OF 6
		CUSTOMER DRAWING		REV: A9

LOC	DIST	REV	DATE	BY	APPV
ES	00				

  

REVISIONS					
REV	DATE	BY	APPV	DESCRIPTION	DATE
-	-	-	-	SEE SHEET 1	-

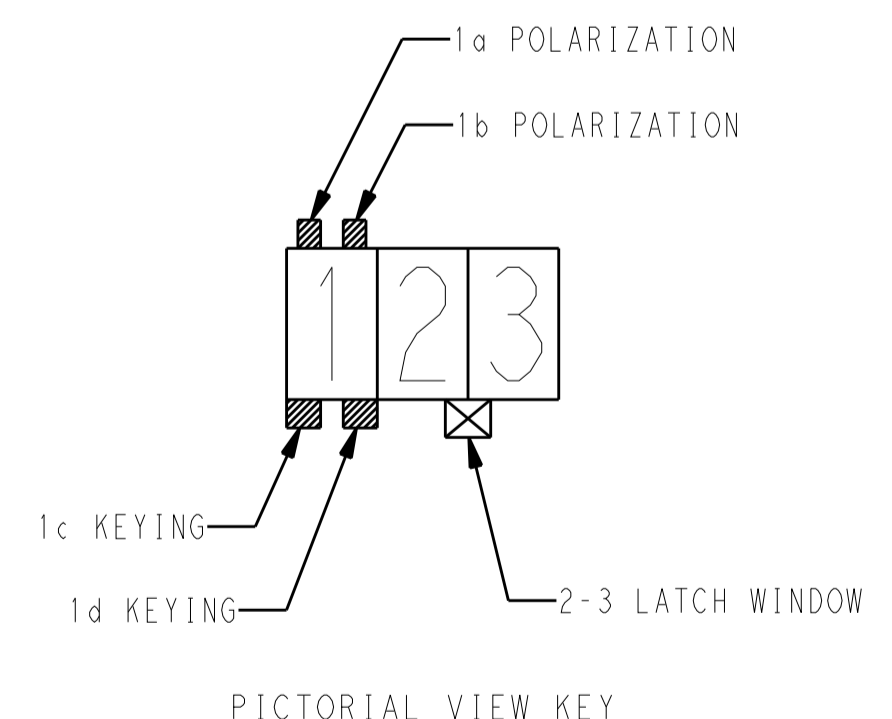

THIS DRAWING IS A CONTROLLED DOCUMENT.		OWN RUIPING WU	30-Jan-13	TE Connectivity NAME RAST 5 TAB HEADER ASSY, OPPOSITE DIN STYLE, TH, VERTICAL
DIMENSIONS:		CHK HAPYE WU	30-Jan-13	
TOLERANCES UNLESS OTHERWISE SPECIFIED:		APVD YIM	30-Jan-13	SIZE A1
mm		PRODUCT SPEC		CAGE CODE 00779
0 PLC ± 1 PLC ± 2 PLC ±0.25 3 PLC ± 4 PLC ± ANGLES ±		APPLICATION SPEC		DRAWING NO 2232043
MATERIAL		FINISH		RESTRICTED TO
		WTGHT		SCALE N/A
		CUSTOMER DRAWING		SHEET 4 OF 6
				REV A9

LOC		DIST		REVISIONS				
ES	00	P	LTN	DESCRIPTION	DATE	OWN	APVD	
-	-	-	-	SEE SHEET 1	-	-	-	

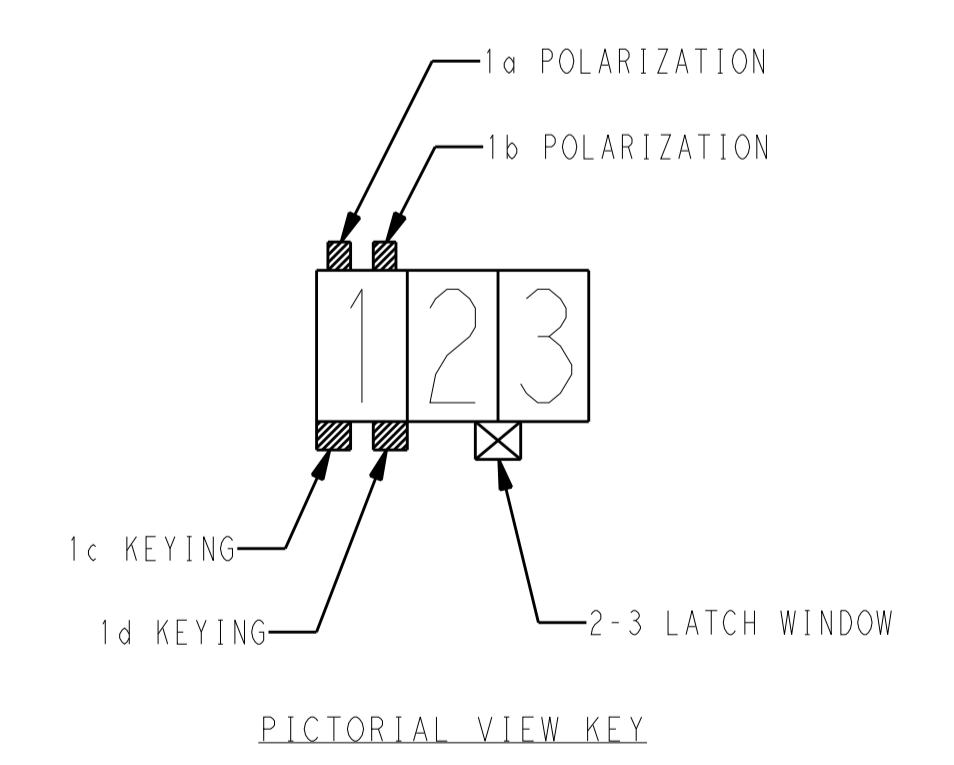
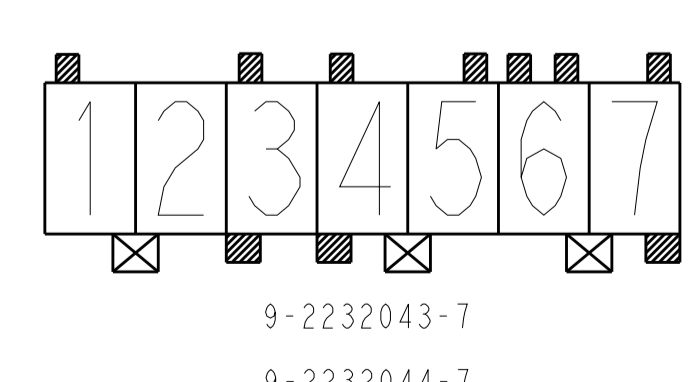
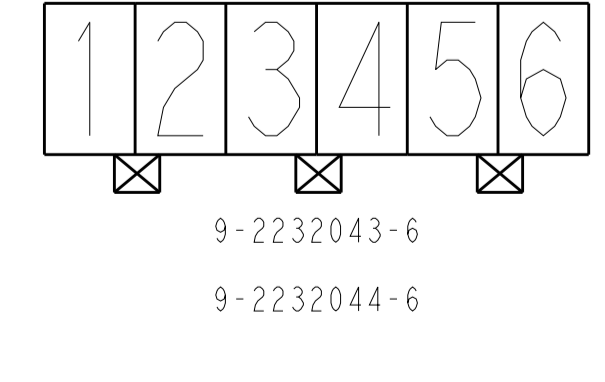
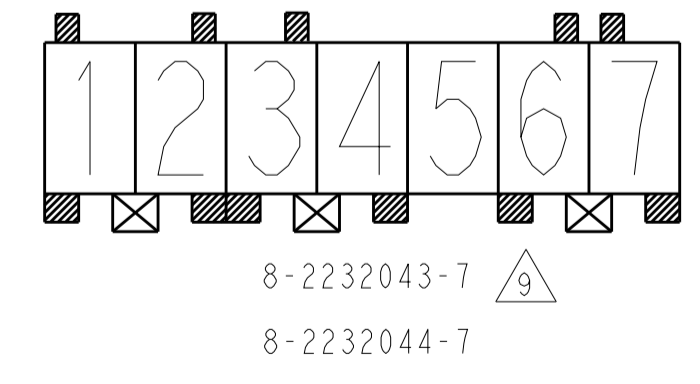
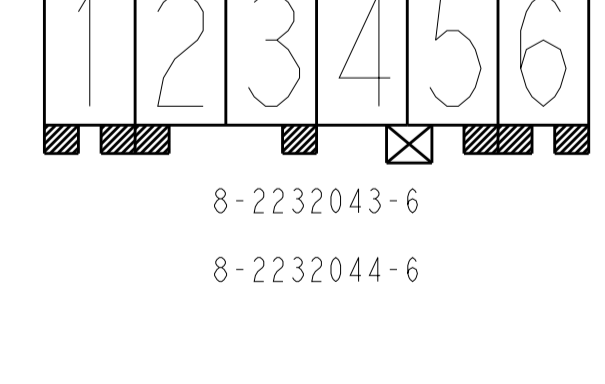
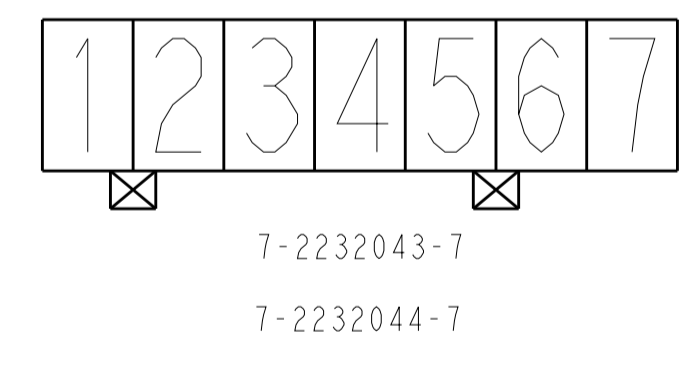
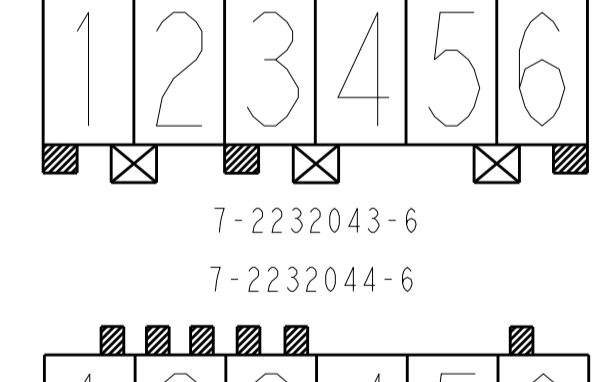
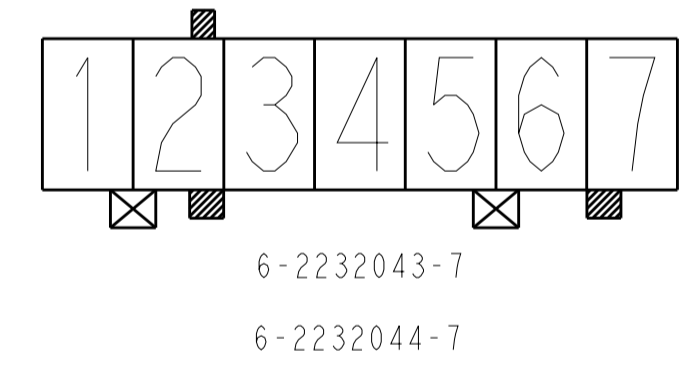
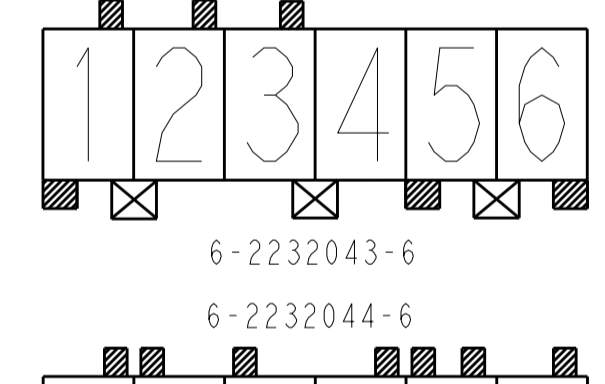
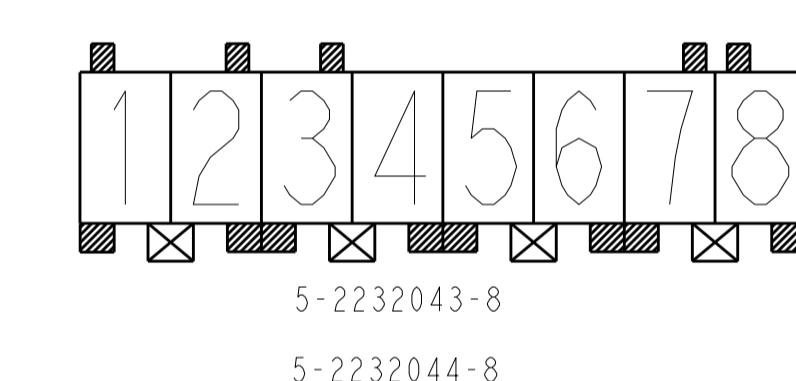
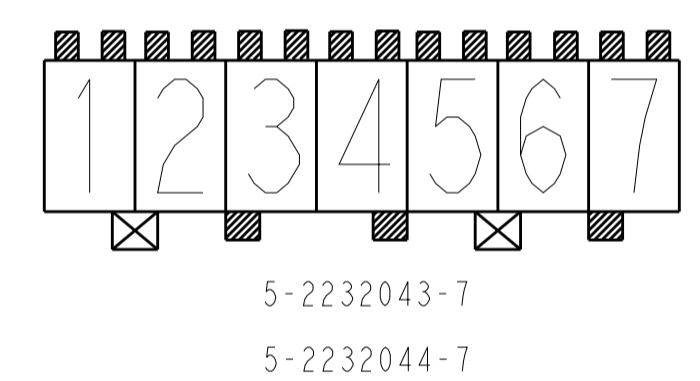
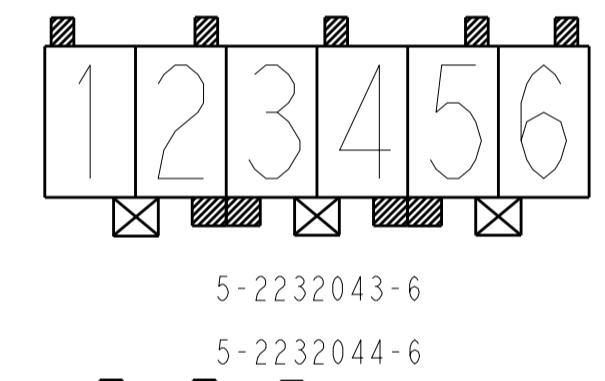
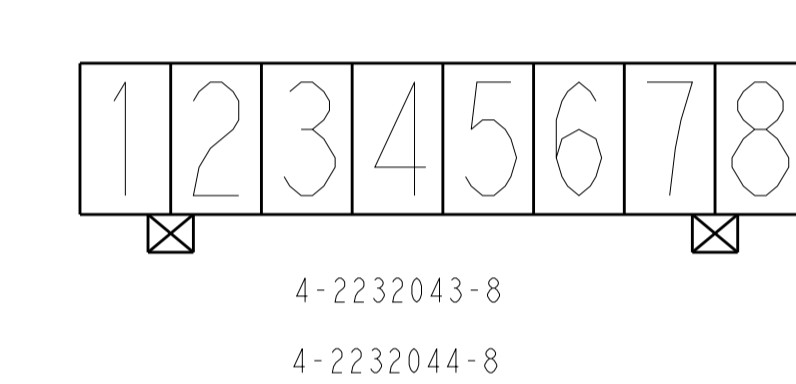
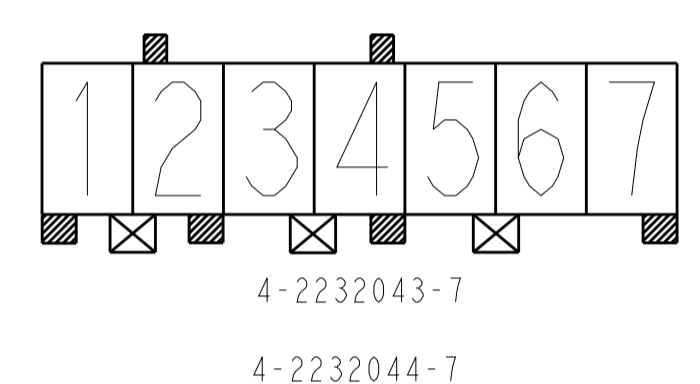
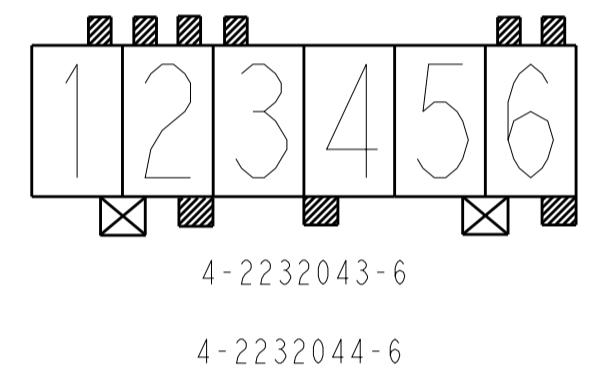
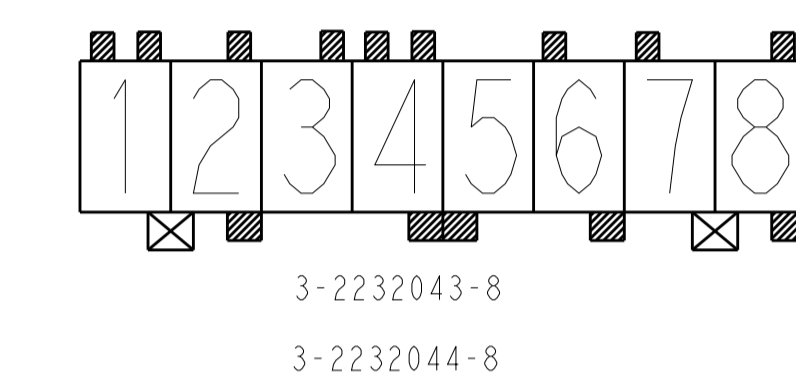
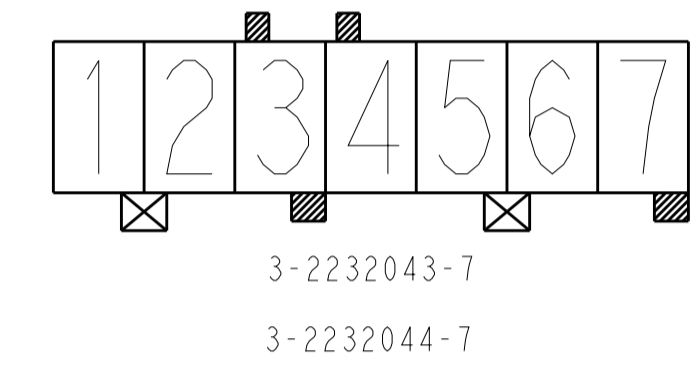
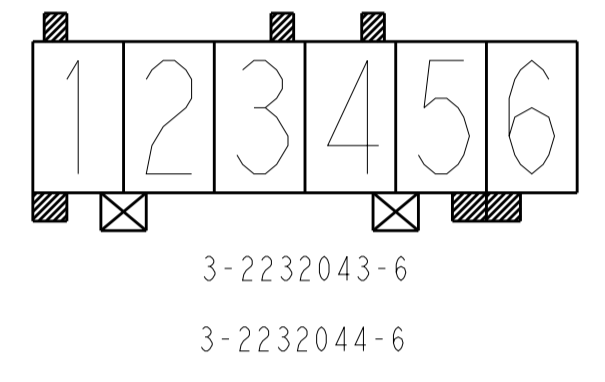
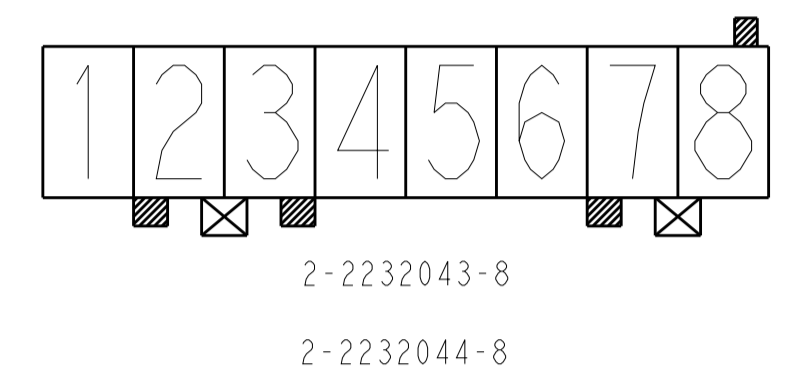
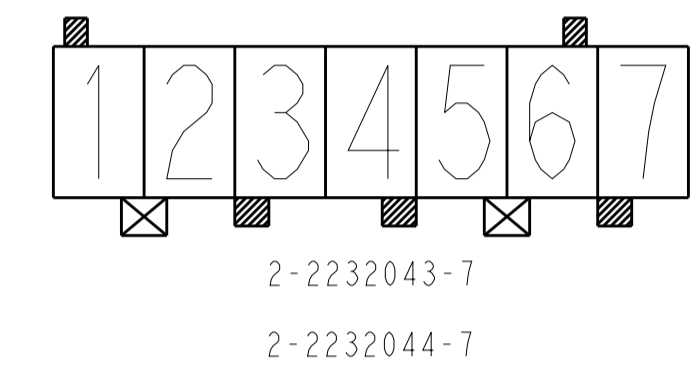
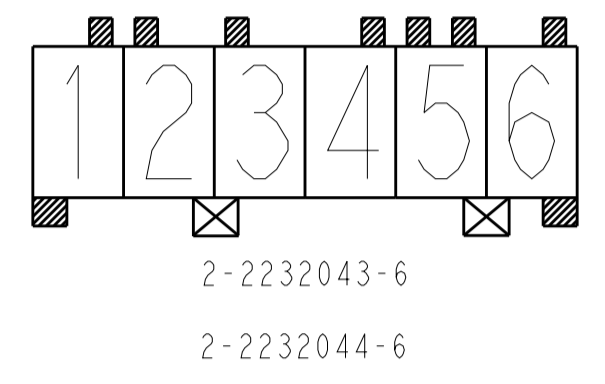
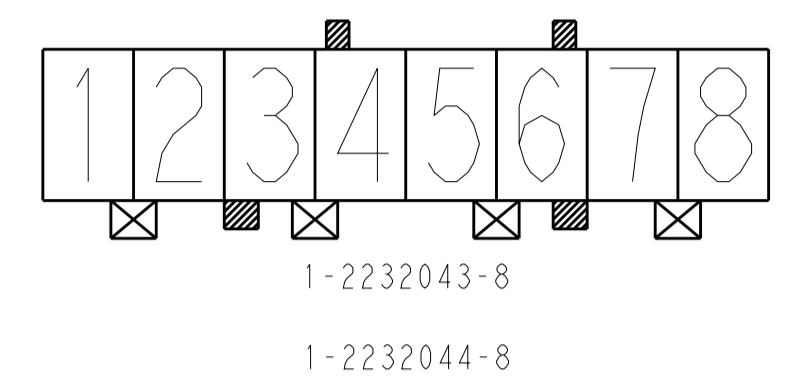
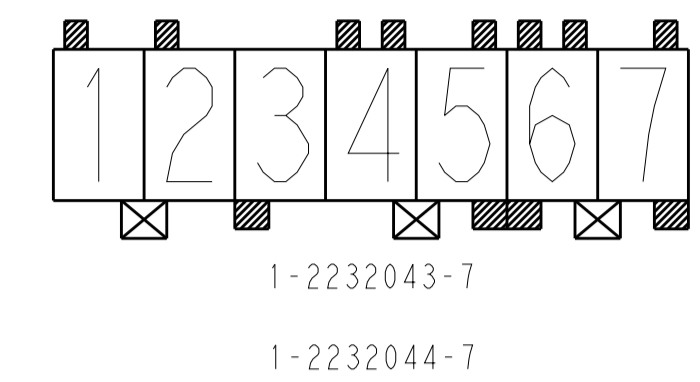
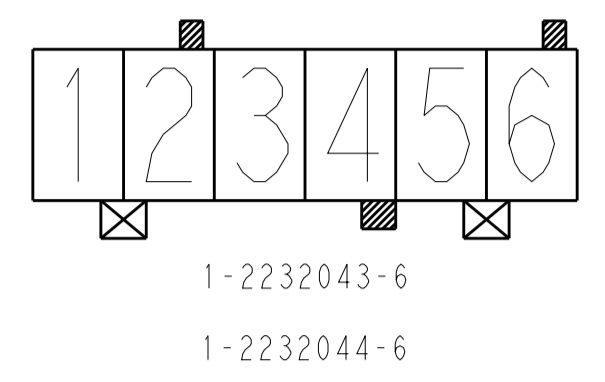
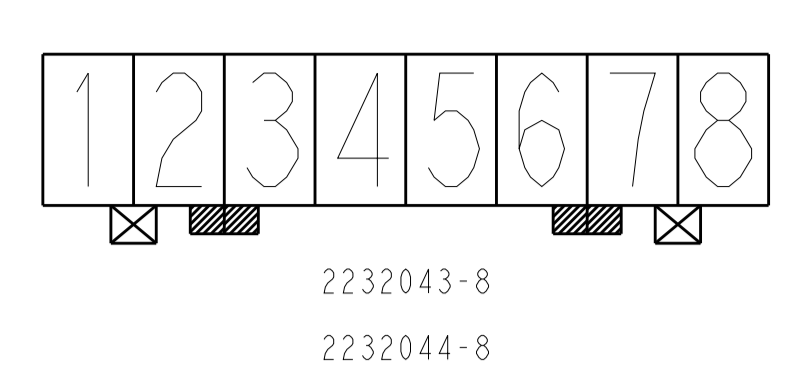
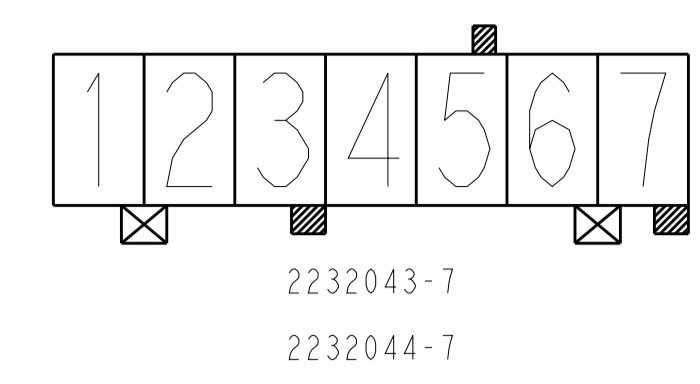
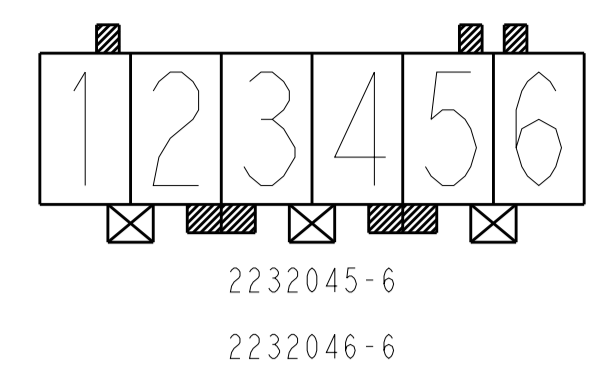
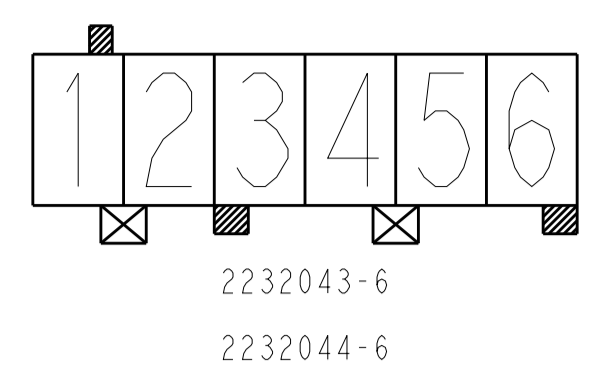

THIS DRAWING IS A CONTROLLED DOCUMENT.		OWN RUIPING WU 30-Jan-13	TE Connectivity
DIMENSIONS:		CHK HAIYU WU 30-Jan-13	
mm	TOLERANCES UNLESS OTHERWISE SPECIFIED:	APVD YIM 30-Jan-13	NAME RAST 5 TAB HEADER ASSY, OPPOSITE DIN STYLE, TH, VERTICAL
	0 PLC ±	PRODUCT SPEC	SIZE A1
	1 PLC ±0.25	APPLICATION SPEC	CAGE CODE 00779
	2 PLC ±	FINISH	DRAWING NO 2232043
	3 PLC ±		RESTRICTED TO
	4 PLC ±		SCALE N/A
	ANGLES ±2°		SHEET 5 OF 6
MATERIAL		WEIGHT	REV A9
		CUSTOMER DRAWING	

FOR ANY KEYING CONFIGURATION, THERE ARE EIGHT COLORS AVAILABLE. BESIDES THE NATURAL COLOR, THERE ARE OTHER SEVEN COLORS, INCLUDE: YELLOW, BLUE, GREY, PURPLE, RED, GREEN, BLACK. THE WHITE VERSION IS PRELIMINARY. THE P/N OF THE COLOR CONNECTOR ARE BASED ON THE NATURAL CONNECTOR. THE PREFIX AND POSTFIX ARE THE SAME FOR THE SAME KEYING CONFIGURATION, BUT THE BASE NUMBERS ARE DIFFERENT ACCORDING TO DIFFERENT COLOR. THE FOLLOWING SHOWS WHAT'S THE P/N FOR COLOR CONNECTOR

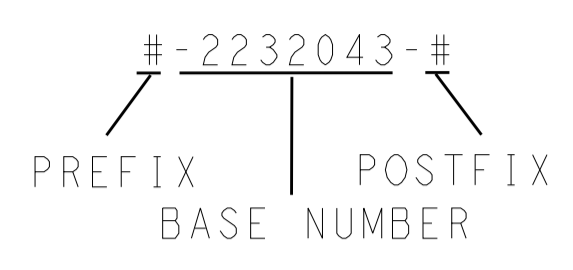

COLOR	PART NUMBER OF THE CONNECTOR				COMMENTS
	WITH MATT TIN PLATING CONTACT (SPECIAL P/N: 8-2232043-7 ARE WITH BRIGHT TIN)		WITH AG PLATING CONTACT		
NATURAL	#-2232043-# 9	#-2232045-#	#-2232044-#	#-2232046-#	THE DETAIL P/N FOR DIFFERENT KEYING SEE SHEET 2-5
RED	#-2232055-#	#-2232057-#	#-2232056-#	#-2232058-#	THE PREFIX AND POSTFIX ARE THE SAME WITH THE P/N OF THE NATURAL CONNECTOR FOR THE SAME KEYING CONFIGURATION, JUST THE BASE NUMBERS ARE DIFFERENT BASED ON DIFFERENT COLOR. # CAN BE THE NUMBER FROM 0 TO 9.
BLUE	#-2232047-#	#-2232049-#	#-2232048-#	#-2232050-#	
YELLOW	#-2232063-#	#-2232065-#	#-2232064-#	#-2232066-#	
BALCK	#-2232059-#	#-2232061-#	#-2232060-#	#-2232062-#	
GREY	#-2232067-#	#-2232069-#	#-2232068-#	#-2232070-#	
GREEN	#-2232051-#	#-2232053-#	#-2232052-#	#-2232054-#	
PURPLE	#-2232071-#	#-2232073-#	#-2232072-#	#-2232074-#	
WHITE	#-2232298-#	#-2232300-#	#-2232299-#	#-2232301-#	

COLOR	PART NUMBER OF THE CONNECTOR		COMMENTS
	WITH BRIGHT PLATING CONTACT		
NATURAL	#-2232924-#	#-2232925-#	THE KEYING, POLARIZATION AND LATCH WINDOW CONFIGURATION ARE SAME AS THE MATT TIN CONNECTOR WITH THE SAME PREFIX AND POSTFIX FOR EACH COLOR. FOR EXAMPLE: 2232924-4 AND 2232043-4 HAVE SAME KEYING, POLARIZATION AND LATCH WINDOW CONFIGURATION. 2232925-4 AND 2232045-4 HAVE SAME KEYING, POLARIZATION AND LATCH WINDOW CONFIGURATION. THE DETAIL KEYING, POLARIZATION AND LATCH WINDOW CONFIGURATION FOR EACH P/N, PLEASE SEE SHEET 2-5
RED	#-2232926-#	#-2232927-#	
BLUE	#-2232928-#	#-2232929-#	
YELLOW	#-2232930-#	#-2232931-#	
BALCK	#-2232932-#	#-2232933-#	
GREY	#-2232934-#	#-2232935-#	
GREEN	#-2232936-#	#-2232937-#	
PURPLE	#-2232938-#	#-2232939-#	
WHITE	#-2232940-#	#-2232941-#	

FOR EXAMPLE, IF A CONNECTOR WITH THE CONFIGURATION AS BELOW, AND WITH TIN PLATING CONTACT, IN THE SHEET 4, WE CAN FIND THE RELATED CONNECTOR P/N WITH NATURAL COLOR IS 1-2232043-4, THEN WE CAN LOOK IN THE ABOVE TABLE TO FIND THE CONNECTOR P/N WITH RED COLOR IS 1-2232055-4

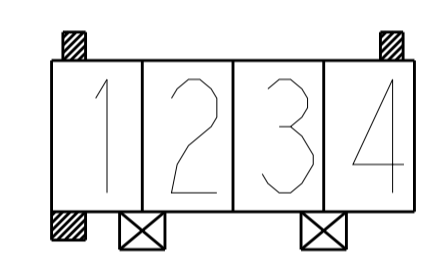

1-2232043-4

FOR ANOTHER EXAMPLE, IF A CONNECTOR WITH THE CONFIGURATION AS BELOW, AND WITH TIN PLATING CONTACT, IN THE SHEET 4, WE CAN FIND THE RELATED CONNECTOR P/N WITH NATURAL COLOR IS 1-2232045-4, THEN WE CAN LOOK IN THE ABOVE TABLE TO FIND THE CONNECTOR P/N WITH RED COLOR IS 1-2232057-4

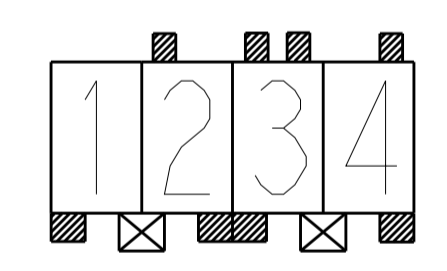

1-2232045-4

THIS DRAWING IS A CONTROLLED DOCUMENT.		DWN RUIPING.WU 10-Jul-17	TE Connectivity
DIMENSIONS:		CHK HAPYE.WU 10-Jul-17	
mm	TOLERANCES UNLESS OTHERWISE SPECIFIED:	APVD YIUM 10-Jul-17	NAME RAST 5 TAB HEADER ASSY, OPPOSITE DIN STYLE, TH, VERTICAL
0 PLC ±-	1 PLC ±-	PRODUCT SPEC	SIZE A100779C=2232043
2 PLC ±0.25	3 PLC ±-	APPLICATION SPEC	RESTRICTED TO
4 PLC ±-	ANGLES ±°	WEIGHT	SCALE 5:1 SHEET 6 OF 6 REV A11
MATERIAL	FINISH	Customer Drawing	