

Product Specification

XBLW AOD413A

P-Channel Enhancement Mode MOSFET

WEB | www.xinboleic.com



Description

The AOD413A uses advanced trench technology to provide excellent RDS(ON), low gate charge and operation with gate voltages as low as 4.5V. This device is suitable for use as a Battery protection or in other Switching application.

General Features

- VDS = -40V ID = -25A
- RDS(ON) < 44 mΩ@VGS=10V

Application

- Battery protection
- Load switch
- Uninterruptible power supply

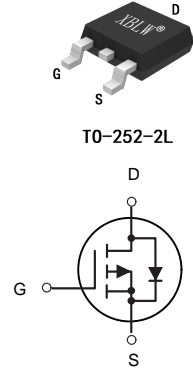

P-Channel MOSFET

Package Marking and Ordering Information

Product Model	Package Type	Marking	Packing	Packing Qty
XBLW AOD413A	TO-252-2L	AOD413A	Tape	2500Pcs/Reel

Absolute Maximum Ratings (TC=25°C unless otherwise noted)

Symbol	Parameter	Rating	Units
VDS	Drain-Source Voltage	-40	V
VGS	Gate-Source Voltage	±25	V
ID@TC=25°C	Continuous Drain Current, VGS @ 10V ¹	-25	A
ID@TC=100°C	Continuous Drain Current, VGS @ 10V ¹	-12	A
IDM	Pulsed Drain Current ²	-40	A
PD@TC=25°C	Total Power Dissipation ⁴	8	W
TSTG	Storage Temperature Range	-55 to 150	°C
TJ	Operating Junction Temperature Range	-55 to 150	°C
ReJA	Thermal Resistance Junction-ambient ¹	62	°C/W
ReJC	Thermal Resistance Junction-Case ¹	18.8	°C/W

Electrical Characteristics (T_J=25°C unless otherwise specified)

Symbol	Parameter	Test Condition	Min.	Typ.	Max.	Units
Off Characteristic						
V _{(BR)DSS}	Drain-Source Breakdown Voltage	V _{GS} =0V, I _D = -250μA	-40	-	-	V
I _{DSS}	Zero Gate Voltage Drain Current	V _{DS} = -40V, V _{GS} =0V	-	-	-1	μA
I _{GSS}	Gate to Body Leakage Current	V _{DS} =0V, V _{GS} = ±20V	-	-	±100	nA
On Characteristics						
V _{GS(th)}	Gate Threshold Voltage	V _{DS} =V _{GS} , I _D = -250μA	-1.0	-1.6	-2.5	V
R _{DS(on)}	Static Drain-Source on-Resistance <small>note3</small>	V _{GS} = -10V, I _D = -8A	-	31	44	mΩ
		V _{GS} = -4.5V, I _D = -5A	-	44	60	
Dynamic Characteristics						
C _{iss}	Input Capacitance	V _{DS} = -20V, V _{GS} =0V, f=1.0MHz	-	1034	-	pF
C _{oss}	Output Capacitance		-	107	-	pF
C _{rss}	Reverse Transfer Capacitance		-	79.5	-	pF
Q _g	Total Gate Charge	V _{DS} = -20V, I _D = -5A, V _{GS} = -10V	-	20	-	nC
Q _{gs}	Gate-Source Charge		-	3.5	-	nC
Q _{gd}	Gate-Drain("Miller") Charge		-	4.2	-	nC
Switching Characteristics						
t _{d(on)}	Turn-on Delay Time	V _{DD} = -20V, I _D = -5A, V _{GS} = -10V, R _{GEN} =2.5Ω	-	8	-	ns
t _r	Turn-on Rise Time		-	15	-	ns
t _{d(off)}	Turn-off Delay Time		-	23	-	ns
t _f	Turn-off Fall Time		-	9	-	ns
Drain-Source Diode Characteristics and Maximum Ratings						
I _S	Maximum Continuous Drain to Source Diode Forward Current		-	-	-23	A
I _{SM}	Maximum Pulsed Drain to Source Diode Forward Current		-	-	-40	A
V _{SD}	Drain to Source Diode Forward Voltage	V _{GS} =0V, I _S = -10A	-	-0.8	-1.2	V
t _{rr}	Reverse Recovery Time	V _{GS} =0V, I _S =-5A,	-	29	-	ns
Q _{rr}	Reverse Recovery Charge	di/dt=100A/μs	-	20	-	nC

Notes:1. Repetitive Rating: Pulse Width Limited by Maximum Junction Temperature

 2. EAS condition: T_J= 25°C, V_{DD}= -20V, V_G= -10V, L=0.5mH, R_G= 25Ω, I_{AS}= -10.5A

3. Pulse Test: Pulse Width≤300μs, Duty Cycle≤2%

Typical Performance Characteristics

Figure 1: Output Characteristics

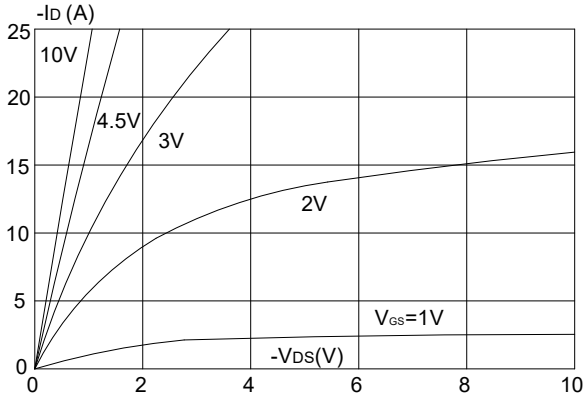

Figure 2: Typical Transfer Characteristics

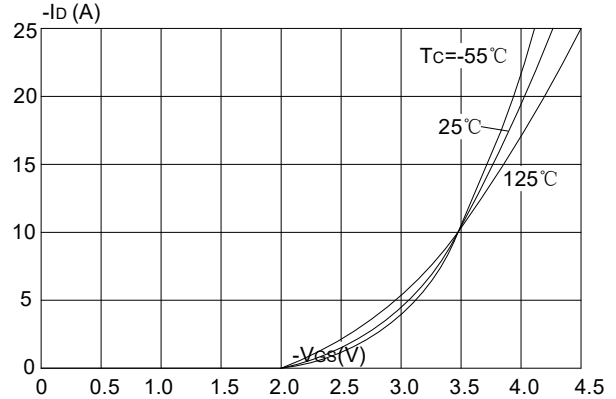

Figure 3: On-resistance vs. Drain Current

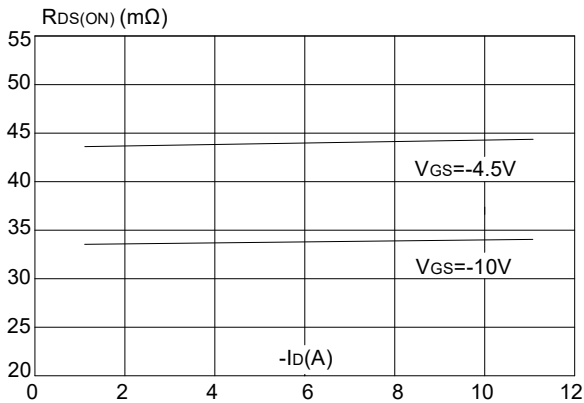

Figure 4: Body Diode Characteristics

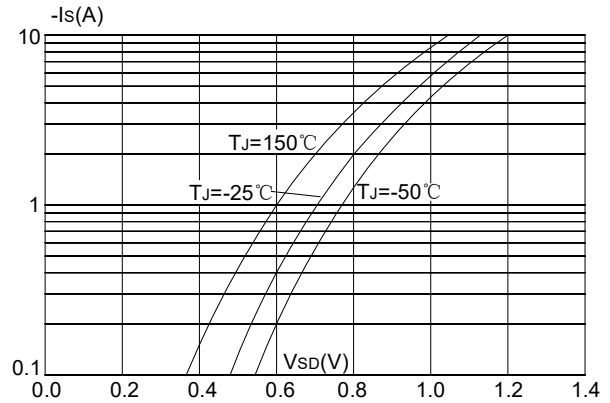

Figure 5: Gate Charge Characteristics

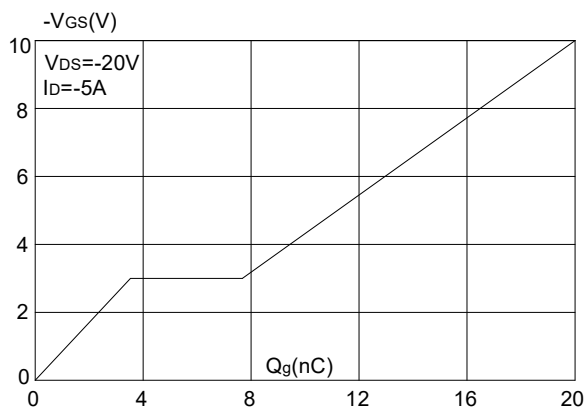

Figure 6: Capacitance Characteristics

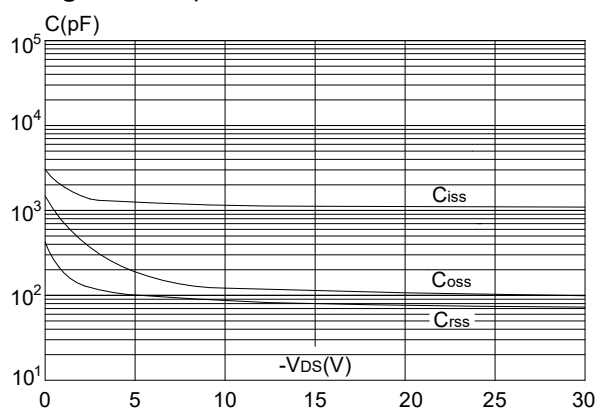

Figure 7: Normalized Breakdown Voltage vs. Junction Temperature

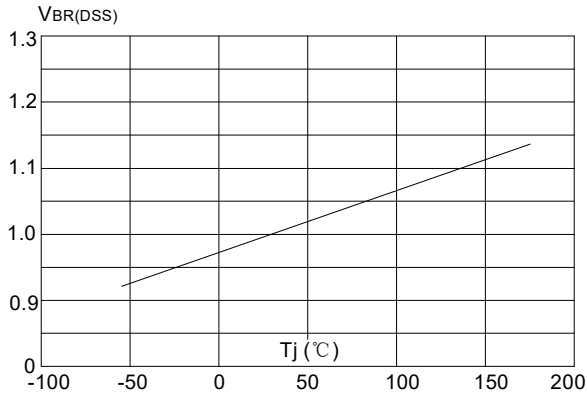

Figure 8: Normalized on Resistance vs. Junction Temperature

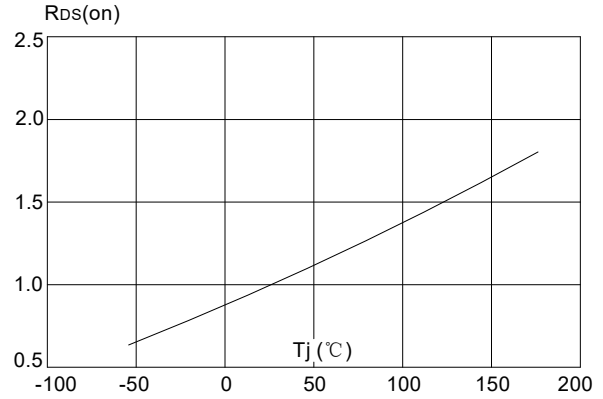

Figure 9: Maximum Safe Operating Area

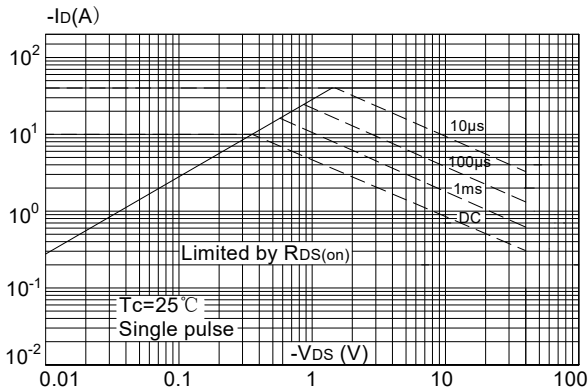

Figure 10: Maximum Continuous Drain Current vs. Case Temperature

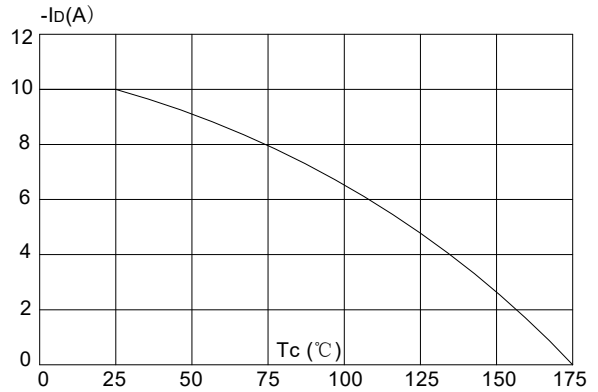
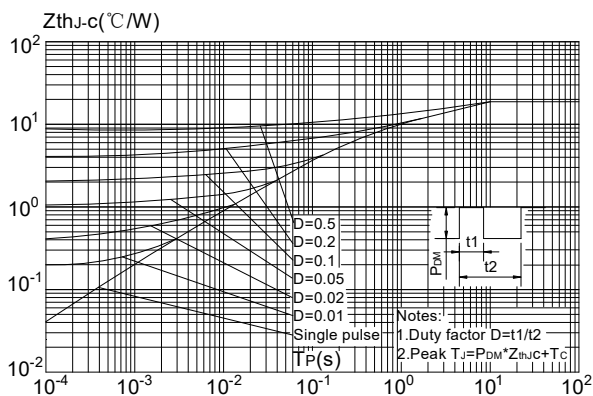

Figure 11: Maximum Effective Transient Thermal Impedance, Junction-to-Case



Test Circuit

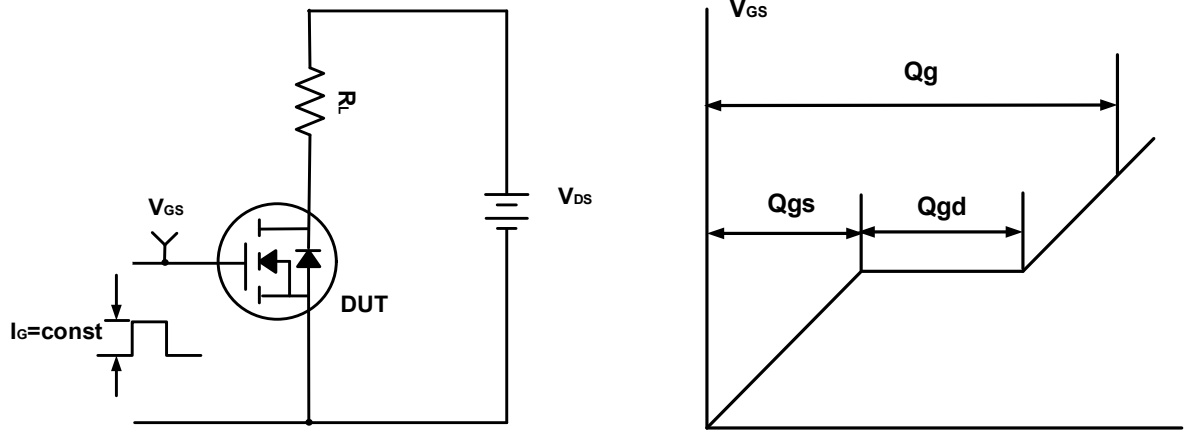

Figure A. Gate Charge Test Circuit & Waveforms

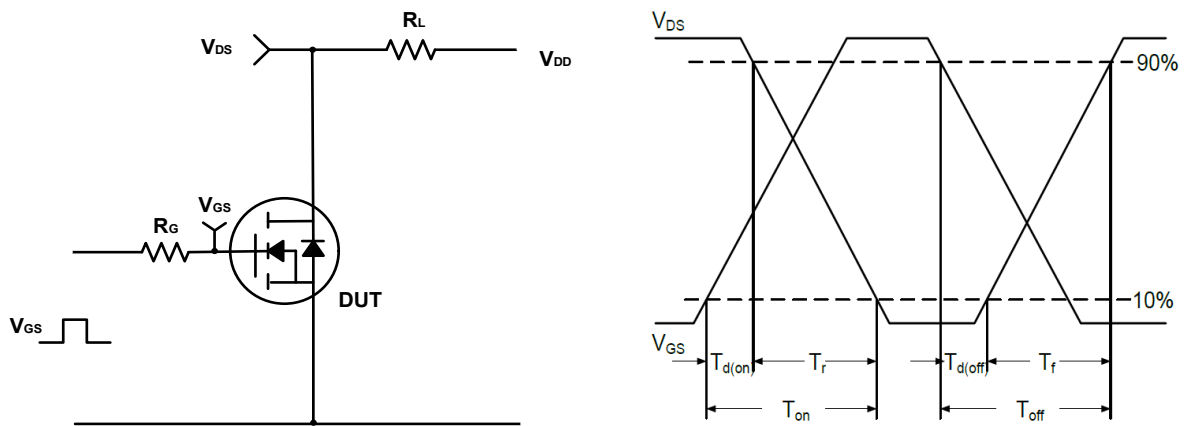

Figure B. Switching Test Circuit & Waveforms

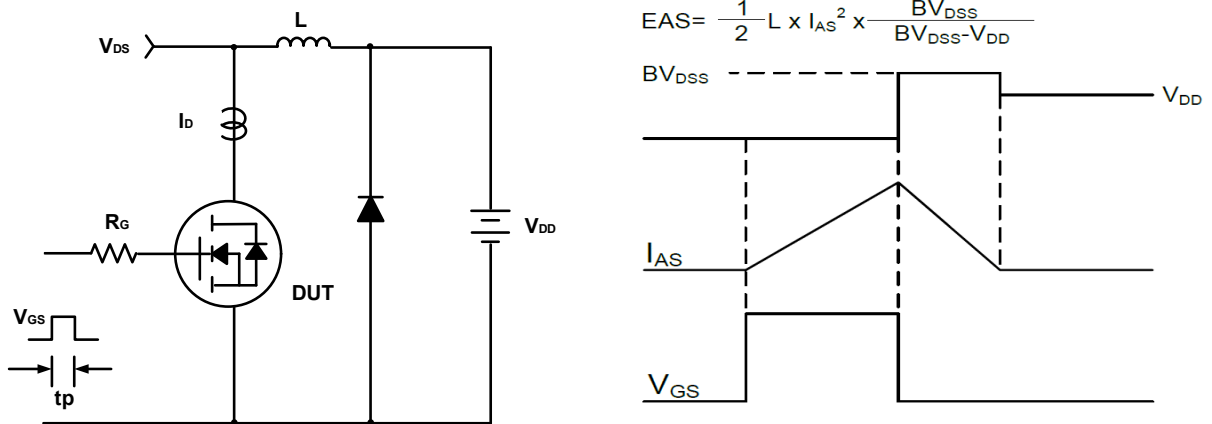
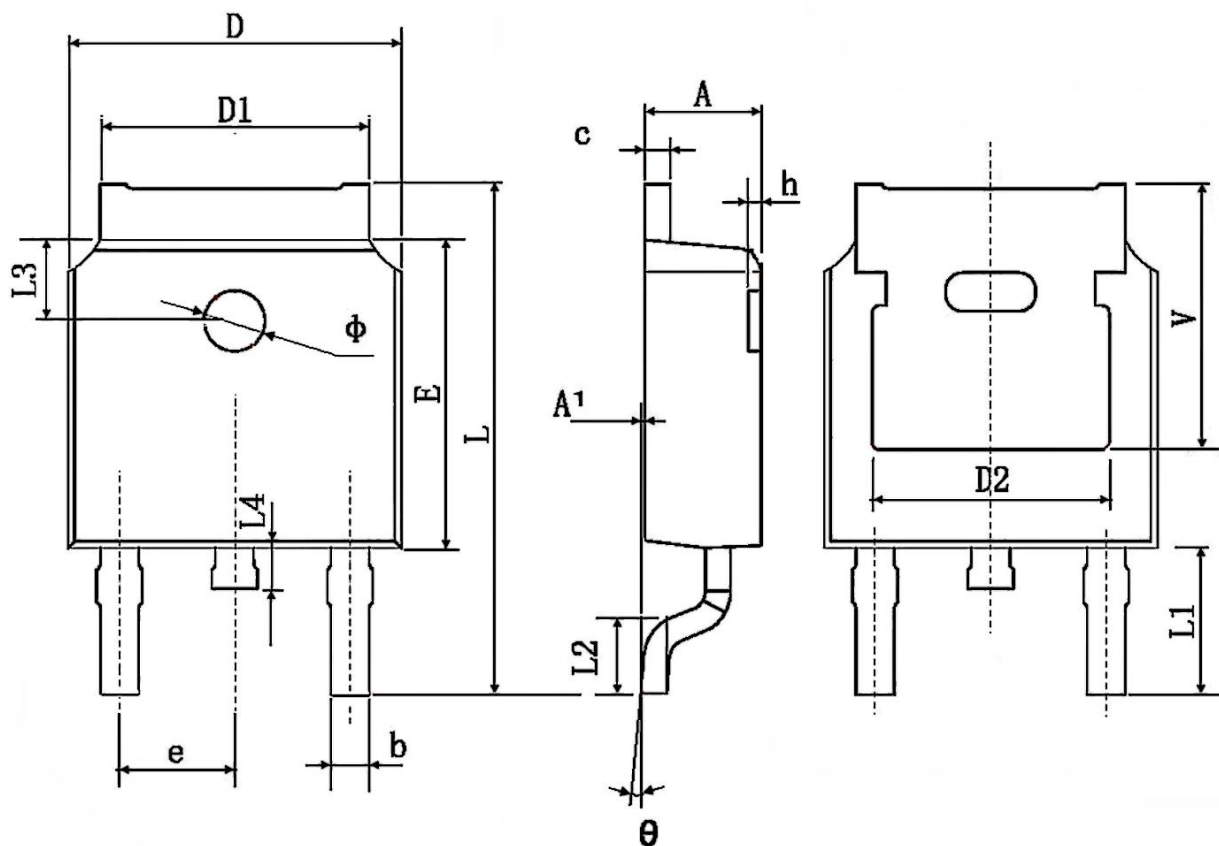

Figure C. Unclamped Inductive Switching Circuit & Waveforms

Package Information

T0252-2L



Symbol	Dimensions In Millimeters		Dimensions In Inches	
	Min.	Max.	Min.	Max.
A	2.200	2.400	0.087	0.094
A1	0.000	0.127	0.000	0.005
b	0.660	0.860	0.026	0.034
c	0.460	0.580	0.018	0.023
D	6.500	6.700	0.256	0.264
D1	5.100	5.460	0.201	0.215
D2	4.830 TYP.		0.190 TYP.	
E	6.000	6.200	0.236	0.244
e	2.186	2.386	0.086	0.094
L	9.800	10.400	0.386	0.409
L1	2.900 TYP.		0.114 TYP.	
L2	1.400	1.700	0.055	0.067
L3	1.600 TYP.		0.063 TYP.	
L4	0.600	1.000	0.024	0.039
φ	1.100	1.300	0.043	0.051
θ	0°	8°	0°	8°
h	0.000	0.300	0.000	0.012
V	5.350 TYP.		0.211 TYP.	

Statement:

- XBLW reserves the right to modify the product manual without prior notice! Before placing an order, customers need to confirm whether the obtained information is the latest version and verify the completeness of the relevant information.
- Any semi-guide product is subject to failure or malfunction under specified conditions. It is the buyer's responsibility to comply with safety standards when using XBLW products for system design and whole machine manufacturing. And take the appropriate safety measures to avoid the potential in the risk of loss of personal injury or loss of property situation!
- XBLW products have not been licensed for life support, military, and aerospace applications, and therefore XBLW is not responsible for any consequences arising from the use of this product in these areas.
- If any or all XBLW products (including technical data, services) described or contained in this document are subject to any applicable local export control laws and regulations, they may not be exported without an export license from the relevant authorities in accordance with such laws.
- The specifications of any and all XBLW products described or contained in this document specify the performance, characteristics, and functionality of said products in their standalone state, but do not guarantee the performance, characteristics, and functionality of said products installed in Customer's products or equipment. In order to verify symptoms and conditions that cannot be evaluated in a standalone device, the Customer should ultimately evaluate and test the device installed in the Customer's product device.
- XBLW documentation is only allowed to be copied without any alteration of the content and with the relevant authorization. XBLW assumes no responsibility or liability for altered documents.
- XBLW is committed to becoming the preferred semiconductor brand for customers, and XBLW will strive to provide customers with better performance and better quality products.