

General Specifications

Electrical Capacity (Resistive Load)

Power Level (silver):	5A @ 125/250V AC or 5A @ 30V DC
Logic Level (gold):	0.4VA maximum @ 28V AC/DC maximum (Applicable Range 0.1mA ~ 0.1A @ 20mV ~ 28V)
	Note: Find additional explanation of operating range in Supplement section.

Other Ratings

Contact Resistance:	50 milliohms maximum for silver; 100 milliohms maximum for gold
Insulation Resistance:	200 megohms minimum @ 500V DC
Dielectric Strength:	1,000V AC minimum between contacts for 1 minute minimum; 1,500V AC minimum between contacts & case for 1 minute minimum
Mechanical Life:	1,000,000 operations minimum for momentary; 200,000 operations minimum for alternate action
Electrical Life:	10,000 operations minimum for silver; 100,000 operations minimum for silver with resistive load of 3A @ 125V AC 200,000 operations minimum for gold
Nominal Operating Force:	Single Pole: 1.9N for Square & 1.9N for Rectangular Double Pole: 2.55N for Square & 3.1N for Rectangular
Contact Timing:	Break before make
Travel:	Pretravel .067" (1.7mm); Overtravel .024" (0.6mm); Total Travel .091" (2.3mm)

Materials & Finishes

Housing/Bezel:	Glass fiber reinforced polyamide (UL94V-0)
Snap-in Frame:	Stainless steel
Movable Contact:	Phosphor bronze
Movable Contacts:	Silver alloy or copper with gold plating
Stationary Contacts:	Silver alloy or copper with gold plating
Switch Terminals:	Phosphor bronze with silver or gold plating
Lamp Terminals:	Brass with silver plating
Base:	Glass fiber reinforced liquid crystal polymer (UL94V-0)

Environmental Data

Operating Temperature Range:	-25°C through +50°C (-13°F through +122°F) for Illuminated -20°C through +70°C (-4°F through +158°F) for Nonilluminated
Humidity:	90 ~ 95% humidity for 96 hours @ 40°C (104°F)
Vibration:	10 ~ 55Hz with peak-to-peak amplitude of 1.5mm traversing the frequency range & returning in 1 minute; 3 right angled directions for 2 hours
Shock:	50G (490m/s ²) acceleration (tested in 6 right angled directions, with 5 shocks in each direction)

Installation

Cap Installation Force:	7.55N (1.70 lbf) maximum downward force on cap
Soldering Time & Temp:	Wave Soldering (PC version): See Profile A in Supplement section. Manual Soldering: See Profile A in Supplement section.
Cleaning:	These devices are not process sealed. Hand clean locally using alcohol based solution.

Standards & Certifications

Flammability Standards:	UL94V-0 housing/bezel & base
UL:	File No. E44145 - Recognized only when ordered with marking on switch. Add "/U" or "/CUL" before dash in part number to order UL recognized switch. UL recognized only when ordered switch body with cap assembled. All single & double pole models recognized at 5A @ 125/250V AC or 0.014A @ 28V DC.
CSA:	File No. 023535_0_000 - Certified only when ordered with marking on switch. Add "/C" before dash in part number to order CSA certified switch. All single & double pole models certified at 5A @ 125/250V AC or 5A @ 30V DC or 0.4VA maximum @ 28V AC/DC maximum.

Distinctive Characteristics

Red/green and amber/blue bicolors with alternating standard or custom legends.
Super bright LED provides brilliant uniform illumination.

Bright or super bright LEDs (an integral part of the switch) of red, amber, green, blue, or white, in full face or spot illumination plus square or rectangular models.

Combination of PCB mountability and short body allows use in compact applications.

Small behind panel dimension for snap-in mounting in tight spaces.

Snap-acting contact mechanism provides sensitive actuation with audible feedback; quick-make, quick-break characteristic limits arcing and prolongs electrical life.

Latchdown mechanism, independent of switching mechanism, gives visible and tactile indication of circuit status.

Terminals are epoxy sealed to lock out flux, solvents, and other contaminants.

Momentary and alternate action circuits available in the same space-saving body size.

Matching indicators available.

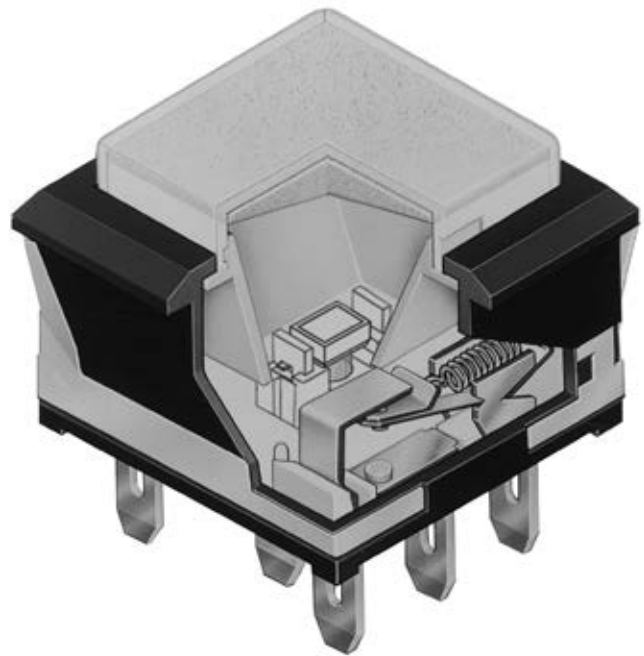

Actual Size

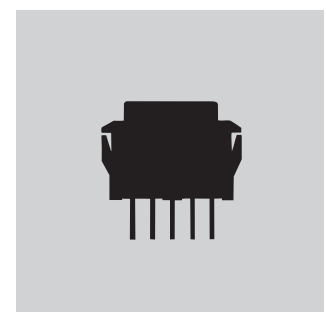

- Supplement
- Accessories
- Indicators
- Touch
- Tilt
- Tactiles
- Slides
- Rotaries
- Keylocks
- Programmable
- D** Illuminated PB
- Pushbuttons
- Rockers
- Toggles

TYPICAL SWITCH

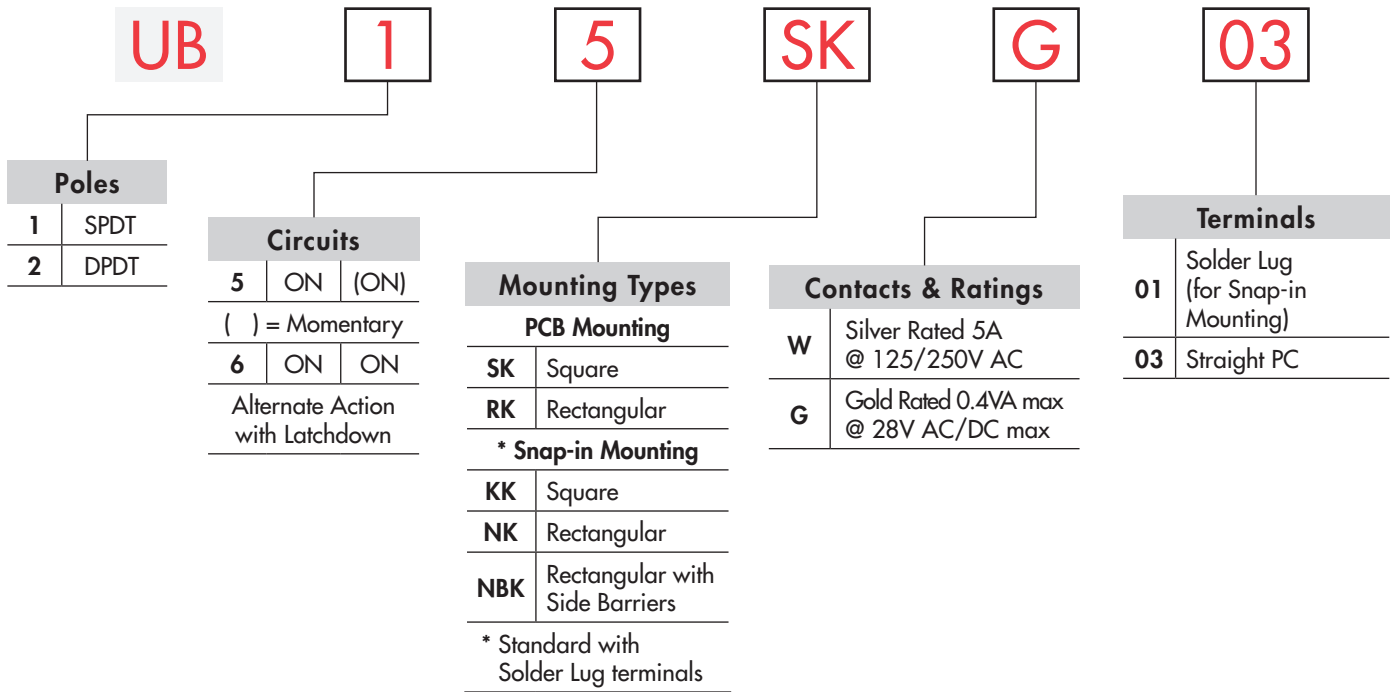

IMPORTANT:

Switches are supplied without UL, cULus & CSA marking unless specified. **UL, cULus & CSA recognized only when ordered with marking on the switch.** Specific models, ratings, & ordering instructions are noted on General Specifications page.



DESCRIPTION FOR TYPICAL ORDERING EXAMPLE

UB15SKG035C-CC

Gold Contacts with 0.4VA Rating
Square with PCB Mounting



Red, Bright LED & Red Lens with Red Diffuser
SPDT ON-(ON) Circuit
Straight PC Terminals

ORDERING EXAMPLE

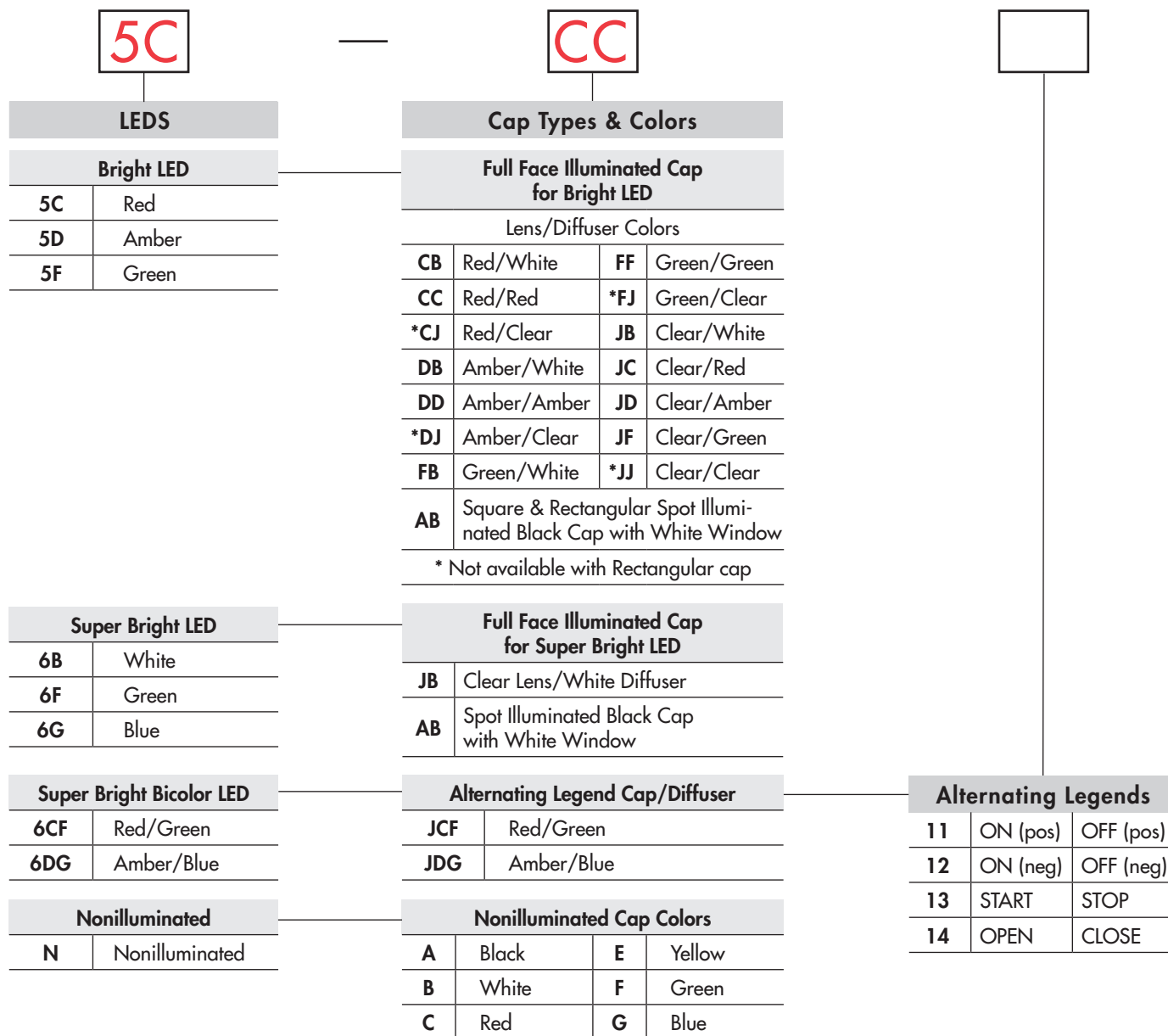

Part Numbers for Alternating Legends							
Square Alternating Legends				Rectangular Alternating Legends			
Color	Part Number	Color	Part Number	Color	Part Number	Color	Part Number
Red/Green	AT9450CF11	Amber/Blue	AT9450DG11	Red/Green	AT9451CF11	Amber/Blue	AT9451DG11
	AT9450CF12		AT9450DG12		AT9451CF12		AT9451DG12
	AT9450CF13		AT9450DG13		AT9451CF13		AT9451DG13
	AT9450CF14		AT9450DG14		AT9451CF14		AT9451DG14

Refer to Ordering Table for Alternating Legend that corresponds with last 2 digits of part number.

Toggles

Rockers

Pushbuttons

Illuminated PB

Programmable

Keylocks

Rotaries

Slides

Tactiles

Tilt

Touch

Indicators

Accessories

Supplement

POLES & CIRCUITS

Pole	Model	Plunger Position () = Momentary		Connected Terminals		Throw & Switch/Lamp Schematics
		Normal	Down	Normal	Down	
SP	UB15 *UB16	ON ON	(ON) ON	1-3 1-2	1-2	SPDT
DP	UB25 *UB26	ON ON	(ON) ON	1-3 4-6 1-2 4-5	1-2 4-5	DPDT

* When in latchdown position for the alternate circuit, cap position is .039" (1.0mm) above the housing.

MOUNTING TYPES & SHAPES

PCB Mounting

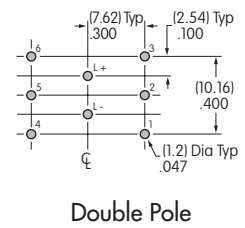
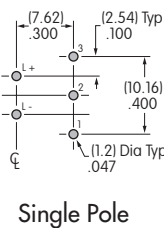
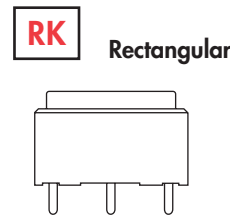
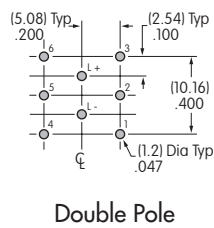
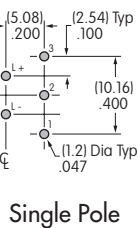

Snap-in Mounting (Solder Lug)

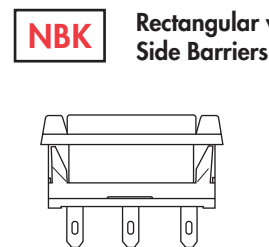
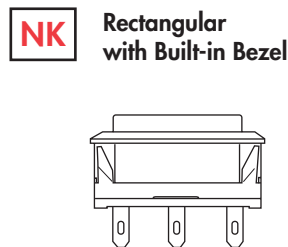
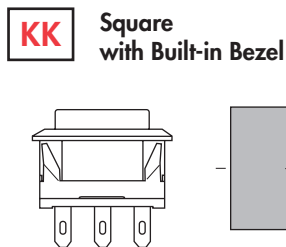

Snap-in Mounting with Solder Lug terminals is the standard combination. Panel Thickness: .039 ~ .126" (1.0 ~ 3.2mm)

CONTACT MATERIALS & RATINGS



Silver Contacts

Power Level

5A @ 125V AC & 250V AC



Gold Contacts

Logic Level

0.4VA maximum @ 28V AC/DC maximum

Complete explanation of operating range in Supplement section.

TERMINALS



Solder Lug

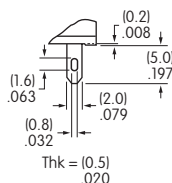

Straight PC

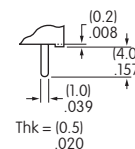

BRIGHT & SUPER BRIGHT LED COLORS & SPECIFICATIONS

The electrical specifications shown are determined at a basic temperature of 25°C. LED circuit is isolated and requires external power source. Polarity marks are on bottom of switch. If the source voltage exceeds the rated voltage, a ballast resistor is required. Resistor value can be calculated by using the formula in the Supplement section. LED is an integral part of switch and not available separately.

Super Bright LEDs are Electrostatic Sensitive		Bright			Super Bright			Unit
		5C	5D	5F	6B	6F	6G	
Color		Red	Amber	Green	White	Green	Blue	
Maximum Forward Current	I_{FM}	30	30	25	20	30	30	mA
Typical Forward Current	I_F	20	20	20	15	20	20	mA
Forward Voltage	V_F	1.85	2.0	2.1	3.3	3.2	2.9	V
Maximum Reverse Voltage	V_{RM}	5	5	5	5	5	5	V
Current Reduction Rate Above 25°C	ΔI_F	0.40	0.42	0.46	0.25	0.40	0.33	mA/°C
Ambient Temperature Range		-25° ~ +50°C			-25° ~ +50°C			

N No Lamp

CAP TYPES & COLOR COMBINATIONS

Full Face Illuminated Cap for Bright LED & Super Bright Single Color LED

Lens/Diffuser

Colors Available for Square Cap:

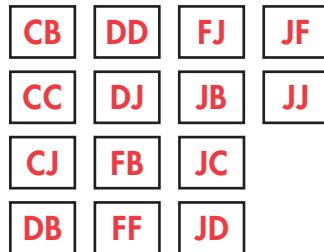

AT4074 Lens

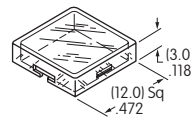

AT4075 Diffuser

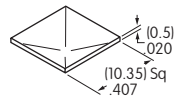

Lens & Diffuser Material: Polycarbonate

Lens/Diffuser

Colors Available for Rectangular Cap:

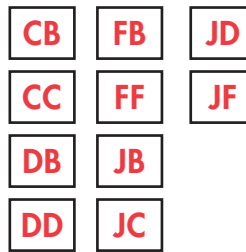

AT4117 Lens

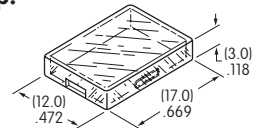

AT4118 Diffuser

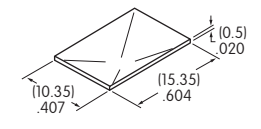

Lens Finish: Glossy

Diffuser Finish: Textured

Spot Illuminated Caps for Bright & Super Bright LEDs

Cap/Window Colors Available:

AB Black Cap with Translucent White Window for LED Display

Material: Polycarbonate

AT4119 Square for Bright and Super Bright LED

Finish: Matte

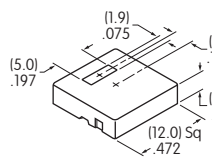

AT4120 Rectangular for Bright and Super Bright LED

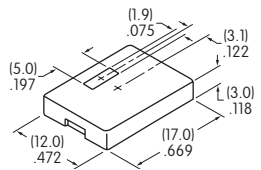

Full Face Illuminated Caps for Super Bright Bicolor LED

JB

AT4074 Square Lens

AT4188 Square Diffuser

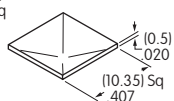
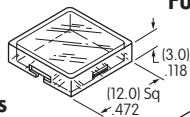

Lens & Diffuser Material: Polycarbonate

AT4117 Rectangular Lens

AT4189 Rectangular Diffuser

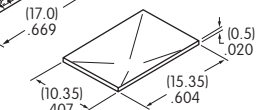
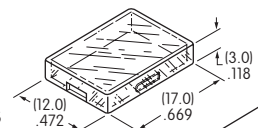

Lens Finish: Glossy

Diffuser Finish: Textured

Cap Colors Available:



Material: Polycarbonate
Finish: Glossy

Opaque Caps for Nonilluminated

AT4073 Square

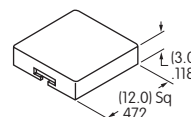

AT4116 Rectangular

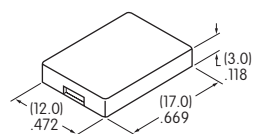

Color Codes: A Black B White C Red D Amber E Yellow F Green G Blue J Clear

Toggles
Rockers
Pushbuttons
Illuminated PB
Programmable
Keylocks
Rotaries
Slides
Tactiles
Tilt
Touch
Indicators
Accessories
Supplement

SUPER BRIGHT BICOLOR LEDS FOR ALTERNATING LEGENDS

The electrical specifications shown are determined at a basic temperature of 25°C. LED circuit is isolated and requires external power source. Polarity marks are on bottom of switch. If the source voltage exceeds the rated voltage, a ballast resistor is required. Resistor value can be calculated by using the formula in the Supplement section. LED is an integral part of switch and not available separately.

Electrical Specifications for Super Bright Bicolor LEDs

Super Bright LEDs are Electrostatic Sensitive		6CF Red/Green		6DG Amber/Blue		Unit
		Color	Red	Green	Amber	
Maximum Forward Current	I_{FM}	* 30	* 30	* 30	* 30	mA
Typical Forward Current	I_F	20	20	20	20	mA
Forward Voltage	V_F	2.3	3.2	2.1	3.0	V
Maximum Reverse Voltage	V_{RM}	4	4	4	4	V
Current Reduction Rate Above 25°C	ΔI_F	0.33	0.33	0.33	0.33	mA/°C
Ambient Temperature Range		-25° ~ +50°		-25° ~ +50°		°C

* Value applies to single color illumination for either Red or Green or Amber or Blue. When both colors are illuminated simultaneously, the sum of the currents should not exceed the smallest value of the maximum forward current.

Super Bright Bicolor Red/Green LED with 2 elements

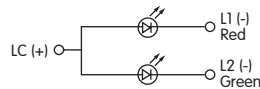

Super Bright Bicolor Amber/Blue LED with 2 elements

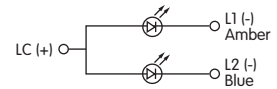

Alternating Legend Caps for Super Bright Bicolor LED

JCF **JDG**

AT4074 12.0mm Square Flat Cap

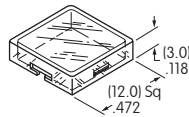

AT9450 Square Legend Insert



AT4188 Square Diffuser



JCF **JDG**

AT4117 12.0mm x 17.0mm Rectangular Flat Cap

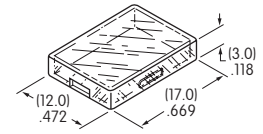

AT9451 Rectangular Legend Insert



AT4189 Rectangular Diffuser

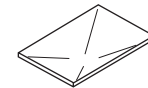

Lens & Diffuser Material: Polycarbonate Legend Insert Material: Polyethylene Terephthalate (PET)

Lens Finish: Glossy Diffuser Finish: Textured

Standard Alternating Legend Pairs

11

ON OFF

Green/Red or Blue/Amber

12

ON OFF

Green/Red or Blue/Amber

13

START STOP

Green/Red or Blue/Amber

14

OPEN CLOSE

Green/Red or Blue/Amber

Cap illumination is alternating Green/Red or Blue/Amber; legend text is black.
Contact factory for other Alternating Legends.

Legend illustrations are approximate representations of the actual characters on the filters.

TYPICAL SWITCH DIMENSIONS

Single & Double Pole

Square • PCB Mount

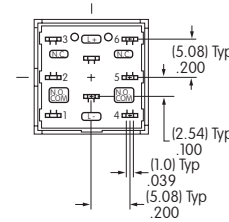
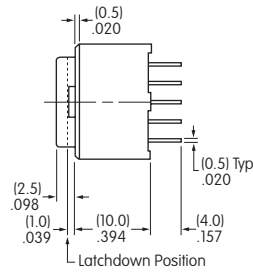
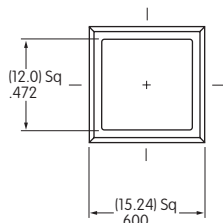

Single pole models do not have terminals 4, 5, & 6.

UB15SKG035C-CB

Single & Double Pole

Rectangular • PCB Mount

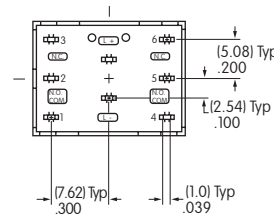
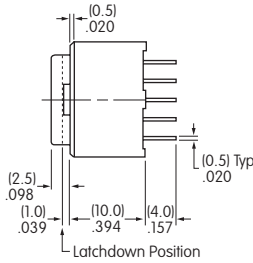
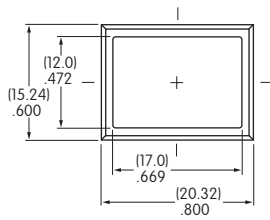

Single pole models do not have terminals 4, 5, & 6.

UB26RKG035D-DD

Single & Double Pole

Square • Snap-in Mount • Built-in Bezel

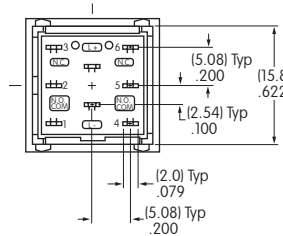
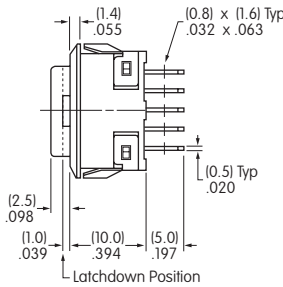
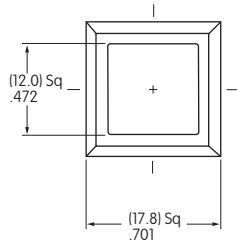

Single pole models do not have terminals 4, 5, & 6.

UB25KKW015C-CB

Single & Double Pole

Rectangular • Snap-in Mount • Built-in Bezel

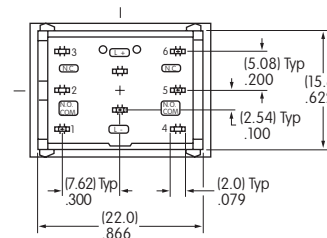
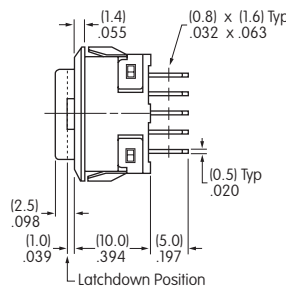
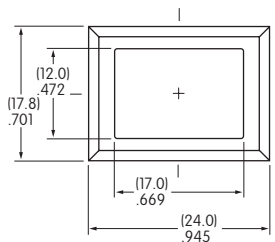

Single pole models do not have terminals 4, 5, & 6.

UB26NKW015F-FF

Single & Double Pole

Rectangular • Snap-in Mount • Built-in Side Barriers

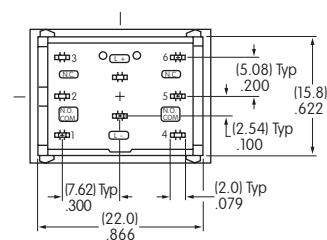
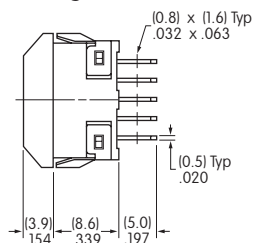
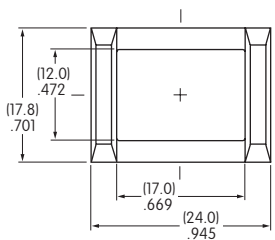

Single pole models do not have terminals 4, 5, & 6.

UB25NBKW015F-FB

TYPICAL SWITCH DIMENSIONS

Square • PCB Mount

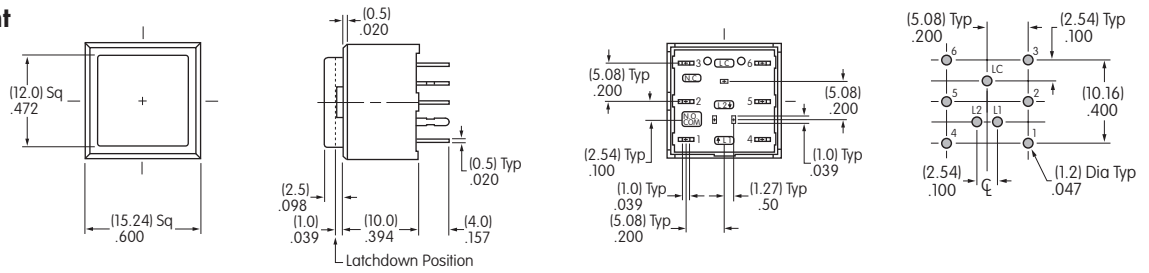

UB25SKG036DG-JDG11

Single pole models do not have terminals 4, 5, & 6.

Square • Snap-in Mount • Built-in Bezel

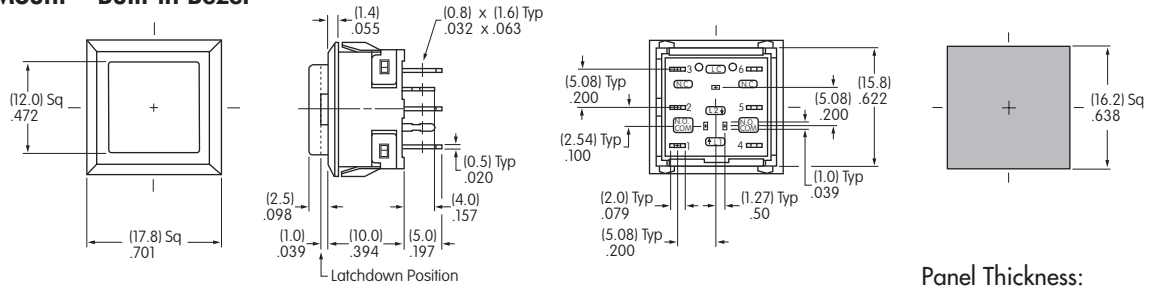

UB25KKW016DG-JDG11

Single pole models do not have terminals 4, 5, & 6.

Panel Thickness:
(1.0 ~ 3.2mm) .039 ~ .126"

Rectangular • PCB Mount

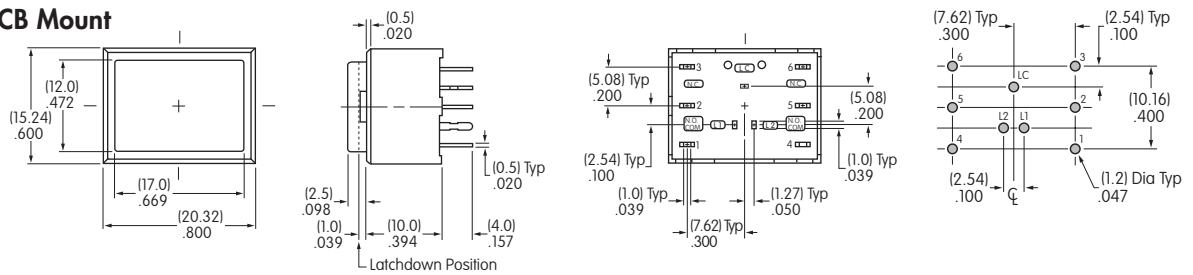

UB25RKG036DG-JDG11

Single pole models do not have terminals 4, 5, & 6.

Rectangular • Snap-in Mount • Built-in Bezel

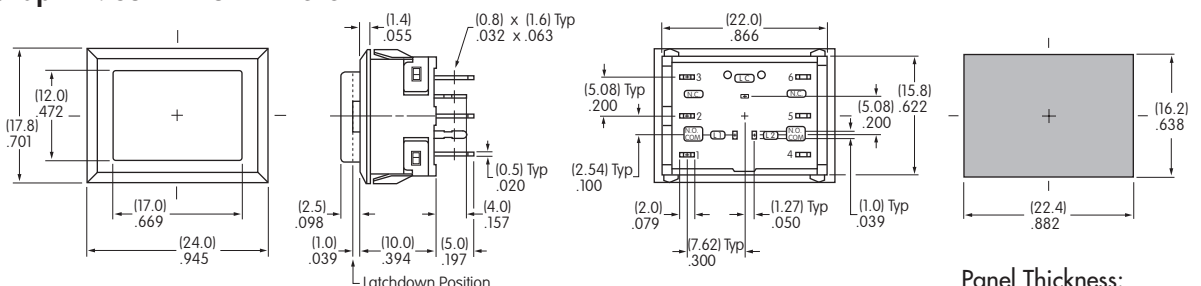

UB26NKW016DG-JDG11

Single pole models do not have terminals 4, 5, & 6.

Panel Thickness:
(1.0 ~ 3.2mm) .039 ~ .126"

Rectangular • Snap-in Mount • Built-in Side Barriers

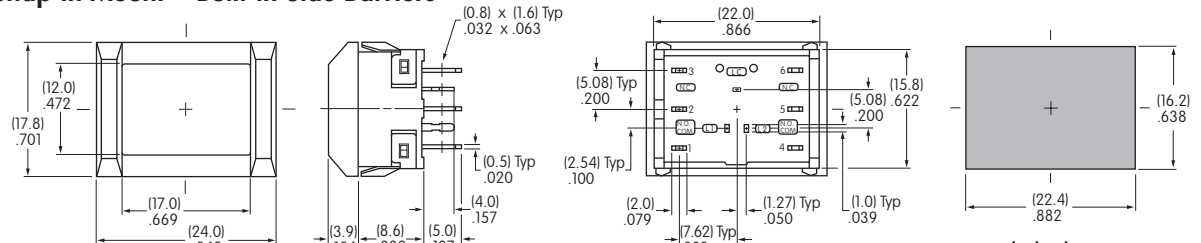

UB26NBKW016DG-JDG11

Single pole models do not have terminals 4, 5, & 6.

Panel Thickness:
(1.0 ~ 3.2mm) .039 ~ .126"

Toggles
Rockers
Pushbuttons
Illuminated PB
Programmable
Keylocks
Rotaries
Slides
Tactiles
Tilt
Touch
Indicators
Accessories
Supplement

OPTIONAL ACCESSORIES

Spring Loaded Protective Guard for Snap-in Mounting of Square PCB Model

AT4173 Square Protective Guard/ Snap-in Frame

Opens 180°
Closes automatically

Materials:
Cover: Clear Polycarbonate
Base: Black Polyamide
Coil Spring: Stainless Steel

Recommended Panel Thickness:
.039" ~ .126"
(1.0mm ~ 3.2mm)

Recommended Panel-to-PCB Range:
.354" ~ .433"
(9.0mm ~ 11.0mm)

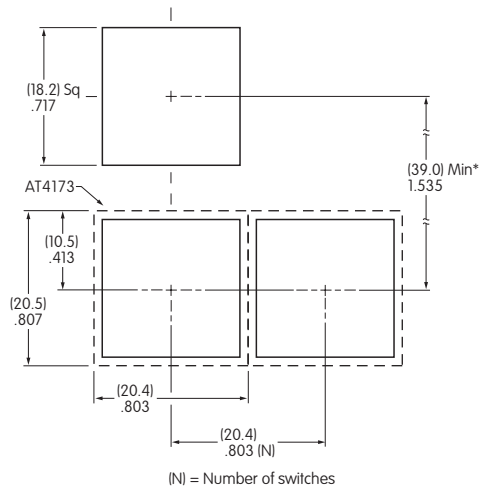
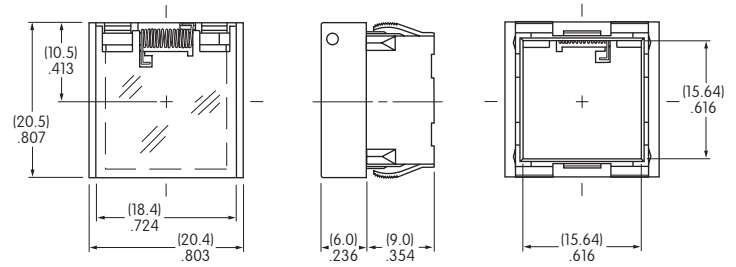
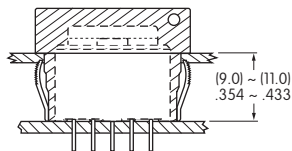

(N) = Number of switches
* Minimum dimension allows opening of cover to 180°

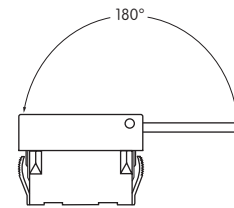

Installation

- 1 Install switch onto PC board.
- 2 Snap protective guard into panel.
- 3 Join the two assemblies.

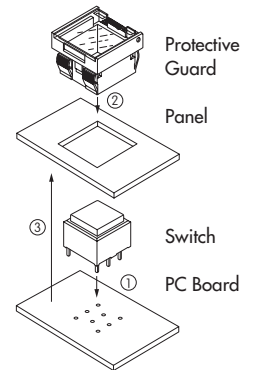

Spring Loaded Protective Guard for Square Snap-in Model

AT4171 Square Protective Guard

Opens 180°
Closes automatically

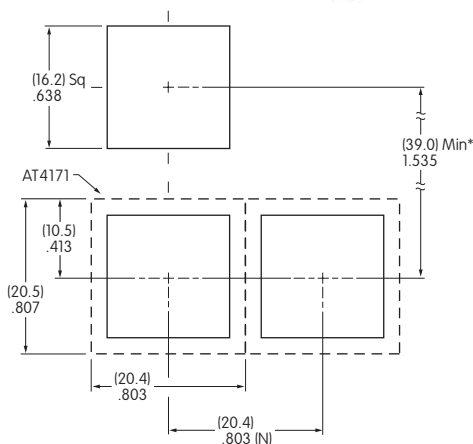
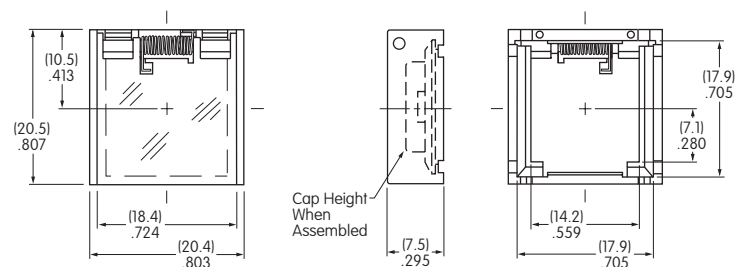

(N) = Number of switches * Minimum dimension allows opening of cover to 180°

Materials:
Cover: Clear Polycarbonate
Base: Black GFR Polyamide
Coil Spring: Stainless Steel

Recommended Panel Thickness:
.039" ~ .106" (1.0mm ~ 2.7mm)

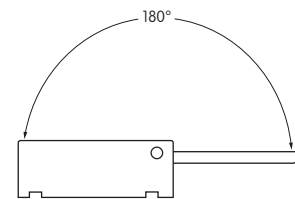

OPTIONAL ACCESSORIES

Spring Loaded Protective Guard for Snap-in Mounting of Rectangular PCB Model

AT4174 Rectangular Protective Guard/ Snap-in Frame



Opens 180°
Closes automatically

Materials:

Cover: Clear Polycarbonate
Base: Black Polyamide
Coil Spring: Stainless Steel

**Recommended
Panel Thickness:**
.039" ~ .126"
(1.0mm ~ 3.2mm)

**Recommended
Panel-to-PCB Range:**
.354" ~ .433"
(9.0mm ~ 11.0mm)

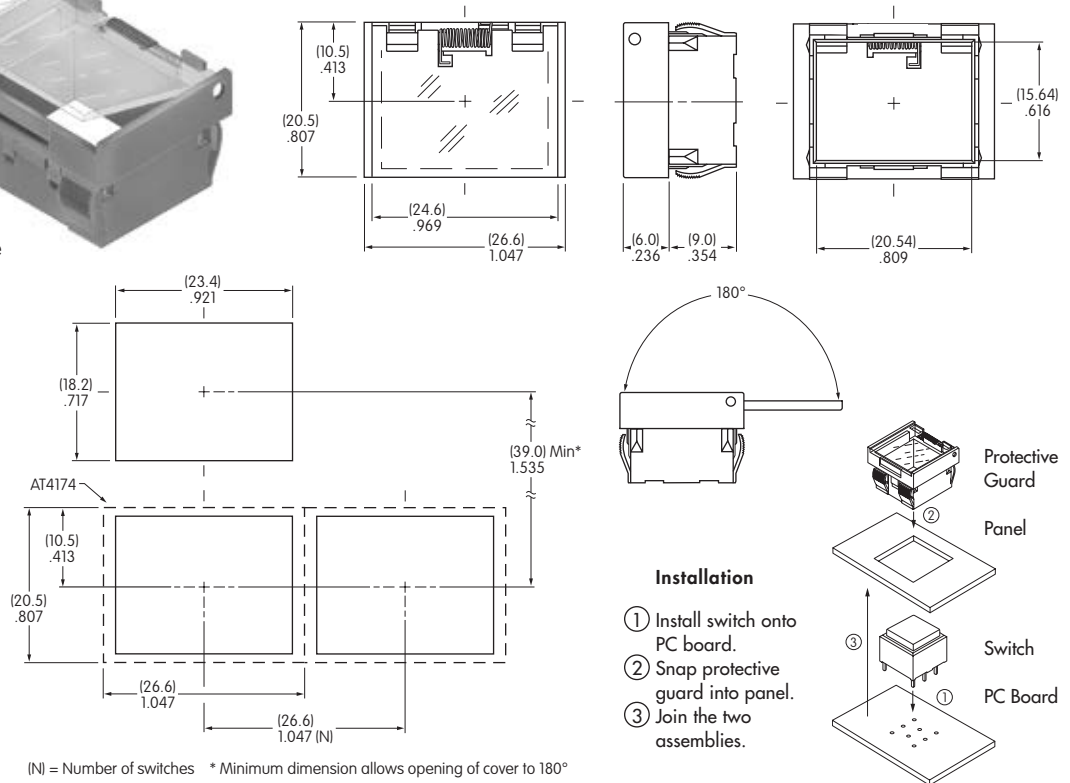
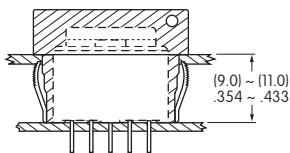

(N) = Number of switches * Minimum dimension allows opening of cover to 180°

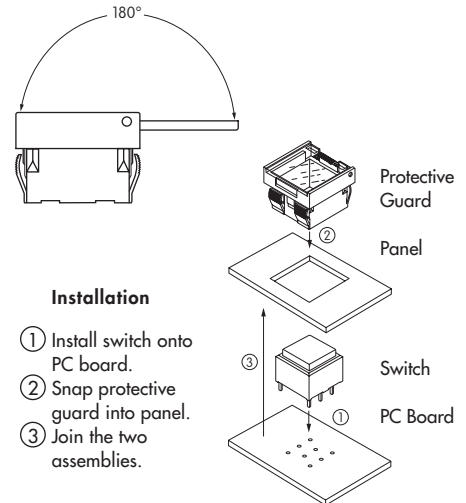

Installation

- 1 Install switch onto PC board.
- 2 Snap protective guard into panel.
- 3 Join the two assemblies.

Spring Loaded Protective Guard for Rectangular Snap-in Model

AT4172 Rectangular Protective Guard



Opens 180°
Closes automatically

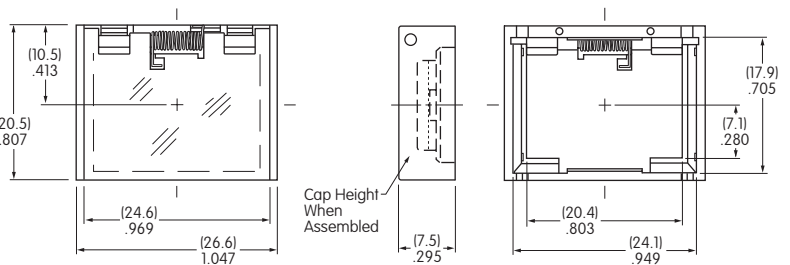

Materials:

Cover: Clear Polycarbonate
Base: Black GFR Polyamide
Coil Spring: Stainless Steel

Recommended Panel Thickness:
.039" ~ .106" (1.0mm ~ 2.7mm)

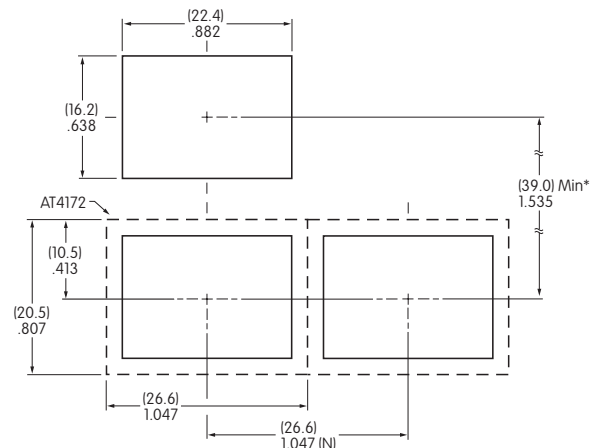
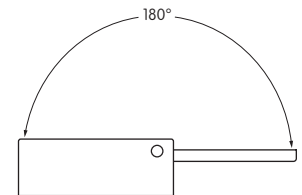

(N) = Number of switches * Minimum dimension allows opening of cover to 180°

OPTIONAL ACCESSORIES

AT4001
Square

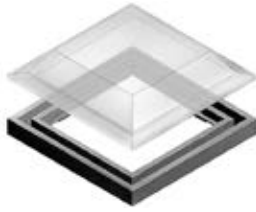

Only for use with KK mounting type

AT4011
Rectangular

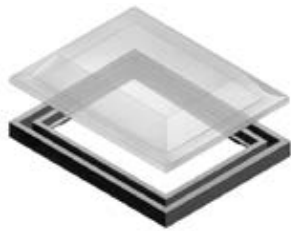

Only for use with NK mounting type

Dust Covers

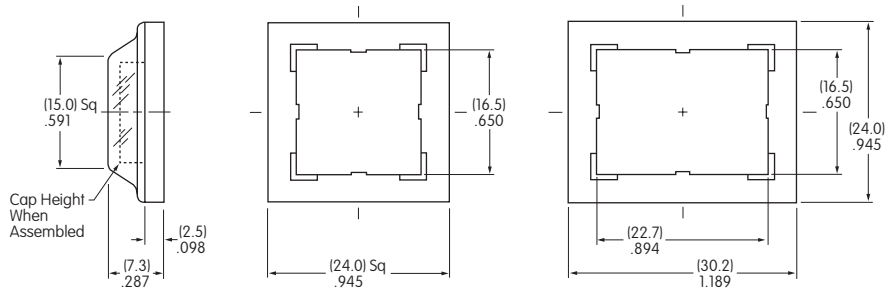

Materials:

PVC with polyethylene gasket
(PVC loses pliability below 0°C (32°F).)

Recommended Panel Thickness: .039" ~ .098" (1.0mm ~ 2.5mm)

LEGENDS

NKK Switches can provide custom legends for caps. Contact factory for more information.

Suggested Printable Area for UB Lens & Film Insert

Recommended Methods: Laser Etch on clear lens, Screen Print or Pad Print on lens;
Laser Print on film insert.

Square Cap



Rectangular Cap

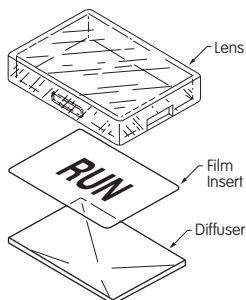

Shaded areas are printable areas.

Lens

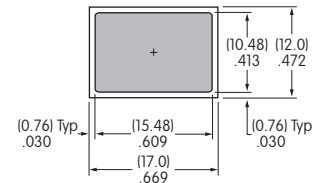
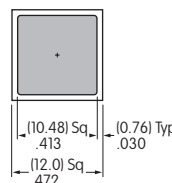

Film Insert

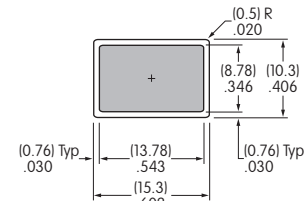
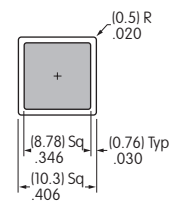

Film Insert: Clear Polyester 0.15mm max. thickness

Toggles
Rockers
Pushbuttons
Illuminated PB
Programmable
Keylocks
Rotaries
Slides
Tactiles
Tilt
Touch
Indicators
Accessories
Supplement

Mouser Electronics

Authorized Distributor

Click to View Pricing, Inventory, Delivery & Lifecycle Information:

NKK Switches:

[UB15KKW01N](#) [UB16KKG01N-C](#) [UB16KKG01N-F](#) [UB16KKG01N-B](#) [UB16KKG01N-E](#) [UB16KKG01N-A](#)
[UB15KKW01N-A](#) [UB15KKW01N-F](#) [UB15KKW01N-B](#) [UB15KKW01N-E](#) [UB15KKW01N-C](#) [UB15KKG01N-C](#)
[UB15KKG01N-F](#) [UB15KKG01N-A](#) [UB15KKG01N-E](#) [UB15KKG01N-B](#) [UB15SKG03N](#) [UB15KKG01N](#) [UB16KKG01N](#)
[UB16KKW01N-E](#) [UB16KKW01N-F](#) [UB16KKW01N-C](#) [UB16KKW01N-B](#) [UB16KKW01N-A](#) [UB15SKW03N](#)
[UB16KKW01N](#) [UB16SKW03N](#) [UB15SKG03N-A](#) [UB15SKG03N-C](#) [UB16SKG03N](#) [UB16NBKW01N-A](#) [UB15KKG01N-](#)
[G](#) [UB15KKG01N-JB](#) [UB15KKG01N-JJ](#) [UB15NBKG01N-A](#) [UB15NBKG01N-B](#) [UB15NBKG01N-F](#) [UB15NBKG01N-G](#)
[UB15NBKG01N-JB](#) [UB15NBKW01N](#) [UB15NBKW01N-A](#) [UB15NBKW01N-B](#) [UB15NBKW01N-C](#) [UB15NBKW01N-F](#)
[UB15NBKW01N-G](#) [UB15NKG01N-A](#) [UB15NKG01N-B](#) [UB15NKG01N-E](#) [UB15NKG01N-F](#) [UB15NKG01N-JB](#)
[UB15NKW01N](#) [UB15NKW01N-A](#) [UB15NKW01N-B](#) [UB15NKW01N-C](#) [UB15RKG03N-A](#) [UB15RKG03N-F](#)
[UB15RKG03N-JB](#) [UB15RKW03N-A](#) [UB15SKG03N-B](#) [UB15SKG03N-E](#) [UB15SKG03N-F](#) [UB15SKG03N-G](#)
[UB15SKW03N-A](#) [UB15SKW03N-B](#) [UB15SKW03N-C](#) [UB16KKW01N-G](#) [UB16NBKG01N-A](#) [UB16NBKG01N-B](#)
[UB16NBKW01N-B](#) [UB16NBKW01N-F](#) [UB16NBKW01N-G](#) [UB16RKG03N-C](#) [UB16RKW03N-A](#) [UB16RKW03N-JB](#)
[UB16SKG03N-A](#) [UB16SKG03N-C](#) [UB16SKG03N-G](#) [UB16SKW03N-A](#) [UB16SKW03N-G](#) [UB16NBKG01N-F](#)
[UB15NKW01N-F](#) [UB16SKW03N-E](#) [UB15NBKG01N](#) [UB15RKG03N](#) [UB15RKW03N](#) [UB16NBKG01N](#) [UB16NKW01N](#)
[UB16RKW03N](#) [UB15NKBG01N-A](#) [UB15KKG01N-JF](#) [UB15NKW01N-E](#) [UB15RKG03N-B](#) [UB15SKW03N-E](#)
[UB16SKW03N-B](#) [UB16SKW03N-F](#) [UB15NKG01N-C](#) [UB25NKG01N-B](#) [UB15KKG01N-F/AT499](#) [UB25NBKW01N-F](#)
[UB26NKW01N-A](#)