

FEATURES

- Patents protected
- Lower profile
- UL62368-1 recognised
- ANSI/AAMI ES60601-1, 2 MOOP, 1MOPP recognised
- 4.2kVDC isolation “Hi Pot Test”
- Substrate embedded transformer
- Automated manufacture
- Industry standard footprint
- Short circuit protection³
- Halogen free

PRODUCT OVERVIEW

The NXJ1 series is a new range of low cost, lower profile, fully automated manufacture surface mount DC-DC converters. The NXJ1 series automated manufacturing process with substrate Embedded Transformer, offers increased product reliability and repeatability of performance in a halogen free, iLGA inspectable package. The NXJ1 series, industry standard footprint is compatible with existing designs.

The NXJ1 series has a MSL rating 2, and is compatible with a peak reflow solder temperature of 260°C as per J-STD-020.



For full details go to
www.murata.com/en-global/products/power/rohs



SELECTION GUIDE

Order Code ¹	Nominal Input Voltage	Output Voltage	Rated Input Current	Output Current	Load Regulation (Typ)	Load Regulation (Max)	Output Ripple & Noise (Typ)	Output Ripple & Noise (Max)	Efficiency (Min)	Efficiency (Typ)	Switching Frequency (Typ)	Isolation Capacitance	MTTF ²
	V	V	mA	mA	%	%	mVp-p	mVp-p	%	%	kHz	pF	kHrs
NXJ1S0303MC	3.3	3.3	400	303	10.5	11.5	75	105	66	69.5	80	2	2430
NXJ1S0305MC	3.3	5	400	200	8.5	10	25	45	70	72	90	2.5	3065
NXJ1S0505MC	5	5	250	200	12	13.5	20	50	69	73.5	205	2.5	1988
NXJ1S1205MC	12	5	110	200	6	8.5	22	45	69	72	110	2.5	2244
NXJ1S1212MC	12	12	115	83	4.5	5	15	40	65	71	125	2.5	3473
NXJ1S1215MC	12	15	120	67	4	5	15	40	67	71	135	2.5	3208

INPUT CHARACTERISTICS

Parameter	Conditions	Min.	Typ.	Max.	Units
Voltage range	Continuous operation, 3V input types	2.97	3.3	3.63	V
	Continuous operation, 5V input types	4.5	5.0	5.5	
	Continuous operation, 12V input types	10.8	12	13.2	
Input reflected ripple current	3V input		6		mA p-p
	5V input		2		
	12V input		2		

ISOLATION CHARACTERISTICS

Parameter	Conditions	Min.	Typ.	Max.	Units
Isolation voltage	Production tested for 1 second	4200			VDC
	Qualification tested for 1 minute	4200			
Resistance	Viso= 1000VDC	10			GΩ

OUTPUT CHARACTERISTICS

Parameter	Conditions	Min.	Typ.	Max.	Units
Rated power	T _A =-40°C to 85°C			1.0	W
Voltage set point accuracy	See tolerance envelope				
Line regulation	High V _{IN} to low V _{IN}	0505 variant	1.15	1.2	%/%
		All other variants	1.1	1.2	

TEMPERATURE CHARACTERISTICS

Parameter	Conditions	Min.	Typ.	Max.	Units
Specification ⁴	NXJ1S0505MC from date code K1725	-40		110	°C
	All other output types	-40		85	
Storage		-50		125	
Product temperature rise above ambient	All output types		16		
Cooling	Free air convection				

ABSOLUTE MAXIMUM RATINGS

Input voltage V _{IN} , NXJ1S03 types	5.5V
Input voltage V _{IN} , NXJ1S05 types	7V
Input voltage V _{IN} , NXJ1S12 types	15V

1. Components are supplied in tape and reel packaging, please refer to package specification section. Orderable part numbers are NXJ1SXXXXMC-R7 (180 pieces per reel), or NXJ1SXXXXMC-R13 (800 pieces per reel).

2. Calculated using MIL-HDBK-217 FN2 calculation model with nominal input voltage at full load.

3. Please refer to short circuit application notes.

4. Please refer to temperature derating section.

All specifications typical at T_A=25°C, nominal input voltage and rated output current unless otherwise specified.

TECHNICAL NOTES**ISOLATION VOLTAGE**

'Hi Pot Test', 'Flash Tested', 'Withstand Voltage', 'Proof Voltage', 'Dielectric Withstand Voltage' & 'Isolation Test Voltage' are all terms that relate to the same thing, a test voltage, applied for a specified time, across a component designed to provide electrical isolation, to verify the integrity of that isolation.

Murata Power Solutions NXJ1 series of DC-DC converters are all 100% production tested at 4.2kVDC for 1 second and have been qualification tested at 4.2kVDC for 1 minute.

A question commonly asked is, "What is the continuous voltage that can be applied across the part in normal operation?"

The NXJ1 series has been recognised by Underwriters Laboratory, please see safety approval section for more information. When the insulation in the NXJ1 is not used as a safety barrier, i.e. provides functional isolation only, continuous or switched voltages across the barrier in excess of 1kV are sustainable. Long term reliability testing at these voltages continues. Please contact Murata for further information.

REPEATED HIGH-VOLTAGE ISOLATION TESTING

It is well known that repeated high-voltage isolation testing of a barrier component can actually degrade isolation capability, to a lesser or greater degree depending on materials, construction and environment. The NXJ1 series has a PCB embedded isolated transformer, using FR4 as an insulation barrier between primary and secondary windings. While parts can be expected to withstand several times the stated test voltage, the isolation capability does depend on the FR4 insulation properties. Any material, including FR4 is susceptible to eventual chemical degradation when subject to very high applied voltages thus implying that the number of tests should be strictly limited. We therefore strongly advise against repeated high voltage isolation testing, but if it is absolutely required, that the voltage should be reduced by 20% from specified test voltage.

This consideration equally applies to agency recognised parts rated for better than functional isolation where the insulation is always supplemented by a further insulation system of physical spacing or barriers.

SAFETY APPROVAL**ANSI/AAMI ES60601-1**

The NXJ1 series is recognised by Underwriters Laboratory (UL) to ANSI/AAMI ES60601-1 and provides 1 MOPP (Means Of Patient Protection) based upon a working voltage of 250 Vrms max, between input and output.

UL62368-1

The NXJ1 series has been recognised by Underwriters Laboratory (UL) to UL62368-1 for reinforced insulation to a working voltage of 200Vrms and for basic insulation to a working voltage of 250Vrms.

Creepage and clearance is 4mm.

FUSING

The NXJ1 Series of converters are not internally fused so to meet the requirements of UL an anti-surge input line fuse should always be used with ratings as defined below.

Input Voltage, 3.3V: 1A

Input Voltage, 5V: 0.5A

Input Voltage, 12V: 0.25A

All fuses should be UL recognised and rated to at least the maximum allowable DC input voltage.

RoHS COMPLIANCE AND MSL INFORMATION

This series is compatible with Pb-Free soldering systems and is also backward compatible with Sn/Pb soldering systems.

The NXJ1 series can be soldered in accordance with J-STD-020 and have a classification temperature of 260°C and moisture sensitivity level 2. The termination finish on this product is Gold with plating thickness 0.12 microns.

For further information please visit www.murata.com/en-global/products/power/rohs

ENVIRONMENTAL VALIDATION TESTING

The following tests have been conducted on this product series, as part of our design verification process. The datasheet characteristics specify user operating conditions for this series, please contact Murata if further information about the tests is required.

Test	Standard	Condition
Temperature cycling	JEDEC JESD22-A104	1000 cycles between two temperature extremes set to achieve -40°C and +105°C. 2 full cycles per hour.
Humidity bias	JEDEC JESD22-A101	1000 hours at 85°C ± 2°C, 85% ± 5% R.H.
Storage life	JEDEC JESD22-A103	1000 hours at 125°C (-0/+10)°C.
MSL	IPC/JEDEC J-STD-020	Bake samples at 125 +5/-0°C for 24 hours minimum before conditioning in the Temperature/Humidity chamber for 168 hours 85°C/60%RH.
Solderability	IPC/ECA J-STD-002. Test A1	Pb-free (Test A1) For lead free solderability the parts are conditioned in a steam ager for 8 hours ±15 min. at a temperature of 93°C ±3°C. Dipped in solder at 245°C ±5°C for 5 (+0/-0.5) seconds
Solder heat (Hand)	MIL-Std 202G, Method 210, Test Condition A	The soldering iron is heated to 350°C ± 10°C and applied to the terminations for a duration of 4 to 5 seconds.
Shock	JEDEC JESD22-B104	5 pulses of 0.5msec duration (±30%), 1500g (±20%) peak acceleration. 6 Planes, total of 30 Pulses.
Vibration	JEDEC JESD22-B103	20Hz to 2 kHz to 20Hz (logarithmic variation) in >4 minutes, x4 in each orientation (i.e. 12 times), 50G peak acceleration. Sinusoidal Vibration.
Solvent Resistance	MIL-STD-883 Method 2015.14	The parts and the bristle portion of the brush are immersed in Isopropanol for a minimum of 1 minute. The parts are brushed 3 times, after the third time the parts are blown dry and inspected.
Solvent cleaning	Resistance to cleaning agents.	Solvent – Novec 71IPA & Topklean EL-20A. Pulsed ultrasonic immersion 45°C- 65°C
ESD	JEDEC JESD22-A114	HBM Testing Standard at 4 stress levels; 1.0kV, 2.0kV, 4.0kV and 8.0kV.

PART NUMBER STRUCTURE

NXJ 1 S XX XX M C -RXX

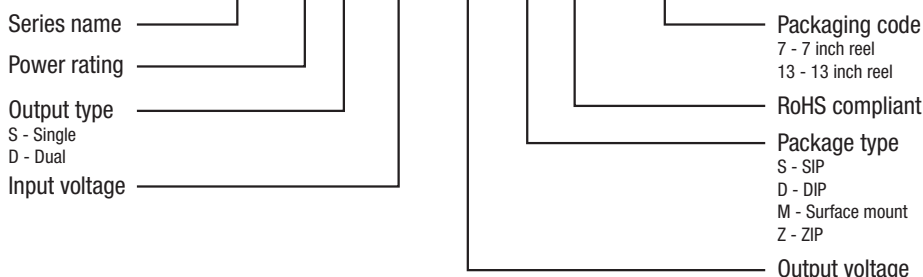

CHARACTERISATION TEST METHODS

Ripple & Noise Characterisation Method

Ripple and noise measurements are performed with the following test configuration.

C1	1µF X7R multilayer ceramic capacitor, voltage rating to be a minimum of 3 times the output voltage of the DC-DC converter
C2	10µF tantalum capacitor, voltage rating to be a minimum of 1.5 times the output voltage of the DC-DC converter with an ESR of less than 100mΩ at 100 kHz
C3	100nF multilayer ceramic capacitor, general purpose
R1	450Ω resistor, carbon film, ±1% tolerance
R2	50Ω BNC termination
T1	3T of the coax cable through a ferrite toroid
RLOAD	Resistive load to the maximum power rating of the DC-DC converter. Connections should be made via twisted wires

Measured values are multiplied by 10 to obtain the specified values.

Differential Mode Noise Test Schematic

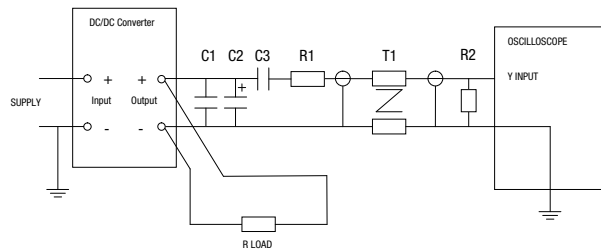

APPLICATION NOTES

Short Circuit Performance

NXJ1 short circuit protection is not continuous and varies with output voltage and temperature as shown in the following graph:

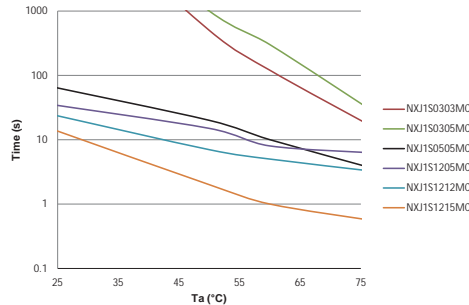

Advisory Notes

The NXJ1 series is not hermetically sealed, customers should ensure that parts are fully dried before input power application.

Minimum Load

The minimum load to meet datasheet specification is 10% of the full rated load across the specified input voltage range. Lower than 10% minimum loading will result in an increase in output voltage, which may rise to typically double the specified output voltage if the output load falls to less than 5%.

Capacitive Loading & Start Up

Typical start up times for this series, with a typical input voltage rise time of 2.2µs with resistive only load, and with added output capacitance of 47µF, are shown in the table below.

Part Number	Resistive Load	Resistive Load and 47µF
	Start-up time (µS)	
NXJ1S0303MC	40	190
NXJ1S0305MC	95	1700
NXJ1S0505MC'	50	1100
NXJ1S1205MC	35	600
NXJ1S1212MC	80	2650
NXJ1S1215MC	100	4000

Typical Start-Up Wave Form

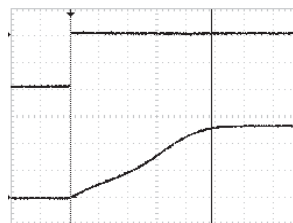

1. The NXJ1S0505MC has been tested to 220µF and will operate within datasheet specifications with an increased start up time, please contact Murata for information about other variants.

Output Ripple Reduction

By using the values of inductance and capacitance stated, the output ripple at the rated load is lowered to 5mV p-p max.

Component selection

Capacitor: It is required that the ESR (Equivalent Series Resistance) should be as low as possible, ceramic types are recommended. The voltage rating should be at least twice (except for 15V output), the rated output voltage of the DC-DC converter.

Inductor: The rated current of the inductor should not be less than that of the output of the DC-DC converter. At the rated current, the DC resistance of the inductor should be such that the voltage drop across the inductor is <2% of the rated voltage of the DC-DC converter. The SRF (Self Resonant Frequency) should be >20MHz.

	Inductor			Capacitor
	L, µH	SMD	Through Hole	C, µF
NXJ1S0303MC	4.7	82472C	11R472C	22
NXJ1S0305MC	10	82103C	11R103C	10
NXJ1S0505MC	10	82103C	11R103C	2.2
NXJ1S1205MC	10	82103C	11R103C	4.7
NXJ1S1212MC	22	82223C	11R223C	4.7
NXJ1S1215MC	22	82223C	11R223C	4.7

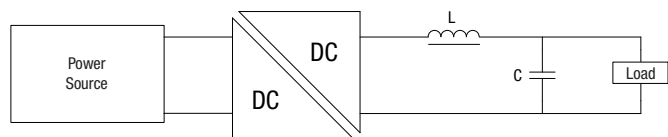

TOLERANCE ENVELOPES

The voltage tolerance envelope shows typical load regulation characteristics for this product series. The tolerance envelope is the maximum output voltage variation due to changes in output loading.

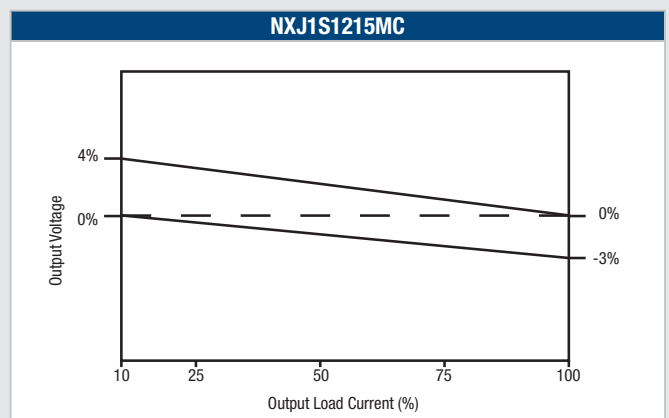
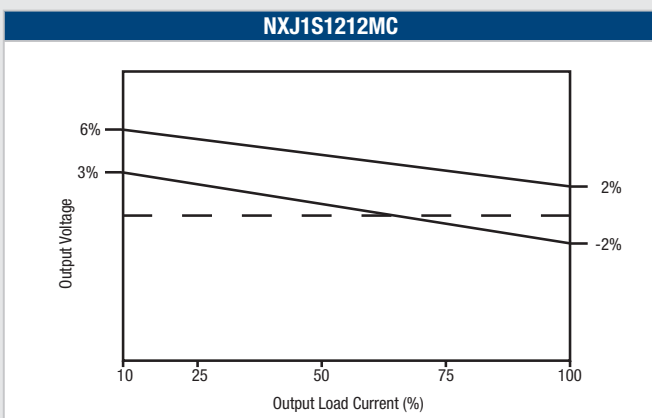
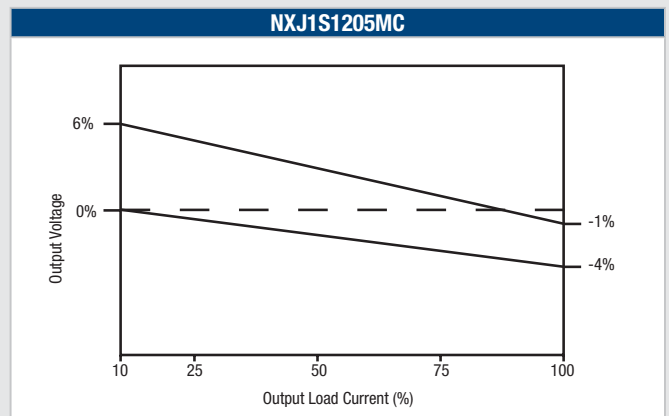
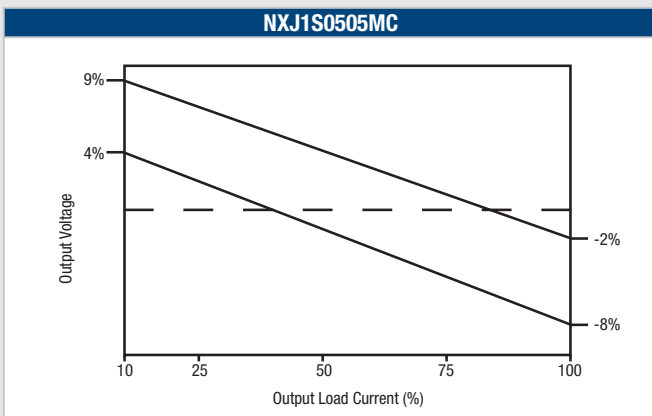
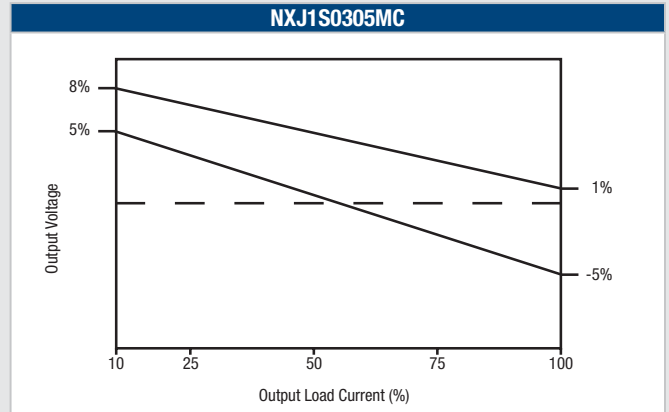
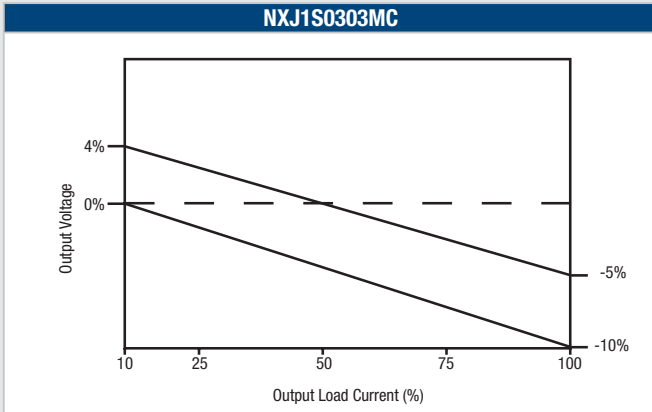

EFFICIENCY VS LOAD

3V Input

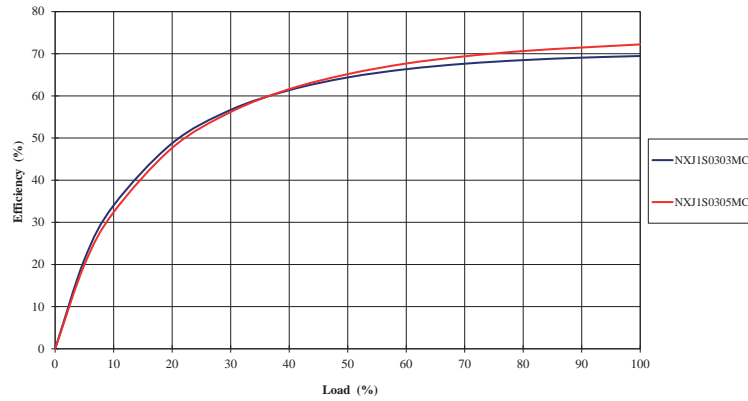

5V Input

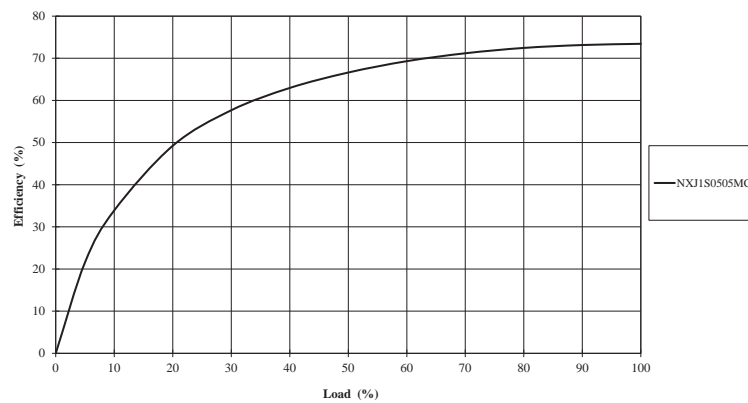

12V Input

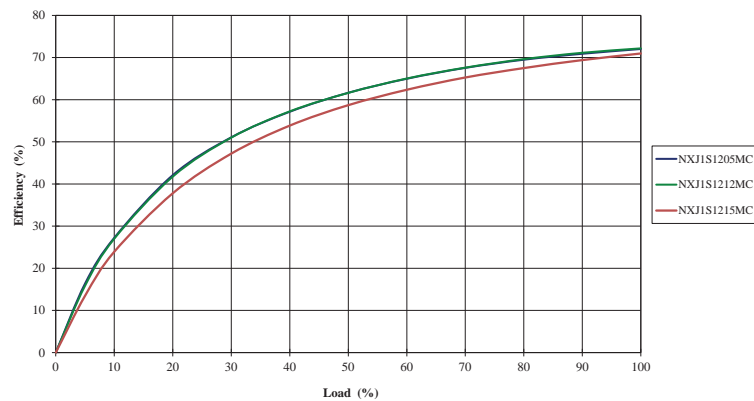

TEMPERATURE DERATING

The derating graphs are based on the following airflow conditions, for a component mounted on a 25mm x 25mm copper covered pcb and are provided for information only. Actual performance in an application is likely to differ from these results, and a customer should evaluate the thermal environment the NXJ1 is used in, to achieve a recommended maximum component surface temperature of 85°C for the NXJ1S0303SC or 105°C for all other variants.

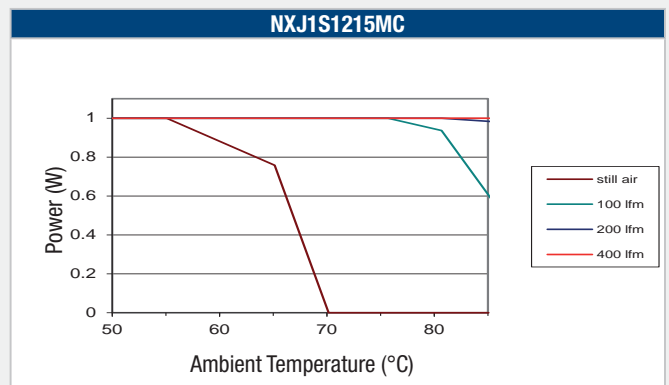
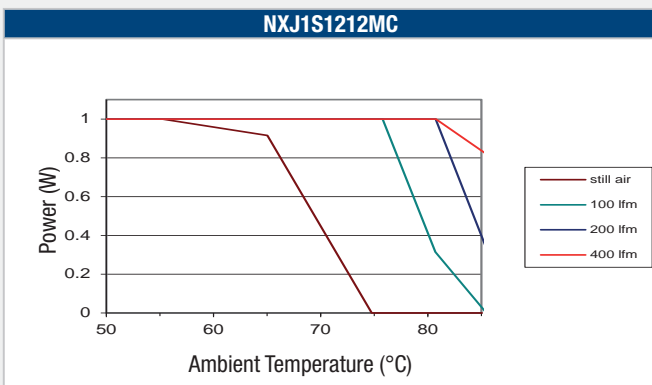
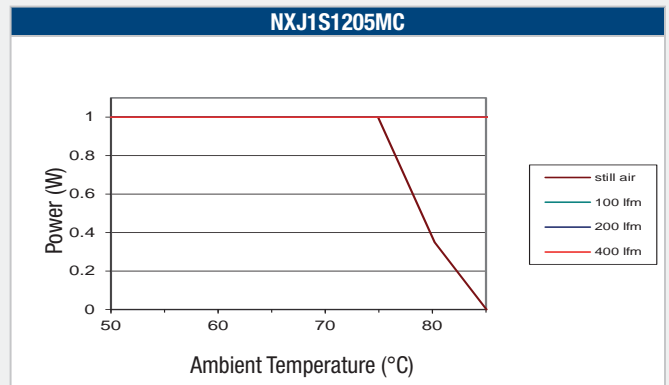
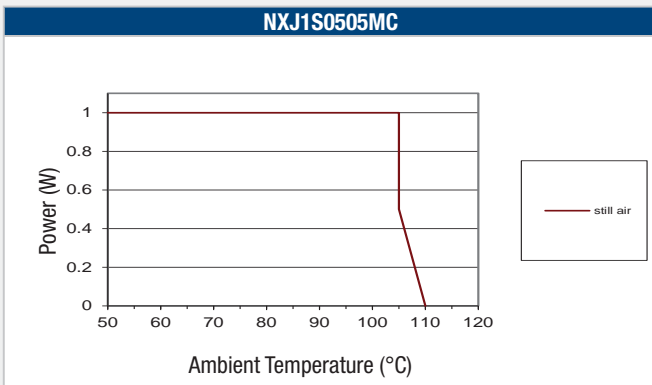
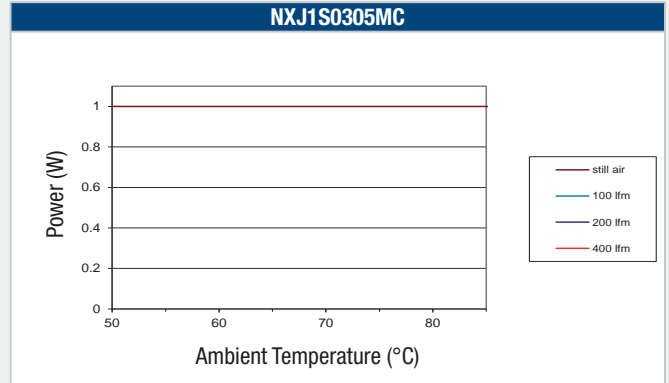
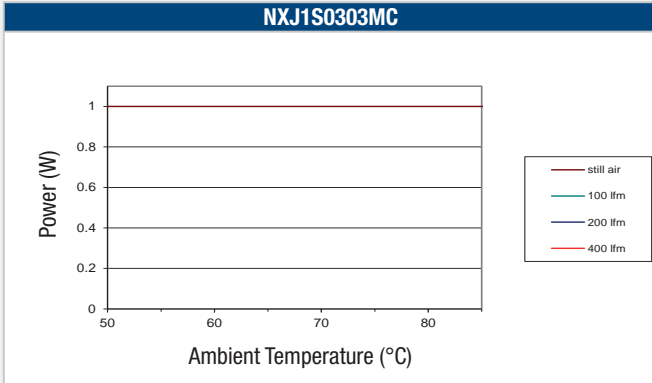

EMC FILTERING AND SPECTRA

FILTERING

The following table shows the additional input capacitor and input inductor typically required to meet EN 55022 Curve A & B CISPR22 Average Limit as shown in the following plots. The following plots show positive and negative average limit and CISPR22 Average Limit A (pink line) and CISPR22 Average Limit B (blue line) adherence limits.

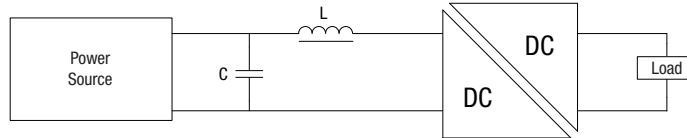

	Inductor			Capacitor	
	L, μ H	SMD	Through Hole	C, μ F	SMD
NXJ1S0303MC	10	84103C	11R103C	22	GRM21BD70J226ME44
NXJ1S0305MC	10	84103C	11R103C	22	GRM21BD70J226ME44
NXJ1S0505MC	4.7	82472C	11R472C	4.7	GRM21BR71A475KA73
NXJ1S1205MC	10	82103C	11R103C	4.7	GRM21BR71C475KA73
NXJ1S1212MC	10	82103C	11R103C	4.7	GRM21BR71C475KA73
NXJ1S1215MC	10	82103C	11R103C	4.7	GRM21BR71C475KA73

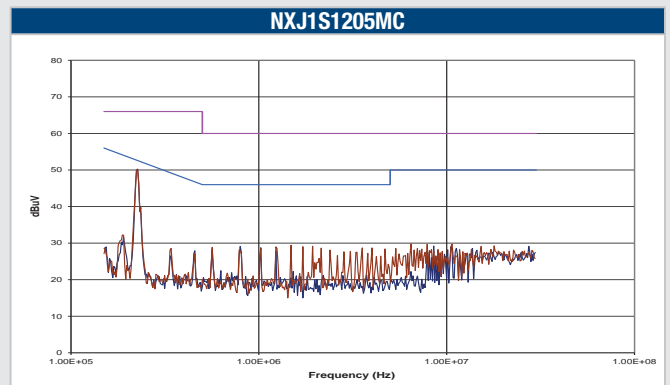
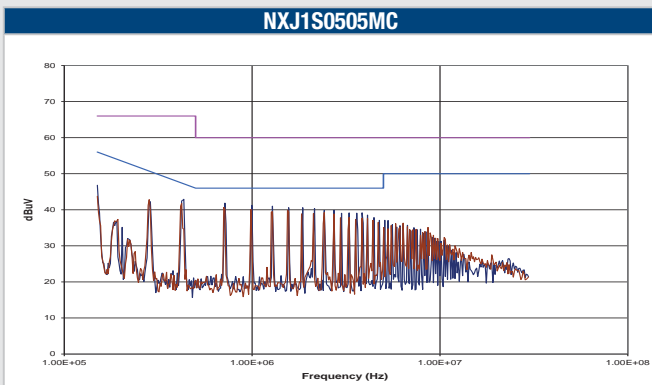
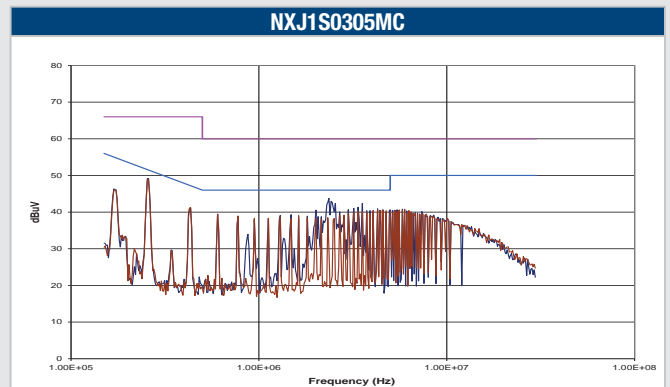
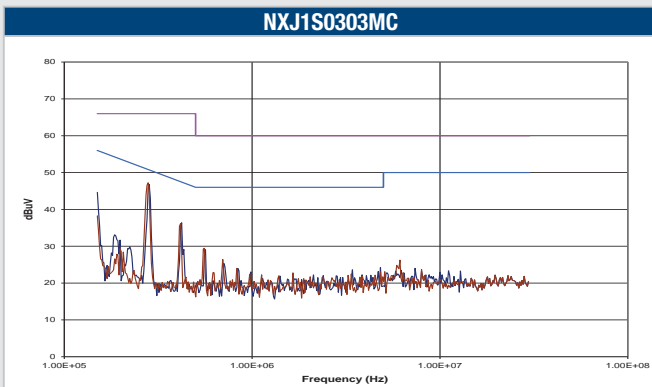

EMC FILTERING AND SPECTRA (Continued)

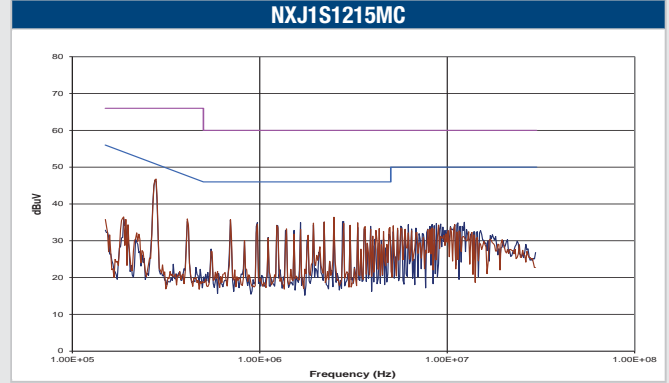
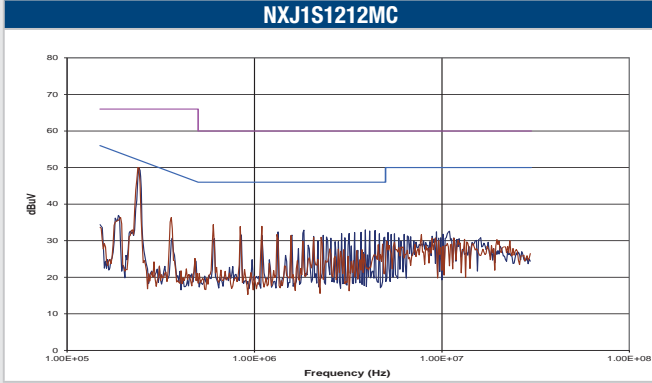

PACKAGE SPECIFICATIONS

Mechanical Dimensions

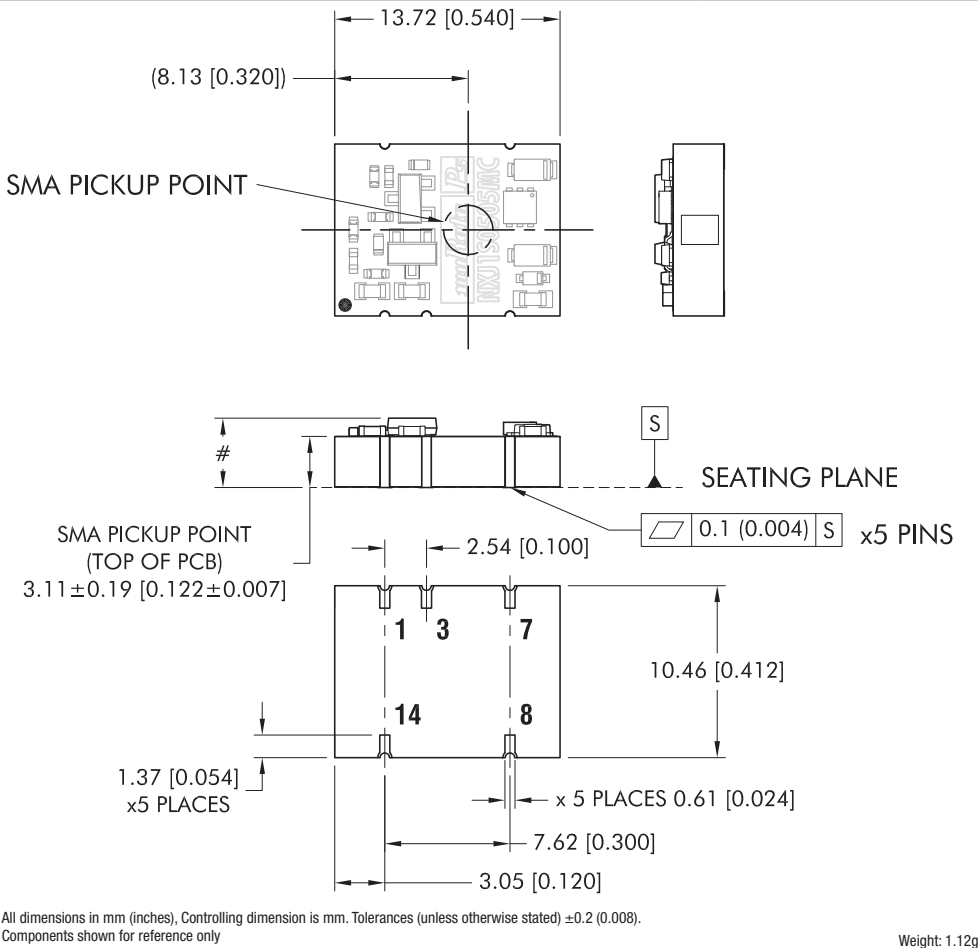

Pin Connections

Pin	Function
1	-Vin
3	+Vin
7	-Vout
8	+Vout
14	NC

NC - No connection.

Dimension Information

Variant	Dim #
NXJ1S0303MC	4.36 \pm 0.35mm
NXJ1S0305MC	[0.172 \pm 0.014]
NXJ1S0505MC	4.16 \pm 0.35mm
NXJ1S1205MC	
NXJ1S1212MC	
NXJ1S1215MC	[0.164 \pm 0.014]

All dimensions in mm (inches), Controlling dimension is mm. Tolerances (unless otherwise stated) ± 0.2 (0.008).

Recommended Footprint Details

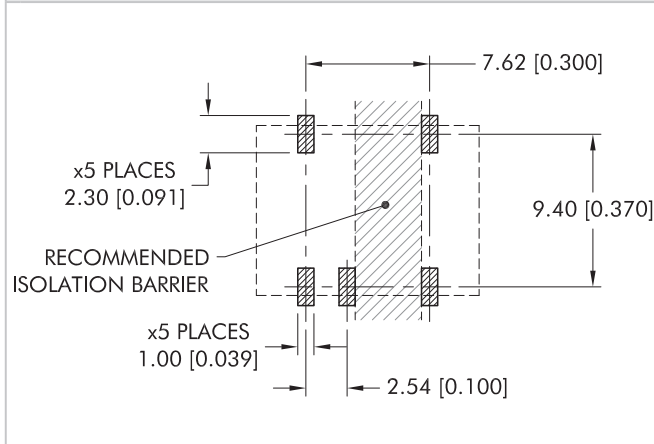

TAPE & REEL SPECIFICATIONS

REEL OUTLINE DIMENSIONS

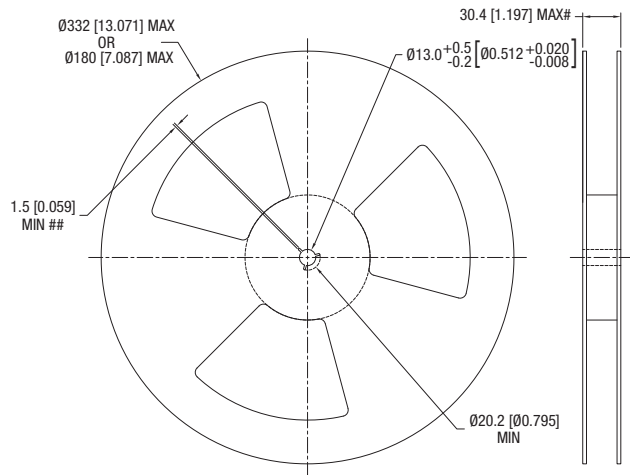

Tape & Reel specifications shall conform with current EIA-481 standard
 Unless otherwise stated all dimensions in mm (inches)
 Controlling dimension is mm
 # Measured at hub
 ## Six equi-spaced slots on 180mm/7" reel

REEL PACKAGING DETAILS

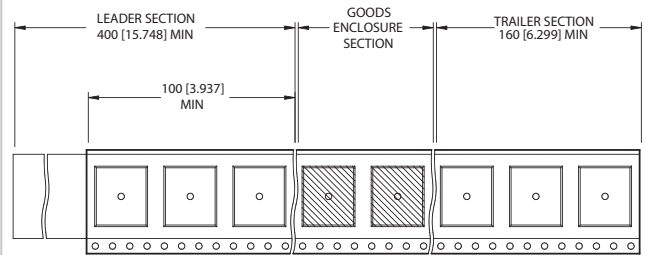

Carrier tape pockets shown are illustrative only - Refer to carrier tape diagram for actual pocket details.
 Reel Quantity: 7" - 180 or 13" - 800

TAPE OUTLINE DIMENSIONS

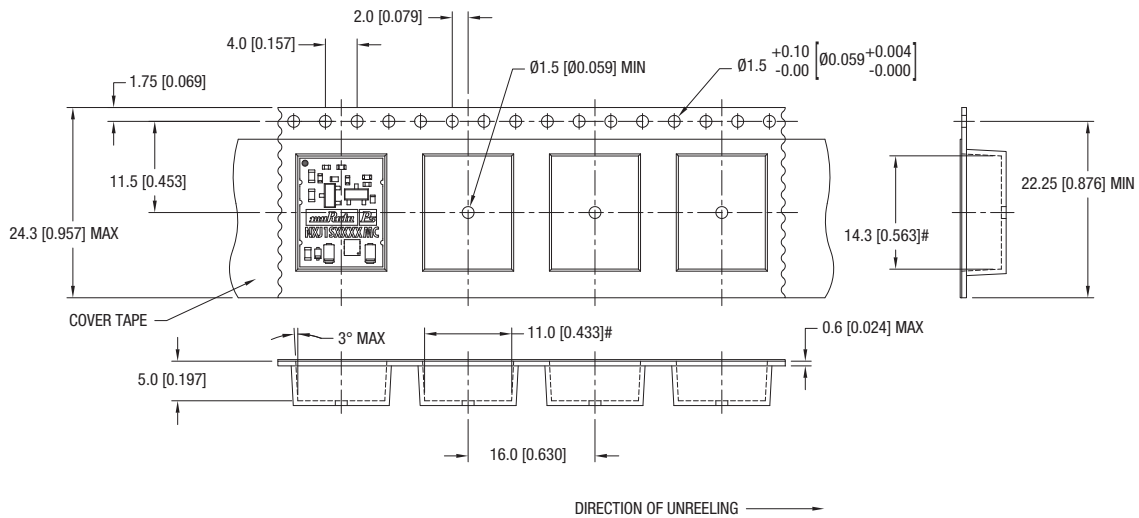

Tape & Reel specifications shall conform with current EIA-481 standard
 Unless otherwise stated all dimensions in mm (inches) $\pm 0.1\text{mm}$ (± 0.004 inches)
 Controlling dimension is mm
 Components shall be orientated within the carrier tape as indicated
 # Measured on a plane 0.3mm above the bottom pocket

DISCLAIMER

Unless otherwise stated in the datasheet, all products are designed for standard commercial and industrial applications and NOT for safety-critical and/or life-critical applications.

Particularly for safety-critical and/or life-critical applications, i.e. applications that may directly endanger or cause the loss of life, inflict bodily harm and/or loss or severe damage to equipment/property, and severely harm the environment, a prior explicit written approval from Murata is strictly required. Any use of Murata standard products for any safety-critical, life-critical or any related applications without any prior explicit written approval from Murata shall be deemed unauthorised use.

These applications include but are not limited to:

- Aircraft equipment
- Aerospace equipment
- Undersea equipment
- Power plant control equipment
- Medical equipment
- Transportation equipment (automobiles, trains, ships, etc.)
- Traffic signal equipment
- Disaster prevention / crime prevention equipment
- Data Processing equipment

Murata makes no express or implied warranty, representation, or guarantee of suitability, fitness for any particular use/purpose and/or compatibility with any application or device of the buyer, nor does Murata assume any liability whatsoever arising out of unauthorised use of any Murata product for the application of the buyer. The suitability, fitness for any particular use/purpose and/or compatibility of Murata product with any application or device of the buyer remain to be the responsibility and liability of the buyer.

Buyer represents and agrees that it has all the necessary expertise to create and implement safeguards that anticipate dangerous consequences of failures, monitor failures and their consequences, lessen the likelihood of failures that might cause harm, and take appropriate remedial actions. Buyer will fully indemnify and hold Murata, its affiliated companies, and its representatives harmless against any damages arising out of unauthorised use of any Murata products in any safety-critical and/or life-critical applications.

Remark: Murata in this section refers to Murata Manufacturing Company and its affiliated companies worldwide including, but not limited to, Murata Power Solutions.



This product is subject to the following [operating requirements](https://www.murata.com/en-eu/products/power/requirements) and the [Life and Safety Critical Application Sales Policy](https://www.murata.com/en-eu/products/power/requirements):

Refer to: <https://www.murata.com/en-eu/products/power/requirements>

Murata Power Solutions (Milton Keynes) Ltd. makes no representation that the use of its products in the circuits described herein, or the use of other technical information contained herein, will not infringe upon existing or future patent rights. The descriptions contained herein do not imply the granting of licenses to make, use, or sell equipment constructed in accordance therewith. Specifications are subject to change without notice.

© 2024 Murata Power Solutions (Milton Keynes) Ltd.