





















Click here for Alphanumeric Index		Transformers			
					
	PRODUCTS UNLIMITED	PRODUCTS UNLIMITED	PRODUCTS UNLIMITED	PRODUCTS UNLIMITED	PRODUCTS UNLIMITED
Series	4000	4000	4000	4000	4000
Type	Class II UL1585 Transformer Inherently Energy Limited	Class II UL1585 Transformer Inherently Energy Limited	Class II UL1585 Transformer Inherently Energy Limited	Class II UL1585 Transformer Inherently Energy Limited	Class II UL1585 Transformer Inherently Energy Limited
VA Rating	5, 10, 20 & 30VA	10, 20 & 30VA	20 & 40VA	40 & 50VA	40 & 50VA
Terminal Options	Wire Leads	Quick Connect	Wire Leads & Screws	Wire Leads	Quick Connect
Mounting Options	Foot or Panel	Foot or Panel	Plate	Foot or Panel	Foot or Panel
Agency Approval					
Page Number	204	205	206	207	208

Transformers					
					
	PRODUCTS UNLIMITED	PRODUCTS UNLIMITED	PRODUCTS UNLIMITED	PRODUCTS UNLIMITED	PRODUCTS UNLIMITED
Series	4000	4000	4700	4700	57
Type	Class II UL1585 Transformer Non-Inherently Energy Limited Secondary Fusing Required (Opt. integral fuse or breaker)	Class II UL1585 Transformer Non-Inherently Energy Limited Secondary Fusing Required (Opt. integral fuse or breaker)	UL506 Transformer Non-Fused	UL506 Transformer Non-Fused	Transformer Relay Inherently Energy Limited 9100 or 9400 Series Relay
VA Rating	60 & 75VA	60 & 75VA	60, 100 & 150VA	60, 100 & 150VA	40VA
Terminal Options	Wire Leads	Quick Connect	Wire Leads	Quick Connect	Wire Leads and Screws (optional Quick Connects)
Mounting Options	Foot or Panel	Foot or Panel	Foot	Foot	Plate
Agency Approval					
Page Number	209	210	211	211	212

Specifications and/or agency recognitions do not necessarily apply to all models within a particular series. When multiple ratings are listed, no individual rating may be exceeded by the combination of others.

Dimensions are shown for reference purposes only.

Dimensions are in inches over (millimeters) unless otherwise specified.

Specifications and availability subject to change.

www.tycoelectronics.com
Technical support:
Refer to inside back cover.

Alphanumeric Index

Series	Type	Page
4000	5-30VA, Wire Leads, Class II	204
4000	10-30VA, QC Terminals, Class II	205
4000	20-40VA, Plate Mount, Class II	206
4000	40-50VA, Wire Leads, Class II	207
4000	40-50VA, QC Terminals, Class II	208
4000	60-75VA, Wire Leads, Class II	209
4000	60-75VA, QC Terminals, Class II	210
4700	60-150VA, Wire Leads or QC, UL 508	211
57	Transformer Relay for HVAC	212

Transformers	201-212
--------------------	---------

Transformers..... Custom Capabilities.....203

Transformers..... Questions and Answers.....202

Transformers...Questions and Answers

What is a Transformer?

A transformer is a passive electrical device which is designed to change one AC voltage to another by magnetic induction. It "steps-up" or "steps-down" voltage in order to match incoming supply voltage from the utility to the voltage required by the user's end product. Typical USA supply voltages are 120, 208, 240, 277, 480 (and 575 in Canada). Common International voltages include 110, 220, 380, and 415.

What is an Isolation Transformer?

An isolation transformer is a transformer whose primary and secondary windings are separate for the purpose of isolating the circuit from the supply source.

What is an Autotransformer?

An autotransformer has only one winding, which is shared by the primary and secondary circuits. Autotransformers do not provide isolation but offer a substantial savings when used to obtain small increments of voltage above or below the input voltage.

What is a Class II Transformer?

A Class II transformer is used to supply Class II circuits. Class II transformers have a maximum VA (Volt-Ampere) rating of less than 100 and a maximum secondary output of 30 VAC. The maximum VA generally offered is 75 and the most common secondary voltage is 24 VAC. No load secondary voltage may be as high as 29 VAC. All Class II transformers are either inherently or non-inherently limited. This means that the maximum output current of the transformer is limited, either by the intrinsic coil impedance or by a fuse or circuit breaker. These transformers are designed to meet the requirements of U.L. 1585.

Inherently Energy Limited Transformers - Class II transformers up to 50 VA are "Inherently Limited" which means that the transformer, if overloaded, will short itself out and fail safely, *not requiring a fuse*.

Non-Inherently Energy Limited Transformers - 60 thru 75 VA Class II transformers are generally *protected by a resettable circuit breaker or a fuse* within the transformer secondary. Without this overload protection, the transformer would not satisfy the safety requirements for a Class II circuit.

What is a General Purpose Transformer?

General purpose transformers include any VA rating along with primary and secondary voltage ratings up to 600 VAC. *Although internal fusing is an option, no fusing is required.* However, applicable U.L. specifications may require fusing in the end product. These transformers are designed to meet the requirements of U.L. 506.

What is Voltage Regulation?

Voltage regulation is the percent of change in the output voltage when the load is reduced from full load to no load while the input voltage remains constant.

What is the effect of a load on a control transformer?

A control transformer is designed to provide rated output voltage at full VA. As the load decreases, the output voltage will go up. Conversely, increases in load will result in lower output voltages. Typically, the smaller the VA size of the unit, the greater difference there is between no-load and full-load voltage.

Part Numbering System

This chart illustrates a breakdown of our part numbering system on a few of our most popular models. Consult factory for your specific requirements.

Typical Part No. ▶		4000	-	01	E	07	BB	999
1. Series:		4000 = Class II (UL 1585) inherently protected or internally fused.		4500 = Autotransformer.				
		4001 = Class II (UL 1585) externally fused.		4600 = 60 Hz. only				
		4100 = No UL or CSA approval.		4700 = General Purpose (UL 506).				
2. Packaging:								
		- = Bulk Pack Y = Individual Box						
3. Primary and Secondary Voltages:								
	Primary V	Secondary V		Primary V	Secondary V			
01 =	120	24	09 =	208/240	24			
02 =	240	24	13 =	208/240/480	24			
03 =	277	24	20 =	120	12			
04 =	480	24	51 =	380/415	24			
05 =	120/208/240	24	78 =	575	24			
4. VA and Series Dimension:								
	VA Rating	Series Size		VA Rating	Series Size			
A =	10	3/4" (19.05mm)	AW =	50	7/8" (22.22 mm)			
C =	20	3/4" (19.05mm)	L =	60	15/16" (23.81mm)			
M =	30	3/4" (19.05mm)	J =	75	15/16" (23.81mm)			
E =	40	7/8" (22.22 mm)	K =	100	1 1/4" (31.75mm)			
V =	40	3/4" (19.05mm)	Z =	150	1 1/4" (31.75mm)			
5. Stack Thickness and Fusing (Generally determined at factory):								
19 = 0.5" (12.7mm) thick.		07 = 0.875" (22.225mm) thick.		15 = 1.00" (25.4mm) thick.				
02 = 0.625" (15.875mm) thick.		04 = 1.00" (25.4mm) thick.		18 = 1.25" (31.75mm) thick.				
6. Mounting and Termination:								
	Mounting	Termination		Mounting	Termination			
K =	Foot Mount	Leads	AE =	Foot Mount	QCs on Top			
BC =	4" (101.6mm) foot	Screw / Leads	BB =	Foot Mount	QCs on One Side			
G =	Panel Mount	Leads	AB =	Foot Mount	QCs on Other Side			
7. Customer ID Suffix:								
000-999 = Factory assigned customer ID								

Example: 4000-01E07BB999 This part number is a Class II transformer with a 120V primary and 24V secondary. It is 40VA and inherently energy limited. This is a foot mount transformer with quick connect terminals (line & load) exiting out of the same side of the transformer cover.

Note: This is a partial listing only. Consult factory for your specific requirements. All combinations of voltage and VA may not be available.

Custom Transformer Capabilities

In addition to our industry leading standard transformer series (see the following pages), We have a proven track record of being an innovative leader in custom transformer designs. We specialize in working with our customers in the initial stages of their design process, offering ideas and suggestions which lead to a transformer product that can be manufactured with the lowest *Defective Parts Per Million (DPPM)* levels and at the highest value to the customer. The following is a list of guidelines for transformer products which compliment our Demand Flow Manufacturing system.

Leaded Transformers - Quick Connect Transformers - PC Mount Transformers - Inductors

- 5 VA through 400 VA
- Spray on rust preventative
- Butt stack and weld lamination construction
- Molded bobbin construction
- Numerous welded bracket options
- Molded cover with integral strain relief for lead or quick connect terminal

When a transformer fits the above criteria and the customer is willing to share in the design process with us, we can both benefit from *Design For Manufacturing (DFM)*, as demonstrated in the following example:

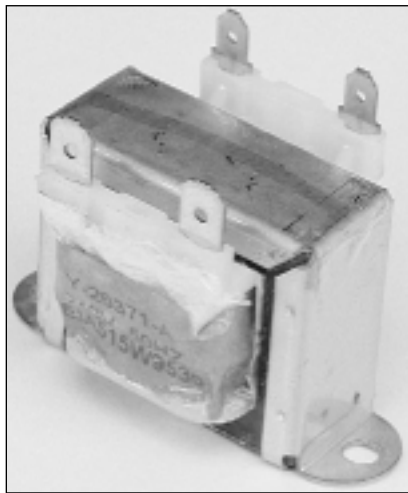

Traditional Method

- DPPM level >2000
- 10 Week lead time
- 3 Part numbers
- 12 Inventory turns
- Costly
- Fragile design

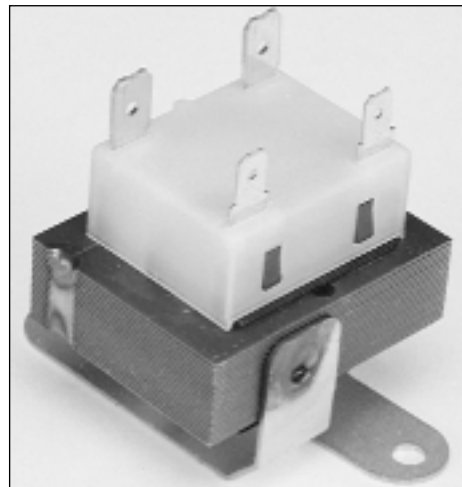

DFM Method

- DPPM level <100
- 1 Week lead time
- 1 Universal part number
- 50 Inventory turns
- 20% Cost improvement
- Robust design

Our electrical and mechanical design groups are ready to work with you on your specific product needs.



4000 series

Class II UL 1585 Transformer 5 VA - 30VA Inherently Energy Limited No Secondary Fusing Required Wire Leads

cULus File E87824

Users should thoroughly review the technical data before selecting a product part number. It is recommended that users also seek out the pertinent approvals files of the agencies/laboratories and review them to ensure the product meets the requirements for a given application.

Features

- Type K Foot Mount - features a steel bracket welded to the bottom of the laminations for easy mounting.
- Type G Panel Mount - features .179" (4.55 mm) diameter holes in each corner to allow direct mounting to a panel.
- Multiple voltage combinations are available. Consult factory for availability.

Standard "999" Models Available

Primary V	Secondary V	20VA
120	24	4000-01C02K999
120	24	4000-01C02K999

For more details about standard models see Part Numbering System table at beginning of transformer section in this catalog .

Partial Listing of Custom Models

Primary V	Secondary V	5VA	10VA	20VA	30VA
120	24	4000-01X19K*	4000-01A19K*	4000-01C02K*	4000-01M04K*
240	24	4000-02X19K*	4000-02A19K*	4000-02C02K*	4000-02M04K*
277	24	4000-03X19K*	4000-03A19K*	4000-03C02K*	4000-03M04K*
480	24	4000-04X19K*	4000-04A19K*	4000-04C02K*	4000-04M04K*
208/240	24	-	-	4000-09C02K*	4000-09M04K*
120	12	-	-	4000-20C02K*	-

* A three digit customer ID suffix will be assigned by the factory. All custom model part numbers are listed as Type K Foot Mount. To specify Type G Panel Mount, replace K in above part numbers with G.

Outline Dimensions

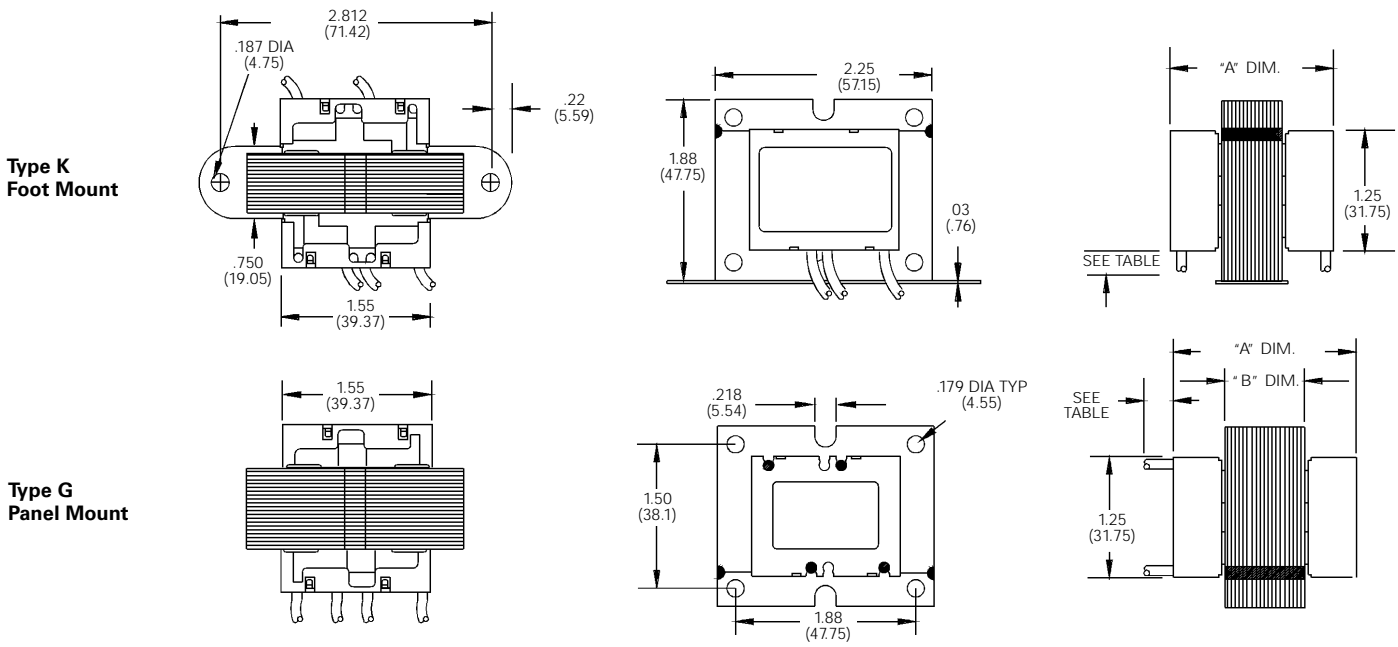

"A" and "B" Dimensions

	5 VA	10 VA	20 VA	30 VA
*A" Dimension [inches (mm)]	1.5 (38.1)	1.5 (38.1)	1.625 (41.28)	2.00 (50.8)
*B" Dimension [inches (mm)]	0.5 (12.7)	0.5 (12.7)	0.625 (15.9)	1.00 (25.4)

Details regarding leads on standard models

	Primary Leads								Secondary Leads	
	COM	120	208	240	277	480	575	24	VAC	
Voltage	Black	White	Red	Orange	Brown	Black/Red	Gray	Blue	Yellow	
Color	12 (305)	12 (305)	12 (305)	12 (305)	12 (305)	12 (305)	12 (305)	12 (305)	12 (305)	
Length [inches (mm)]	0.5 (12.7)	0.5 (12.7)	0.5 (12.7)	0.5 (12.7)	0.5 (12.7)	0.5 (12.7)	0.5 (12.7)	0.5 (12.7)	0.5 (12.7)	
Strip Length [inches (mm)]										

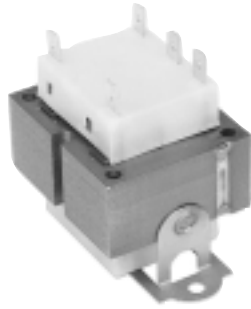

4000 series

Class II UL 1585 Transformer 10VA - 30VA Inherently Energy Limited No Secondary Fusing Required Quick Connect Terminals

UL File E87824

Users should thoroughly review the technical data before selecting a product part number. It is recommended that users also seek out the pertinent approvals files of the agencies/laboratories and review them to ensure the product meets the requirements for a given application.

Features

- Type BB Same Side Termination - features quick connect terminals with line and load terminations on the same side of transformer.
- Type AE Laydown Termination - features quick connect terminals with line and load terminations on the top of transformer.
- Type AB Opposite Side Termination - features quick connect terminals with line and load terminations on opposite sides of transformer.
- Multiple voltage combinations are available. Consult factory for availability.

Specifications

Terminals: Standard male quick connects are .250" x .032" (6.35 x .81 mm). Other available quick connects include .187" x .032" (4.75 x .81 mm) and .187" x .020" (4.75 x .51 mm).

Frequency: 50/60 Hz.

Insulation Class: UL Class B (130°C).

Weight: 10VA - 10.9 oz. (308 g); 20VA - 14.1 oz. (399 g); 30VA - 18.6 oz. (525 g).

Standard "999" Models Available

No standard models are offered.

For more details about standard models see Part Numbering System table at beginning of transformer section in this catalog .

Partial Listing of Custom Models

Primary V	Secondary V	10VA	20VA	30VA	30VA
120	24	4000-01A19BB*	4000-01C02BB*	4000-01M04BB*	4000-01M04BB*
240	24	4000-02A19BB*	4000-02C02BB*	4000-02M04BB*	4000-02M04BB*
277	24	-	-	4000-03M04BB*	4000-03M04BB*
480	24	-	-	4000-04M04BB*	4000-04M04BB*
208/240	24	-	-	4000-09M04BB*	4000-09M04BB*
120	12	-	4000-20C02BB*	-	-

* A three digit customer ID suffix will be assigned by the factory.
To specify Type AE Laydown Termination, replace BB in above part numbers with AE.

Outline Dimensions

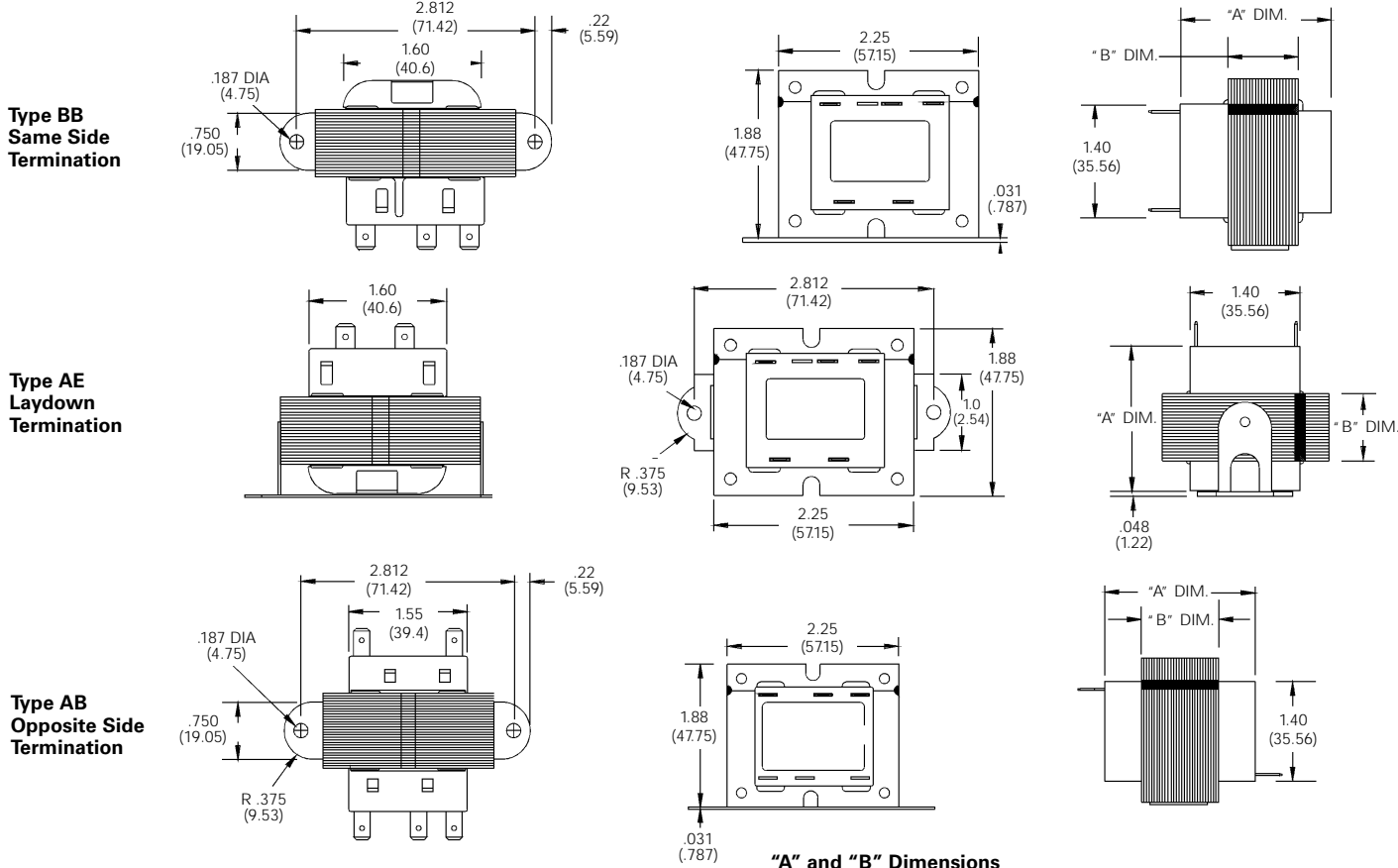

	10VA	20VA	30VA
"A" Dimension [inches (mm)]	1.50 (38.1)	1.625 (41.28)	2.00 (50.8)
"B" Dimension [inches (mm)]	.50 (12.7)	0.625 (15.88)	1.00 (25.4)

Dimensions are shown for reference purposes only.

Dimensions are in inches or (millimeters) unless otherwise specified.

Specifications and availability subject to change.

www.tycoelectronics.com
Technical support:
Refer to inside back cover.



4000 series

Class II UL 1585 Transformer 20VA - 40VA Inherently Energy Limited No Secondary Fusing Required Plate for Electrical Box Mounting

UL File E87824

Users should thoroughly review the technical data before selecting a product part number. It is recommended that users also seek out the pertinent approvals files of the agencies/laboratories and review them to ensure the product meets the requirements for a given application.

Features

- Type BC Plate Mount - mounted on a 4" (101.6mm) square plate designed to fit a standard 4" (101.6mm) square electrical box.
- The line voltage is connected inside the electrical box to the color-coded leads on the transformer. The low voltage is terminated to either 1/4" (4.75 mm) quick connects and/or #6-32 screw furnished on the secondary side.
- Multiple voltage combinations are available. Consult factory for availability.

Standard "999" Models Available

Primary V	Secondary V	20VA	40VA
120	24	4000-01C02BC999	4000-01V18BC999

For more details about standard models see Part Numbering System table at beginning of transformer section in this catalog .

Specifications

- Wire Size:** All leads are 18 AWG stranded 2/64" (.794 mm) insulation thickness. Standard parts have 12" (305 mm) total length with 1/2" (12.7 mm) strip.
- Frequency:** 50/60 Hz.
- Insulation Class:** UL Class B (130°C).
- Weight:** 20VA - 19.2 oz. (544 g); 40VA - 32 oz. (906 g).

Partial Listing of Custom Models

Primary V	Secondary V	20VA	40VA
120	24	4000-01C02BC*	4000-01V18BC*
208/240	24	4000-09C02BC*	4000-09V18BC*

* A three digit customer ID suffix will be assigned by the factory. All custom model part numbers are listed as Type K Foot Mount. To specify Type G Panel Mount, replace K in above part numbers with G.

Outline Dimensions

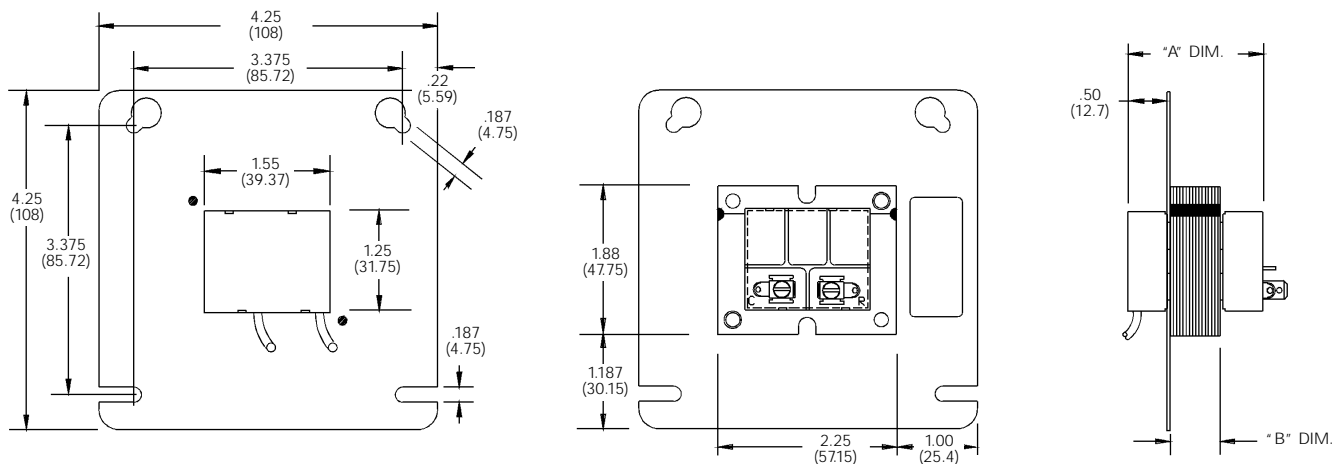

"A" and "B" Dimensions

	20 VA	40 VA
"A" Dimension [inches (mm)]	1.625 (41.28)	2.56 (65.02)
"B" Dimension [inches (mm)]	.625 (15.88)	1.25 (31.75)

Details regarding leads on standard models

Voltage	Primary Leads							Secondary Leads	
	COM	120	208	240	277	480	575	24	VAC
Color	Black	White	Red	Orange	Brown	Black/Red	Gray	Blue	Yellow
Length [inches (mm)]	12 (305)	12 (305)	12 (305)	12 (305)	12 (305)	12 (305)	12 (305)	12 (305)	12 (305)
Strip Length [inches (mm)]	0.5 (12.7)	0.5 (12.7)	0.5 (12.7)	0.5 (12.7)	0.5 (12.7)	0.5 (12.7)	0.5 (12.7)	0.5 (12.7)	0.5 (12.7)



4000 series

Class II UL 1585 Transformer 40 VA - 50VA Inherently Energy Limited No Secondary Fusing Required Wire Leads

us File E87824

Users should thoroughly review the technical data before selecting a product part number. It is recommended that users also seek out the pertinent approvals files of the agencies/laboratories and review them to ensure the product meets the requirements for a given application.

Features

- Type K Foot Mount - features a steel bracket welded to the bottom of the laminations for easy mounting.
- Type G Panel Mount - features .156" (3.96 mm) diameter holes in each corner to allow direct mounting to a panel.
- Multiple voltage combinations are available. Consult factory for availability.

Specifications

Wire Size: All leads are 18 AWG stranded 2/64" (.794 mm) insulation thickness. Standard parts have 12" (305 mm) total length with 1/2" (12.7 mm) strip.

Frequency: 50/60 Hz.

Insulation Class: UL Class B (130°C).

Weight: 40VA - 24.3 oz. (600 g); 50VA - 33.6 oz. (953 g).

Standard "999" Models Available

Primary V	Secondary V	40VA	50VA
120	24	4000-01E07K999	4000-01AW18K999
277	24	4000-03E07K999	4000-03AW18K999
480	24	4000-04E07K999	4000-04AW18K999
120/208/240	24	4000-05E07K999	-
208/240	24	4000-09E07K999	4000-09AW18K999

For more details about standard models see Part Numbering System table at beginning of transformer section in this catalog .

Partial Listing of Custom Models

Primary V	Secondary V	40VA	40VA	50VA
120	24	4000-01V18K*	4000-01E07K*	4000-01AW18K*
240	24	4000-02V18K*	4000-02E07K*	4000-02AW18K*
277	24	4000-03V18K*	4000-03E07K*	4000-03AW18K*
480	24	4000-04V18K*	4000-04E07K*	4000-04AW18K*
120/208/240	24	-	4000-05E07K*	-
208/240	24	4000-09V18K*	4000-09E07K*	4000-09AW18K*
208/240/480	24	-	4000-13E07K*	-
380/415	24	4000-51V18K*	4000-51E07K*	4000-51AW18K*
575	24	4000-78V18K*	4000-78E07K*	4000-78AW18K*

* A three digit customer ID suffix will be assigned by the factory.
All custom model part numbers are listed as Type K Foot Mount. To specify Type G Panel Mount, replace K in above part numbers with G.

Outline Dimensions

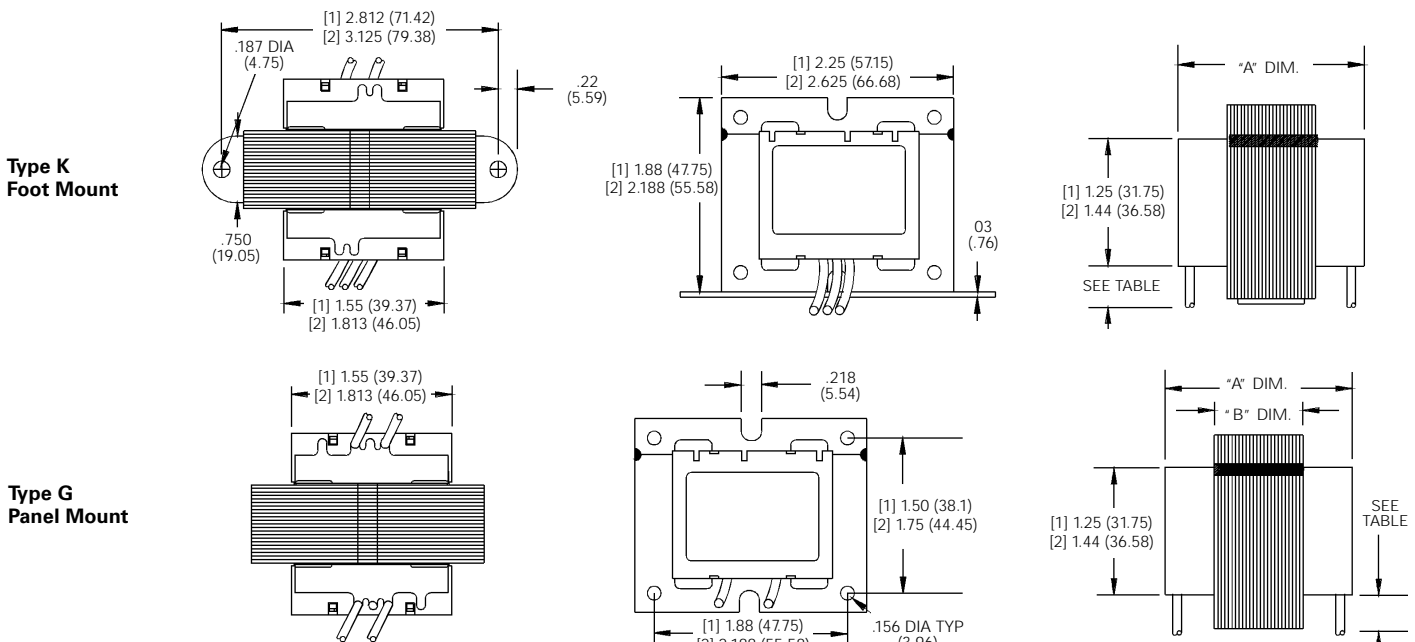

[1] Applies to V18 models.
[2] Applies to E07 & AW18 models.

	40 VA / V18	40 VA / E07	50 VA / AW18
"A" Dimension [inches (mm)]	2.25 (57.15)	2.125 (53.98)	2.56 (65.02)
"B" Dimension [inches (mm)]	1.25 (31.75)	0.875 (22.22)	1.25 (31.75)

Details regarding leads on standard models

Voltage	Primary Leads							Secondary Leads	
	COM	120	208	240	277	480	575	24	VAC
Color	Black	White	Red	Orange	Brown	Black/Red	Gray	Blue	Yellow
Length [inches (mm)]	12 (305)	12 (305)	12 (305)	12 (305)	12 (305)	12 (305)	12 (305)	12 (305)	12 (305)
Strip Length [inches (mm)]	0.5 (12.7)	0.5 (12.7)	0.5 (12.7)	0.5 (12.7)	0.5 (12.7)	0.5 (12.7)	0.5 (12.7)	0.5 (12.7)	0.5 (12.7)

Dimensions are shown for reference purposes only.

Dimensions are in inches or (millimeters) unless otherwise specified.

Specifications and availability subject to change.

www.tycoelectronics.com
Technical support:
Refer to inside back cover.

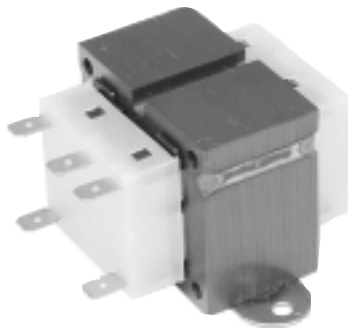

4000 series

Class II UL 1585 Transformer
40VA - 50VA Inherently Energy Limited
No Secondary Fusing Required
Quick Connect Terminals

UL File E87824

Users should thoroughly review the technical data before selecting a product part number. It is recommended that users also seek out the pertinent approvals files of the agencies/laboratories and review them to ensure the product meets the requirements for a given application.

Features

- Type BB Same Side Termination - features quick connect terminals with line and load terminations on the same side of transformer.
- Type AE Laydown Termination - features quick connect terminals with line and load terminations on the top of transformer.
- Type AB Opposite Side Termination - features quick connect terminals with line and load terminations on opposite sides of transformer.
- Multiple voltage combinations are available. Consult factory for availability.

Standard "999" Models Available

Primary V	Secondary V	40VA
120	24	4000-01E07AE999
120	24	4000-01E07BB999
208/240	24	4000-09E07AE999

For more details about standard models see Part Numbering System table at beginning of transformer section in this catalog .

Partial Listing of Custom Models

Primary V	Secondary V	40VA	40VA	40VA	50VA
120	24	4000-01E07BB*	4000-01V18BB*	4000-01V18AB*	4000-01AW18BB*
240	24	4000-02E07BB*	4000-02V18BB*	4000-02V18AB*	4000-02AW18BB*
277	24	4000-03E07BB*	4000-03V18BB*	4000-03V18AB*	4000-03AW18BB*
480	24	4000-04E07BB*	4000-04V18BB*	4000-04V18AB*	4000-04AW18BB*
208/240	24	4000-09E07BB*	4000-09V18BB*	4000-09V18AB*	4000-09AW18BB*
380/415	24	4000-51E07BB*	4000-51V18BB*	4000-51V18AB*	4000-51AW18BB*
575	24	4000-78E07BB*	4000-78V18BB*	-	4000-78AW18BB*

* A three digit customer ID suffix will be assigned by the factory.
To specify Type AE Laydown Termination, replace BB in above part numbers with AE.

Outline Dimensions

Type BB Same Side Termination

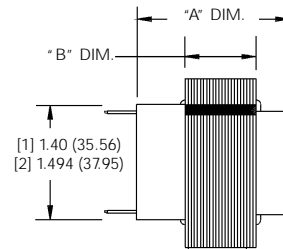
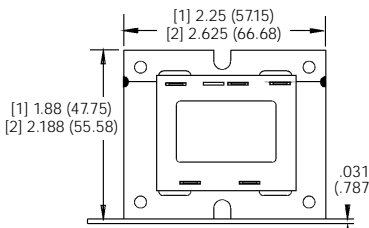
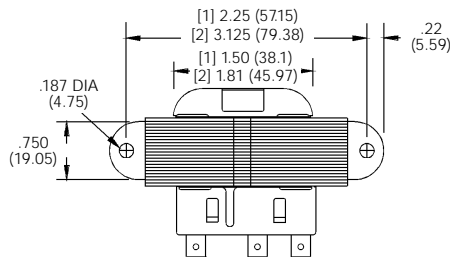

Type AE Laydown Termination

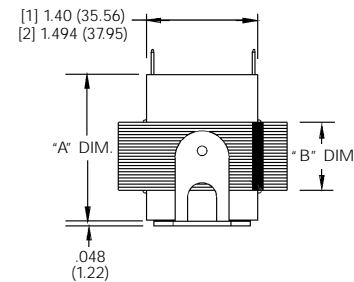
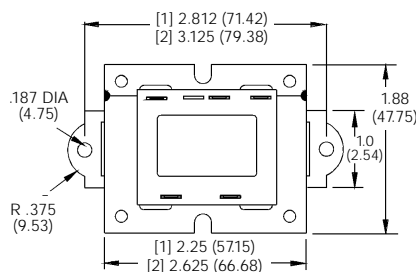
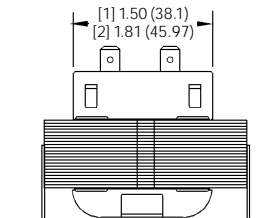

Type AB Opposite Side Termination

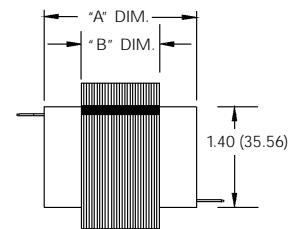
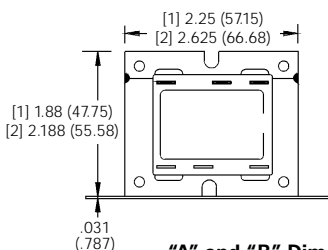
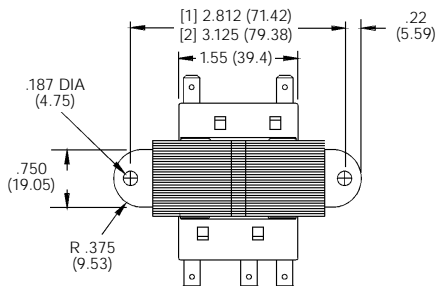

[1] Applies to V18 models.
[2] Applies to E07 & AW18 models.

"A" and "B" Dimensions

	40 VA / V18	40 VA / E07	50 VA / AW18
"A" Dimension [inches (mm)]	2.25 (57.15)	2.125 (53.98)	2.56 (65.02)
"B" Dimension [inches (mm)]	1.25 (31.75)	0.875 (22.22)	1.25 (31.75)



4000 series

Class II UL 1585 Transformer 60VA -75VA Non-Inherently Energy Limited Secondary Fusing Required Wire Leads

File E87824

Users should thoroughly review the technical data before selecting a product part number. It is recommended that users also seek out the pertinent approvals files of the agencies/laboratories and review them to ensure the product meets the requirements for a given application.

Features

- Type K Foot Mount - features a steel bracket welded to the bottom of the laminations for easy mounting.
- Type G Panel Mount - features .218" (5.54 mm) diameter holes in each corner to allow direct mounting to a panel.
- For agency approval, 60 & 75VA transformers must have one of the following overcurrent protectors in series with the secondary winding: Internal fuse, integral circuit breaker. Any customer-supplied fusing or protection must be approved by the factory.
- Multiple voltage combinations are available. Consult factory for availability.

Standard "999" Models Available

Primary V	Secondary V	75VA
120	24	4000-01J15K999
277	24	4000-03J15K999
208/240	24	4000-09J15K999
575	24	4000-78J15K999
120/208/240/480	24	4000-08J15K999

For more details about standard models see Part Numbering System table at beginning of transformer section in this catalog . All 75VA standard models come with an integral circuit breaker.

Specifications

Wire Size: All leads are 18 AWG stranded 2/64" (.794 mm) insulation thickness. Standard parts have 12" (305 mm) total length with 1/2" (12.7 mm) strip.

Frequency: 50/60 Hz.

Insulation Class: UL Class B (130°C).

Weight: 60VA – 35.2 oz. (997 g); 75VA – 38.4 oz. (1087 g).

Partial Listing of Custom Models

Primary V	Secondary V	60VA	75VA
120	24	4000-01L15K*	4000-01J15K*
240	24	4000-02L15K*	4000-02J15K*
277	24	4000-03L15K*	4000-03J15K*
480	24	4000-04L15K*	4000-04J15K*
120/208/240	24	4000-05L15K*	4000-05J15K*
208/240	24	4000-09L15K*	4000-09J15K*
208/240/480	24	-	4000-13J15K*
380/415	24	-	4000-51J15K*
575	24	-	4000-78J15K*

* A three digit customer ID suffix will be assigned by the factory. For Type G Panel Mount, replace K in above part numbers with G.

Outline Dimensions

**Type K
Foot Mount -
Internally
Fused**

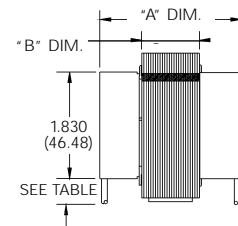
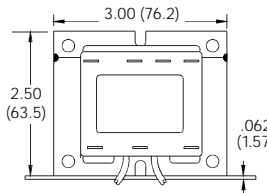
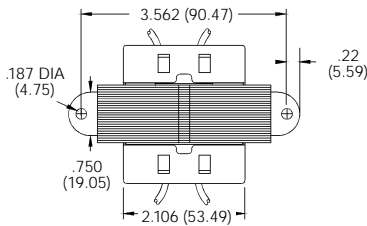

**Type K
Foot Mount -
Integral
Circuit
Breaker**

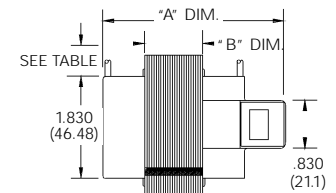
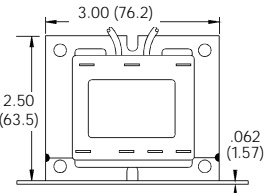
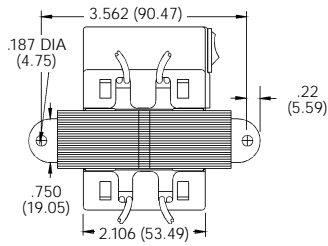

**Type G
Panel Mount**

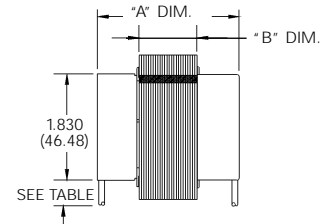
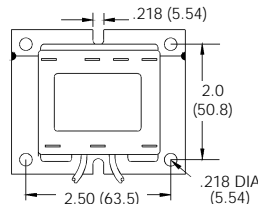
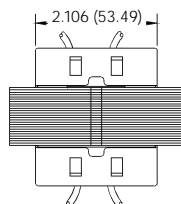

"A" and "B" Dimensions for 60VA & 75VA Models

	L15K & J15K Internally Fused	L15K & J15K w/ Integral Circuit Breaker	J41K Standard Part
"A" Dimension [inches (mm)]	2.475 (62.86)	3.25 (82.55)	3.45 (87.63)
"B" Dimension [inches (mm)]	1.00 (25.4)	1.00 (25.4)	1.125 (28.58)

Details regarding leads on standard models

Voltage	Primary Leads							Secondary Leads	
	COM	120	208	240	277	480	575	24	VAC
Color	Black	White	Red	Orange	Brown	Black/Red	Gray	Blue	Yellow
Length [inches (mm)]	12 (305)	12 (305)	12 (305)	12 (305)	12 (305)	12 (305)	12 (305)	12 (305)	12 (305)
Strip Length [inches (mm)]	0.5 (12.7)	0.5 (12.7)	0.5 (12.7)	0.5 (12.7)	0.5 (12.7)	0.5 (12.7)	0.5 (12.7)	0.5 (12.7)	0.5 (12.7)

Dimensions are shown for reference purposes only.

Dimensions are in inches or (millimeters) unless otherwise specified.

Specifications and availability subject to change.

www.tycoelectronics.com
Technical support:
Refer to inside back cover.

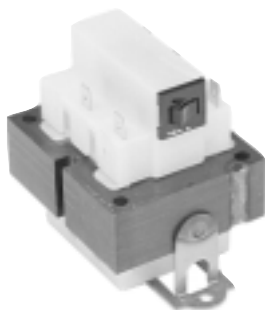

4000 series

Class II UL 1585 Transformer 60VA -75VA Non-Inherently Energy Limited Secondary Fusing Required Quick Connect Terminals

UL File E87824

Users should thoroughly review the technical data before selecting a product part number. It is recommended that users also seek out the pertinent approvals files of the agencies/laboratories and review them to ensure the product meets the requirements for a given application.

Features

- Type BB Same Side Termination - features quick connect terminals with line and load terminations on the same side of transformer.
- Type AE Laydown Termination - features quick connect terminals with line and load terminations on the top of transformer.
- For agency approval, 60 & 75VA transformers must have one of the following overcurrent protectors in series with the secondary winding: Internal fuse, integral circuit breaker. Any customer-supplied fusing or protection must be approved by the factory.
- Multiple voltage combinations are available. Consult factory for availability.

Standard "999" Models Available

Primary V	Secondary V	75VA
120	24	4000-01J15AE999
208/240	24	4000-09J15AE999

For more details about standard models see Part Numbering System table at beginning of transformer section in this catalog. All 75VA standard models come with an integral circuit breaker.

Specifications

Terminals: Standard male quick connects are .250" x .032" (6.35 x .81 mm). Other available quick connects include .187" x .032" (4.75 x .81 mm) and .187" x .020" (4.75 x .51 mm).

Frequency: 50/60 Hz.

Insulation Class: UL Class B (130°C).

Weight: 60VA – 35.2 oz. (997 g); 75VA – 38.4 oz. (1087 g).

Partial Listing of Custom Models

Primary V	Secondary V	60VA	75VA
120	24	4000-01L15BB*	4000-01J15BB*
240	24	4000-02L15BB*	4000-02J15BB*
277	24	4000-03L15BB*	4000-03J15BB*
480	24	4000-04L15BB*	4000-04J15BB*
120/208/240	24	4000-05L15BB*	4000-05J15BB*
208/240	24	4000-09L15BB*	4000-09J15BB*
208/240/480	24	-	4000-13J15BB*
380/415	24	-	4000-51J15BB*
575	24	-	4000-78J15BB*

* A three digit customer ID suffix will be assigned by the factory. For Type AE Laydown Termination, replace BB in above part numbers with AE.

Outline Dimensions

**Type BB
Same Side
Termination**

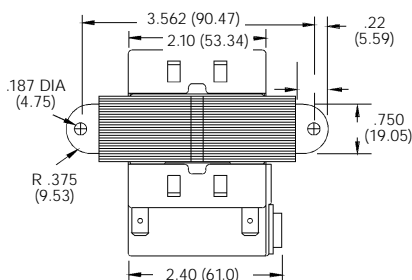

**Type AE
Laydown
Termination -
Internally Fused**

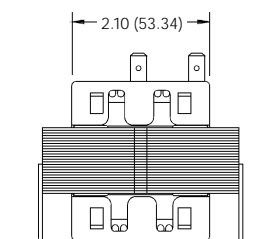

**Type AE
Laydown
Termination -
Integral
Circuit
Breaker**

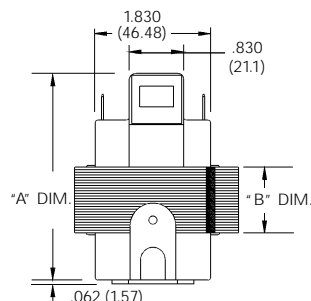
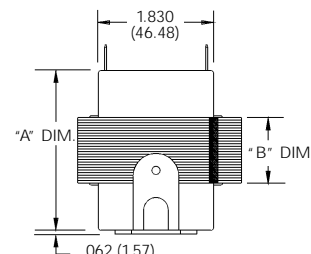
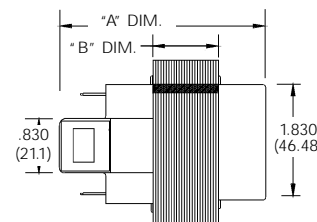
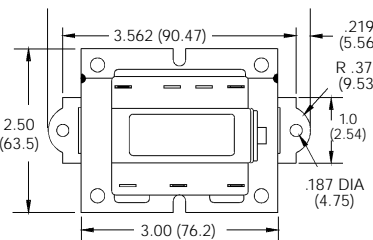
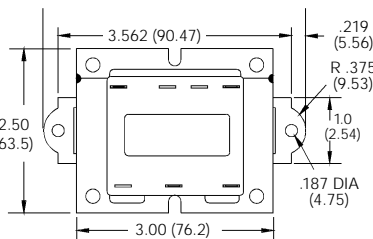
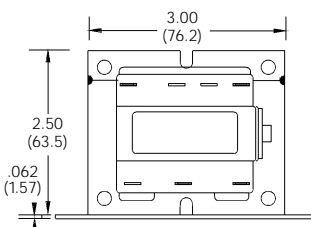
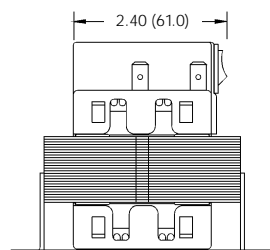

"A" and "B" Dimensions for 60VA & 75VA Models

	Internally Fused	w/ Integral Circuit Breaker
"A" Dimension [inches (mm)]	2.475 (62.86)	3.25 (82.55)
"B" Dimension [inches (mm)]	1.00 (25.4)	1.00 (25.4)



4700 series

UL 506 Transformer 60VA - 150VA Non-Fused Wire Leads or Quick Connects

UL File E102980

Users should thoroughly review the technical data before selecting a product part number. It is recommended that users also seek out the pertinent approvals files of the agencies/laboratories and review them to ensure the product meets the requirements for a given application.

Features

- Type K Foot Mount - features wire leads and a steel bracket welded to the bottom of the laminations for easy mounting.
- Type BB Same Side Termination - features quick connect terminals with line and load terminations on the same side of transformer.
- Multiple voltage combinations are available. Consult factory for availability.

Specifications

- Wire Size:** All leads are 18 AWG stranded 2/64" (.794 mm) insulation thickness. Standard parts have 12" (305 mm) total length with 1/2" (12.7 mm) strip.
- Terminals:** Standard male quick connects are .250" x .032" (6.35 x .81 mm). Other available quick connects include .187" x .032" (4.75 x .81 mm) and .187" x .020" (4.75 x .51 mm).
- Frequency:** 50/60 Hz.
- Insulation Class:** UL Class B (130°C).
- Weight:** 60VA – 36.8 oz. (1042 g); 100VA – 80 oz. (2270 g); 150VA – 83.2 oz. (2356 g).

Standard "999" Models Available

Primary V	Secondary V	60VA	100VA
120	24	4700-81L15K999	-
120/208/240/480	24	-	4700-08K18K999

For more details about standard models see Part Numbering System table at beginning of transformer section in this catalog .

Partial Listing of Custom Models

Primary V	Secondary V	100VA	150VA
120	24	4700-01K18K*	4700-01Z18K*
277	24	4700-03K18K*	4700-03Z18K*
480	24	4700-04K18K*	4700-04Z18K*
120/208/240/480	24	4700-08K18K*	-
208/240	24	4700-09K18K*	4700-09Z18K*
208/230/460	24	4700-12K18K*	-
208/240/480	24	4700-13K18K*	-
400	24	4700-48K18K*	4700-48Z18K*
575	24	4700-78K18K*	4700-78Z18K*
460/575	24	4700-130K18K*	4700-130Z18K*

* A three digit customer ID suffix will be assigned by the factory.

Outline Dimensions

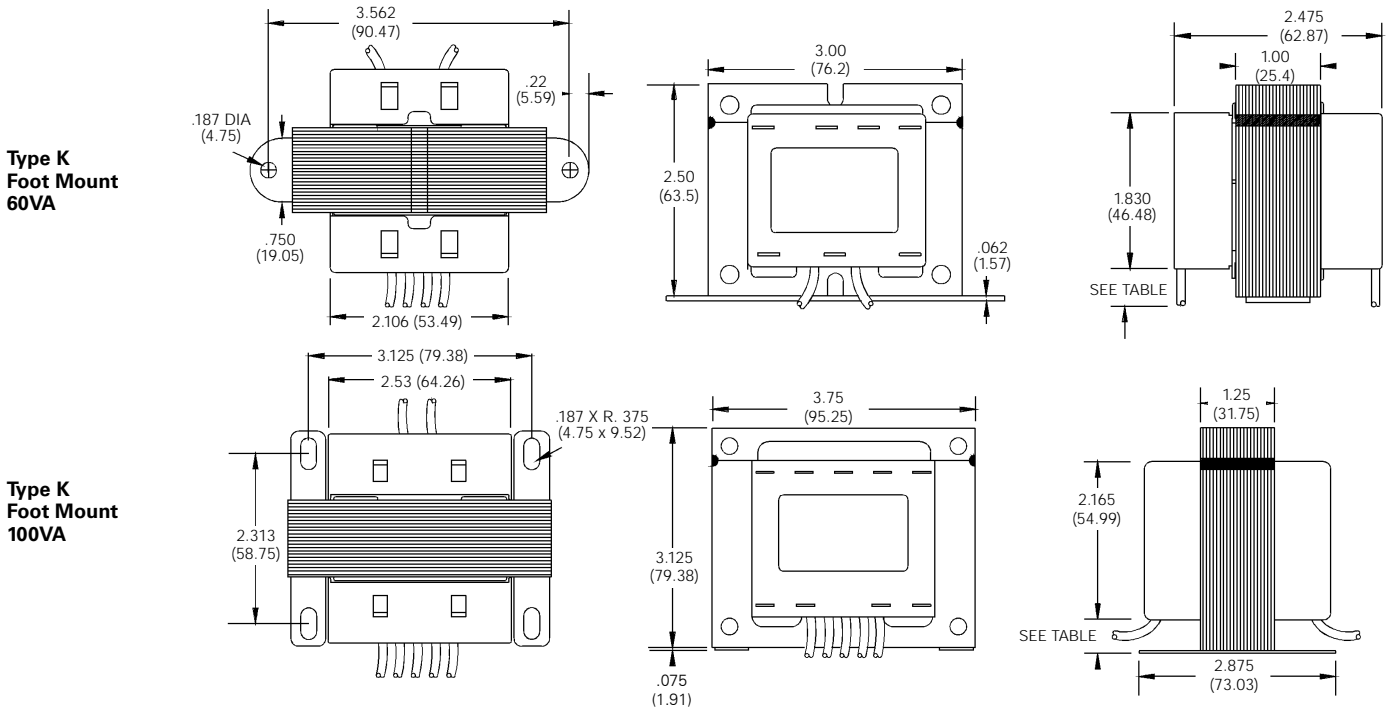

Voltage	Primary Leads							Secondary Leads	
	COM	120	208	240	277	480	575	24	VAC
Color	Black	White	Red	Orange	Brown	Black/Red	Gray	Blue	Yellow
Length [inches (mm)]	12 (305)	12 (305)	12 (305)	12 (305)	12 (305)	12 (305)	12 (305)	12 (305)	12 (305)
Strip Length [inches (mm)]	0.5 (12.7)	0.5 (12.7)	0.5 (12.7)	0.5 (12.7)	0.5 (12.7)	0.5 (12.7)	0.5 (12.7)	0.5 (12.7)	0.5 (12.7)

Dimensions are shown for reference purposes only.

Dimensions are in inches or (millimeters) unless otherwise specified.

Specifications and availability subject to change.

www.tycoelectronics.com
Technical support:
Refer to inside back cover.

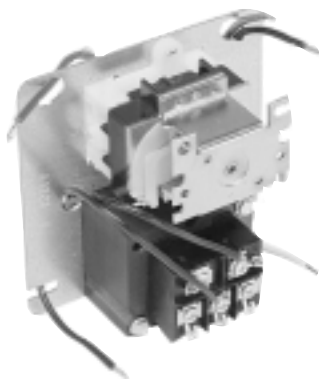

57 series

Transformer Relay for HVAC Applications

UL File E113772

Users should thoroughly review the technical data before selecting a product part number. It is recommended that users also seek out the pertinent approvals files of the agencies/laboratories and review them to ensure the product meets the requirements for a given application.

Features

- Cover mounts on conventional 4" square box.
- All leads terminate in the box.
- Leads are 8" (203.2 mm) long with 1/2" (12.7mm) stripped
- Standard transformer is 40VA Class II Energy Limited. Other transformers are available.
- Five secondary terminations (two are hot) for thermostat connection and #6-32 screw termination is standard. Quick connects are optional.
- Assembled with choice of 9100 or 9400 series relays.
- Custom-built to meet customer requirements.

Relay Data @ 25°C

Arrangements: 1 Form A (SPST-NO) through 2 Form C (DPDT), depending upon relay selected

Rating: 9100 Series Relay: 12 FLA, 60 LRA, 15A resistive @ 125VAC;
6 FLA, 36 LRA, 15A resistive @ 240VAC;
3/4 HP @ 125/250VAC.

9400 Series Relay: 12 FLA, 60 LRA, 18A resistive @ 125VAC;
8 FLA, 48 LRA, 18A resistive @ 240VAC.

Specifications

Insulation Class: UL Class B (130°C).

Duty Cycle: Continuous.

Weight: 32 oz. (909 g) approximately

Ordering Information

57 series products are custom-built. Your Tyco Electronics sales engineer will need to consult with the factory to develop a model meeting your needs.

Standard part numbers listed below are more likely to be available from stock.

Custom parts only.

Outline Dimensions

Using
9100
Series
Relay

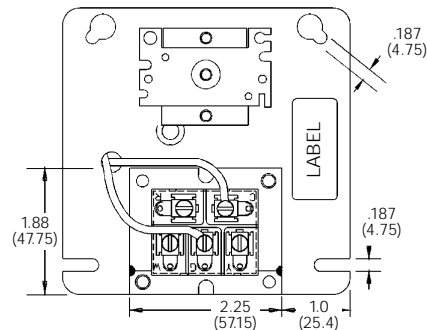
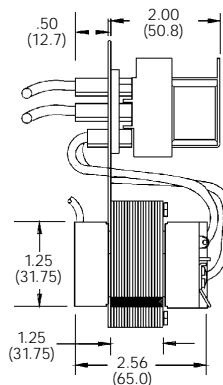
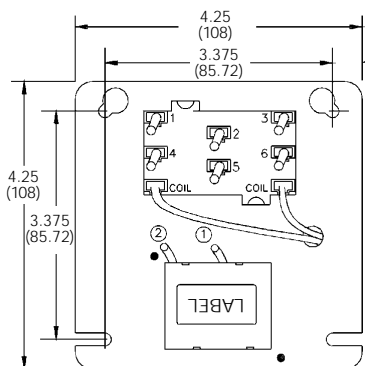

Using
9400
Series
Relay

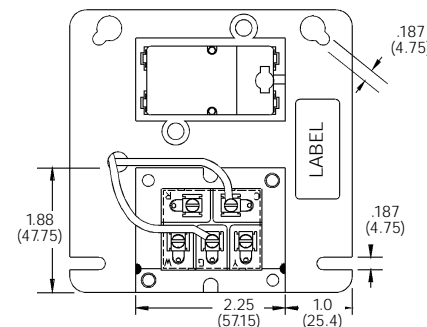
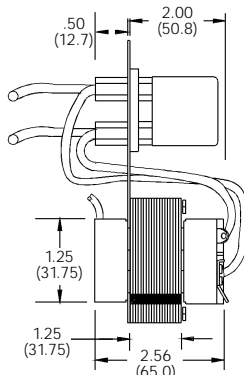
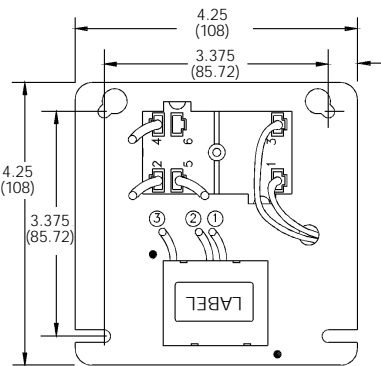

Mouser Electronics

Authorized Distributor

Click to View Pricing, Inventory, Delivery & Lifecycle Information:

TE Connectivity:

[4000A01E07AE999](#) [4000B01E07AE999](#) [4000A09M04K22](#) [4000-20M04K999](#) [4700Y96J34K777](#) [4001-20CN15K777](#)
[4700-01Z18BB999](#) [4000Y05E07K777](#) [48RO-5000G-SIL](#) [4600-01V04K369](#) [4600-01AZ13K999](#) [4700R09K18K999](#)
[4000Y09AW18K777](#) [4611-A-1001](#) [47045010](#) [4600-01AZ13AE999](#) [4001-09W15AE777](#) [4000Y09L15K777](#)
[4000Y02AW18K777](#)