

Delivering leading edge, innovative power solutions for more than 30 years....

Model:GTM962250PWWWVX-XF

November 7, 2024

GTM962250PWWWVX-XF

Information

Model Number

GTM962250PWWWVX-XF

Description

GTM962250PWWWVX-XF, ICT / ITE / Medical Power Supply, 60601-1-4th Ed. , Open Frame/ L Frame/Cage/ Potted Internal, Regulated Switchmode AC-DC Power Supply AC Adaptor, Forced airflow for full rated power (CFM): 10CFM, Input Rating: 100-240V~, 50-60 Hz, , Output Rating: 225 Watts, Power rating with convection cooling (W) 140W, 12-54V in 0.1V increments, Approvals: WEEE; VCCI; Ukraine; CE; China RoHS; RoHS; Level VI; EAC; CB 60335; CB 60601-1; ETL; Conforms to 62368-1; CB 60950; cETLus 60950-1; ETL 62368; Morocco; CB 62368; UKCA; CCC; CB 61158 (pending);

Model Picture

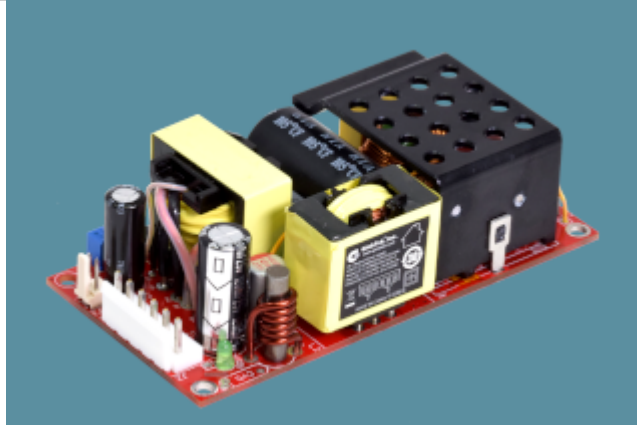

Agency Documents

<http://www.globtek.info/certs/GTM96225xP%20/>

CE EC-Declaration

https://www.globtek.com/pdf/ec_declaration/a000c000000IkX6EAJ

RoHS/RoHS2 Declaration

https://www.globtek.com/pdf/rohs_cert/a000c000000IkX6EAJ

REACH Declaration

https://www.globtek.com/pdf/iso_certificates/REACH.pdf

Conflict Minerals Declaration

<https://www.globtek.com/pdf/conflict-minerals.pdf>

Delivering leading edge, innovative power solutions for more than **30** years....

Model:GTM962250PWWWVX-XF

November 7, 2024

MODEL PARAMETERS

Type	Open Frame/ L Frame/Cage/ Potted Internal
Technology	Regulated Switchmode AC-DC Power Supply AC Adaptor
Category	ICT / ITE / Medical Power Supply
Input Voltage	100-240V~, 50-60 Hz
I/P Amps (A)	3A
Wattage (W)	225.0
Vout Range (V)	12-54
Efficiency Level	USA DOE Level VI / Eco-design Directive 2009/125/EC, (EU) 2019/1782
Ingress Protection	N/A
Size (mm)	101.6 (L) x 50.8 (W) x 31.0 (H)

PROPRIETARY INFORMATION

PROPRIETARY OF GLOBTEK, INC. ANY REPRODUCTION, DISCLOSURE OR USE OF THIS DRAWING, IN WHOLE OR IN PART, IS HEREBY PROHIBITED EXCEPT AS SPECIFIED IN WRITING BY GLOBTEK, INC.

<https://www.globtek.com/ds/BQi8tKjtmez/MXkNGNS9Ab5.html>

Delivering leading edge, innovative power solutions for more than 30 years....

Model:GTM962250PWWWVX-XF

November 7, 2024

ENCLOSURE

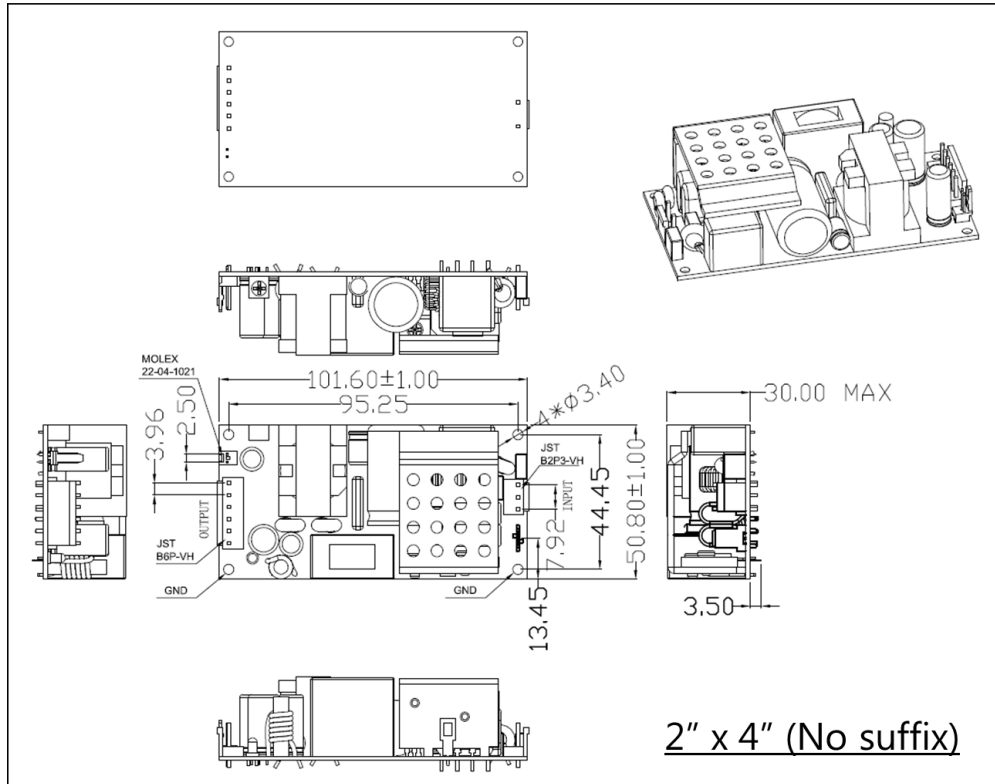

Delivering leading edge, innovative power solutions for more than **30** years....

Model:GTM962250PWWWVX-XF

November 7, 2024

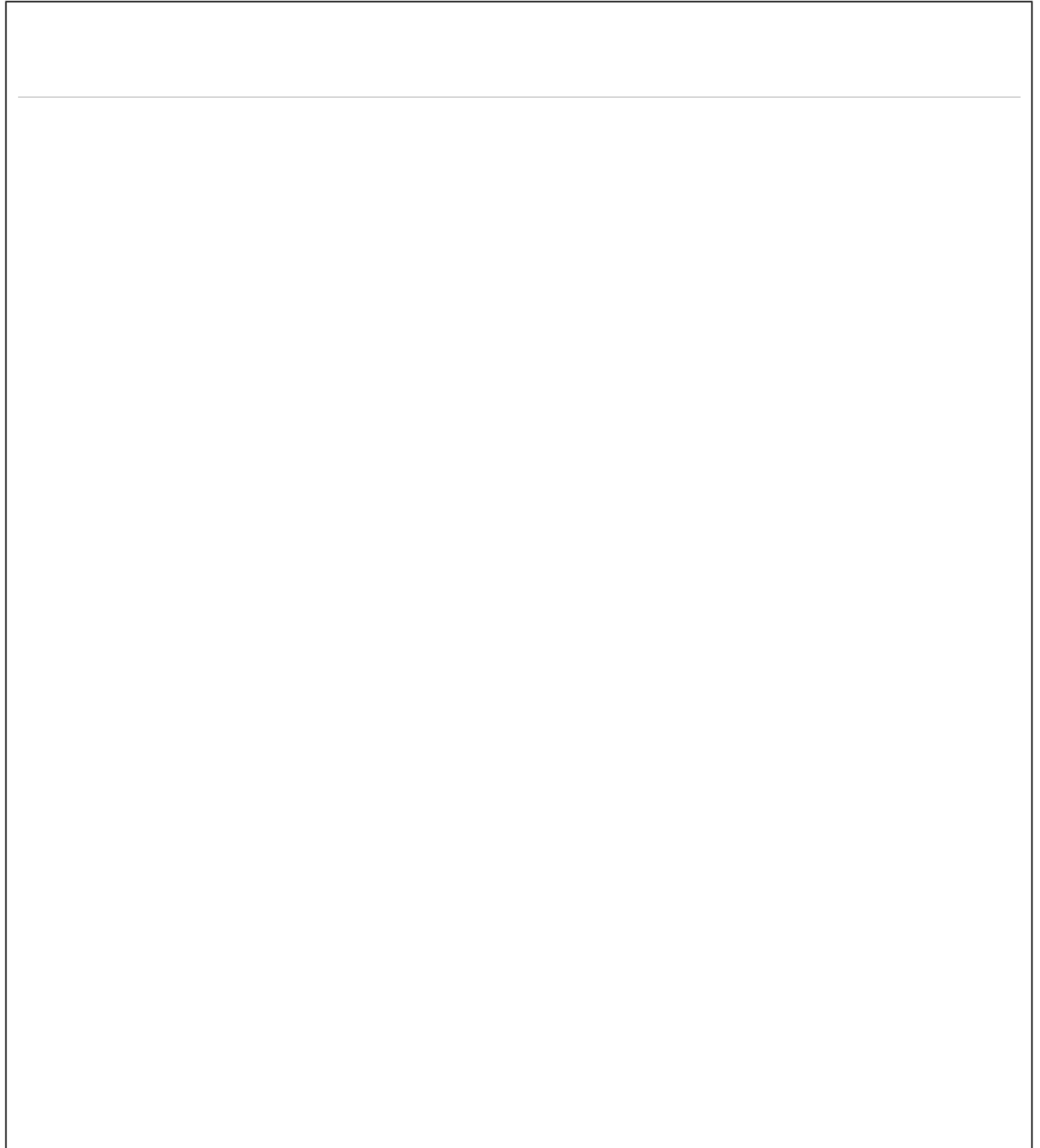

PROPRIETARY INFORMATION

PROPRIETARY OF GLOBTEK, INC. ANY REPRODUCTION, DISCLOSURE OR USE OF THIS DRAWING, IN WHOLE OR IN PART, IS HEREBY PROHIBITED EXCEPT AS SPECIFIED IN WRITING BY GLOBTEK, INC.

<https://www.globtek.com/ds/BQi8tKjtmez/MXkNGNS9Ab5.html>

Delivering leading edge, innovative power solutions for more than 30 years....

Model:GTM962250PWWWVX-XF

November 7, 2024

RATING TABLE

Model Number	Voltage	Amps(A)	Watts(W)	RFQ
GTM962250P22512A-F	12 V	18.75	225.00	RFQ
GTM962250P22512A-F_	12 V	17.55	210.60	RFQ
GTM962250P22515A-F	15 V	15	225.00	RFQ
GTM962250P22516A-F	16 V	14.06	224.96	RFQ
GTM962250P22516-F	16 V	14.06	224.96	RFQ
GTM962250P22518A-F	18 V	12.5	225.00	RFQ
GTM962250P22518-F	18 V	12.5	225.00	RFQ
GTM962250P22519A-F	19 V	11.84	224.96	RFQ
GTM962250P13024B-EF	24 V	5	120.00	RFQ
GTM962250P22524A-F	24 V	9.37	224.88	RFQ
GTM962250P22524B-EF	24 V	9.37	224.88	RFQ
GTM962250P22530AC-F	30 V	7.5	225.00	RFQ
GTM962250P22530A-F	30 V	7.5	225.00	RFQ
GTM962250P22536-F	36 V	6.25	225.00	RFQ
GTM962250P22536A-CF	36 V	6.25	225.00	RFQ
GTM962250P22536A-F	36 V	6.25	225.00	RFQ
GTM962250P22538A-F	38 V	5.92	224.96	RFQ
GTM962250P22548A-F	48 V	4.68	224.64	RFQ
GTM962250P22548A-CF	48 V	4.68	224.64	RFQ
GTM962250P22554A-F	54 V	4.16	224.64	RFQ

Delivering leading edge, innovative power solutions for more than 30 years....

Model:GTM962250PWWWVX-XF

November 7, 2024

SPECIFICATIONS

Features

- High power density 2" x 4" format (3" x 5" and 4.22" x 7" formats also available)
- 2" x 4" version available in L-frame and cage configurations
- Low conducted & radiated EMI: Class B without external filters, ferrites, or metal planes (all input configurations, into resistive load)
- Class I, Class II, or Class II with Functional Earth input configurations
- ITE/ICT and medical (2 x MOPP) certified
- Auxiliary +12V output

Input

Input Voltage:	Specified: 85-264VAC, Nameplate: 100-240VAC
Input Frequency:	Specified: 47-63Hz, Nameplate: 50-60Hz
Input Current:	2.75A typ. @ 85VAC, 1.0A typ. @ 230VAC (full load)
No Load Input Power:	<150mW
Inrush Current:	<75A @ 230VAC (cold start @ 25°C)
Efficiency:	90 - 95% typ. (full load)
Power Factor:	>0.95 @ 115VAC, >0.90 @ 230VAC, 225W output >0.90 @ 115VAC, >0.85 @ 230VAC, 100W output

Output

Output Power:	225W (10CFM forced air) 140W (natural convection) Ratings are inclusive of aux output power
Turn-on Delay:	< 1 second @ 85VAC
Output Voltage Tolerance:	± 2.0% (worst case, set point + load/line regulation)
Load Regulation:	± 0.5% (measured at connector)
Line Regulation:	± 0.2% (measured at connector)
Ripple:	1% pk-pk (using a 47µF low-ESR cap + 0.1µF ceramic capacitor, measured @ 20MHz BW)
Transient Response:	<5% deviation (with 25% load step), recovery to within 1% in 1ms
Startup Overshoot:	<5% (full load)
Hold-up Time:	10ms min. (full load)
	12V ± 2V (10V min. / 14V max.), for $0A \leq I_{Aux} \leq 1.2A$
Aux Output Voltage Regulation:	Aux regulation guaranteed when main output power ≥ 15% of 225W rating (~34W). For main output power < 15%, aux output voltage may drop to < 50% of nominal rating, depending on load. For main output = 12V, aux output voltage is same as main output.
	1.2A (10CFM forced air)

Delivering leading edge, innovative power solutions for more than 30 years....

Model:GTM962250PWWWVX-XF

November 7, 2024

Aux Output Current:	0.8A (natural convection)
Output Indicator:	Green LED
Protections	
Input Protection:	MOV transient suppressor, dual fuses (line + neutral)
Over-Voltage Protection:	110-130%, latched-off, cycle AC to reset
Over-Current Protection:	110-140%, auto-recovery
Short Circuit Protection:	Non-latched with auto-recovery
Over-Temperature Protection:	NTC temperature sensor embedded in transformer, trip between 115 - 120°, latched-off, cyc
Environmental	
MTBF:	1,500,000 hours @ 25°C ambient, full load (Telcordia SR-332, Issue 3)
Operating Temperature:	-20°C to 50°C (full output power), -25°C to 80°C (derated)
Storage Temperature:	-30°C to 85°C
Humidity:	0% to 95% relative humidity, non-condensing
Altitude:	5000m max.
Vibration:	Conforms to EN60068-2-6, ISO80601-2, EN1789
Safety	
Dielectric Withstand Voltage:	4000VAC or 5656VDC from input to output 3000VAC or 4242VDC from input to earth
Touch Current:	3-conductor input - NC: <25µA, SFC: <200µA 2-conductor input - NC: <65µA, SFC: <140µA
Earth Leakage Current	3-conductor input: <200µA 2-conductor input: N/A
Means of Protection:	2 x MOPP
Primary-Secondary Bridging Capacitance:	Two IEC60384-14 certified Y1 capacitors in series
EMC	
Applicable Standards:	Medical: EN60601-1-2, 4th edition Emissions: EN55032, EN 55011, EN61000-6-3, EN61000-6-4, CISPR11/CISPR22 Immunity: EN55024, EN61000-6-1, EN61000-6-2
Conducted Emissions:	Class B, FCC Part 15, Class B (with resistive load)
Radiated Emissions:	Class B, FCC Part 15, Class B (with resistive load)
Harmonic Current Voltage Distortion:	EN61000-3-2, Class A
Voltage Fluctuations/Flicker:	EN61000-3-3
Electrostatic Discharge (ESD) Immunity:	EN61000-4-2, 10KV contact discharge, 20KV air discharge (applied to input or output termin
Radiated RF Immunity:	EN61000-4-3, 20V/m 80-2700MHz, 80% 1KHz AM, 80% 5Hz AM
EFT/Burst Immunity:	EN61000-4-4, 4KV/100kHz.

Delivering leading edge, innovative power solutions for more than 30 years....

Model:GTM962250PWWWVX-XF

November 7, 2024

Line Surge Immunity:	EN61000-4-5, 2KV differential, 4KV common-mode
Conducted RF Immunity:	EN61000-4-6, 3VRMS, (6VRMS in ISM/amateur bands), 80% 1KHz AM
Power Frequency Magnetic Field Immunity:	EN61000-4-8, 30A/m
Voltage Dip Immunity:	EN61000-4-11

Mechanical Formats

GTM962250P:	Open-frame
	No suffix: 2" x 4" style, 101.6*50.8*30.0mm, 170g
	-C suffix: 3" x 5" style, 127.0*64.8*30.0mm, 180g
	-D suffix: 4.22" x 7" style, 177.8*107.2*30.0mm, 190g
GTM962251P:	L-frame: 103.5*62.3*40.0mm, 230g
GTM962252P:	Cage: 103.5*62.3*40.0mm, 250g
Note 1:	The open-frame format meets the above EMC specifications as a standalone unit. However, help address other system level electrical/mechanical requirements.

Input/Output Connectors

Earth Terminal (J0):	Connector on PCB: Kang Yang PCH250 (0.250" x 0.031" Faston)
	Recommended mate: TE Connectivity/AMP 2-520184-2
	Note: Leave earth terminal disconnected for Class II input
Input Connector (J1):	Connector on PCB: JST B2P3-VH
	Pin 1: Line, Pin 2: Not used, Pin 3: Neutral
	Recommended mate: JST VAR-2 (housing), JST SVA-41T-P1.1 (terminals)
Main Output Connector (J2):	Connector on PCB: JST B6P-VH
	Pin 1: COM, Pin 2: COM, Pin 3: COM, Pin 4: +VOUT, Pin 5: +VOUT, Pin 6: +VOUT
	Recommended mate: JST VHR-6N (housing), JST SVH-21T-P1.1 (terminals)
Aux Output Connector (J3):	Connector on PCB: Molex 22-04-1021
	Pin 1: COM, Pin 2: +FAN
	Recommended mate: Molex 22-01-1022 (housing), Molex 2759 (terminals)

Special Options

- Custom labels/markings
- Short term output surge capability
- Reduced touch current
- Reduced output ripple
- Compliance to IPC-600, IPC-610, IPC-6012 Class 2 or 3
- IEC61000-3-2 Class-C line harmonics for LED lighting applications
- Non-latching (auto-recover) over-temperature protection
- Potentiometer to adjust/trim output voltage
- Custom aux output voltages (5V to 12V), available for main output voltages from 12-24V

Fan Airflow

Delivering leading edge, innovative power solutions for more than 30 years....

Model:GTM962250PWWWVX-XF

November 7, 2024

- For full 225W output power, the fan should provide at least 10CFM in the direction noted below.

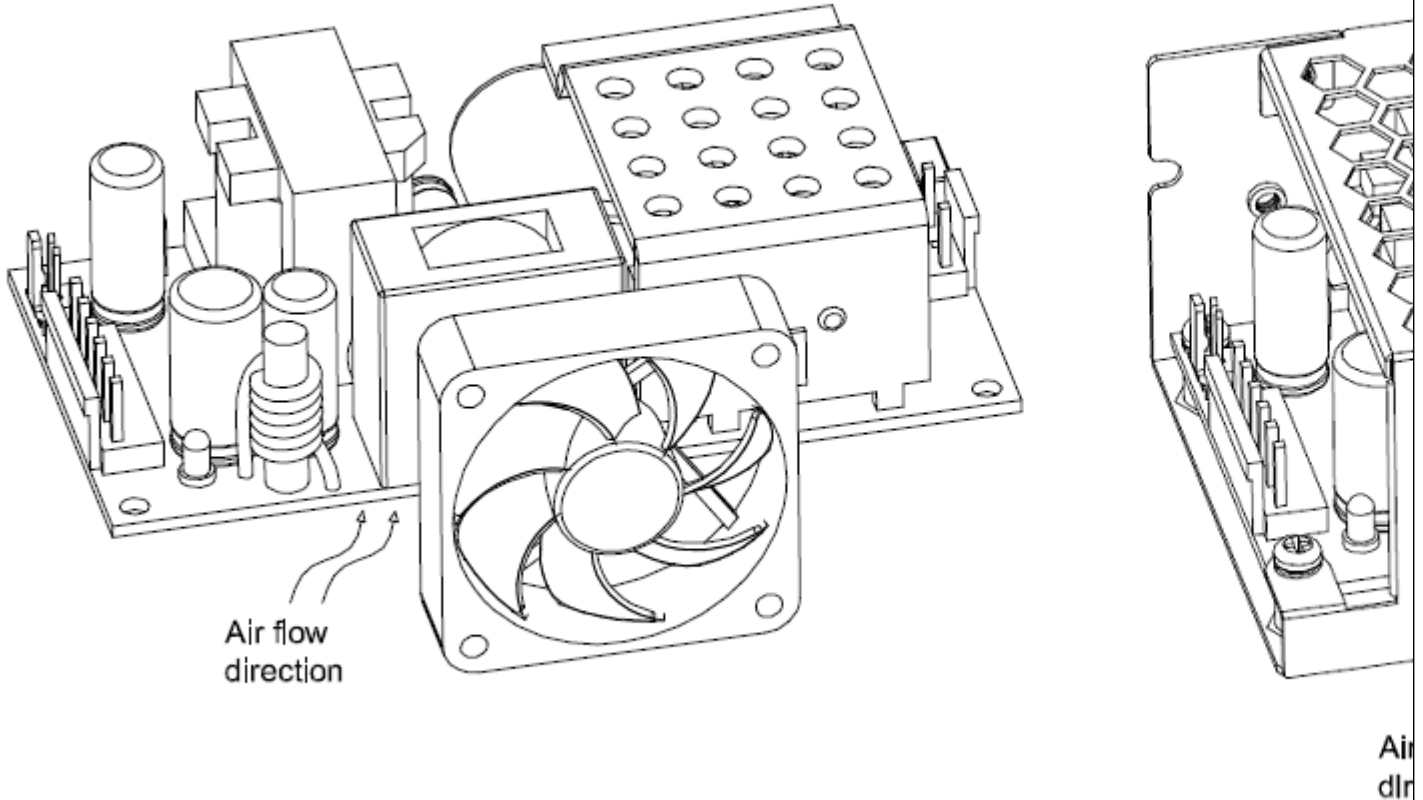

Delivering leading edge, innovative power solutions for more than 30 years....

Model:GTM962250PWWWVX-XF

November 7, 2024

DERATING CURVE

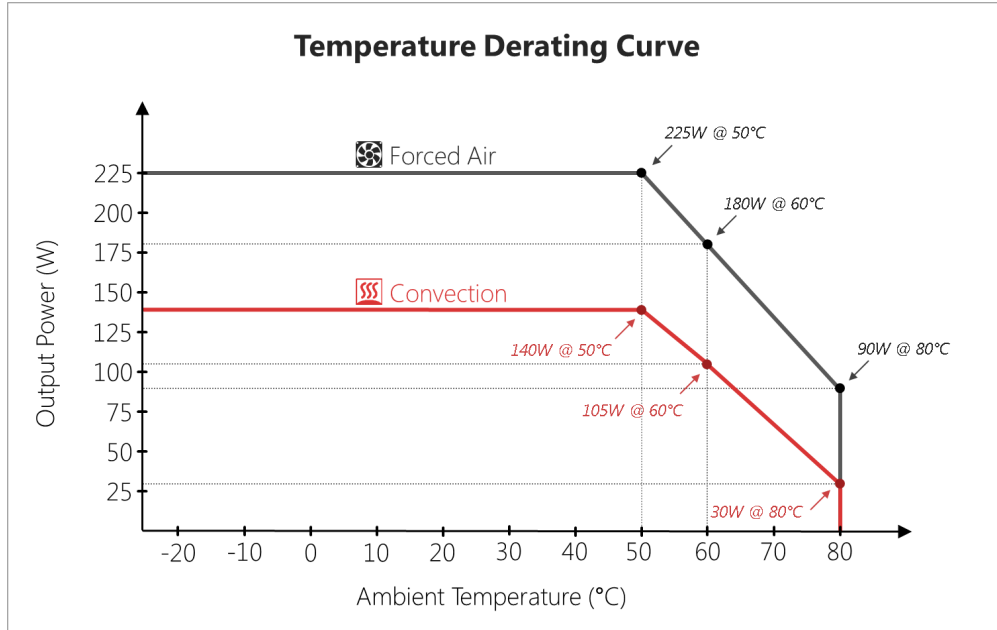

Delivering leading edge, innovative power solutions for more than **30** years....

Model:GTM962250PWWWVX-XF

November 7, 2024

INPUT CONFIGURATION

Description



Optional Input Wiring Kits are available:

PN/Ordering No	Length	End A	End B
C810070M6VAR2(R)	60	IEC 60320 C8	JST VAR-2
C1410070M6VAR2(R)	60	IEC 60320 C13	JST VAR-2
VAR2210070M7VAR2(R)	73	JST VAR-2	JST VAR-2





Custom lengths, construction, cable types, ferrites, filters, and termination available upon request.

Delivering leading edge, innovative power solutions for more than **30** years....

Model:GTM962250PWWWVX-XF

November 7, 2024







Approvals

Logo	Description
	Attention Mark / Refer to operating manual for operating and service instructions
No Logo Applicable	CB for IEC 60601-1:2005 (Third Edition) + CORR. 1 (2006) + CORR. 2 (2007) + AM1 (2012) or IEC 60601-1 (2012 reprint) (Ed 3.1) up to 48V only
No Logo Applicable	CB for IEC 60950-1:2005 (Second Edition) + Am 1:2009 + Am 2:2013
No Logo Applicable	IEC 60335-1:2010+A1+A2
No Logo Applicable	IEC 61558-1:2005+A1, IEC 61558-2-16:2009+A1 (pending)
No Logo Applicable	CB for IEC 62368-1:2014 (Second Edition)
	CCC GB17625.1-2012, GB4943.1-2011, GB/T9254-2008
	CE Certification
	Audio/Video, Information And Communication Technology Equipment - Part 1: Safety Requirements [UL 62368-1:2014 Ed.2] Audio/Video, Information And Communication Technology Equipment - Part 1: Safety Requirements [CSA C22.2#62368-1:2014 Ed.2]
	CHINA SJ/T 11364-2014, China RoHS Chart: http://www.globtek.com/pdf/F-GT-DJD-8.4.1-006%20China%20RoHS%20Declaration%205-20-22.pdf

Delivering leading edge, innovative power solutions for more than **30** years....

Model:GTM962250PWWWVX-XF



November 7, 2024

Conforms to UL STD. 60950-1 Certified to CSA STD C22.2 NO.60950-1	Conforms to UL STD. 60950-1 Certified to CSA STD C22.2 NO.60950-1
Conforms to UL STD. 62368-1 Certified to CSA STD C22.2 NO.62368-1	Conforms to UL STD. 62368-1 Certified to CSA STD C22.2 NO.62368-1
	Certification # TC RU AR46.B.75423 Custom Union of Russia, Belarus and Kazakhstan
	Medical Elec. Equip.- Part 1-11: Gen. Req. For Basic Safety & Essential Perf.- Collateral Standard - Req. For Medical Elec. Equip. & Medical Elec. Systems Used In The Home Healthcare Environment [IEC 60601-1-11:2015 Ed.2]
	Indoor Use Only - Mark is on the label or Molded in the case
EFFICIENCY LEVEL 	Efficiency: complies to section 301 of Energy Independence and Security Act (EISA) complies with Energy Star tier 2 (North America), ECP tier 2 (China), MEPS tier 2 (Australia), Code of Conduct (Europe)
	Morocco SDoC declaration http://www.globtek.info/certs/Morocco%20SDoC%20Declaration/
RoHS	Specifications of directive 2011/65/EU Annex VI (ROHS-2) with amendment 2015/863-EU (ROHS-3) http://www.ce-mark.com/Rohs%20final.pdf
	UKCA Certification

Delivering leading edge, innovative power solutions for more than **30** years....

Model:GTM962250PWWWVX-XF

November 7, 2024

 10276	Ukraine UKRSepra (Document: www.globtek.com/html/iso_certificates/GT_Ukraine.pdf)
	Japan: Voluntary Control Council for Interference (VCCI)
	WEEE: Complies with EU 2012/19/EU (http://ec.europa.eu/environment/waste/weee/index_en.htm) Mark is on the label or Molded in the case