

### Peak Emission Wavelength: 365nm

The 365nm UV emitter is specifically designed for applications requiring high power output and accuracy in a dome lensed metal package. Custom package solutions and sorting are available.

#### FEATURES

- > High Output Power
- > Metal Can Domed
- > High Reliability / Precise Die Center
- > Narrow Beam Angle

#### APPLICATIONS

- > Currency Validation
- > UV Curing / Bar-code Reader
- > Counterfeit Detection
- > Medical Phototherapy

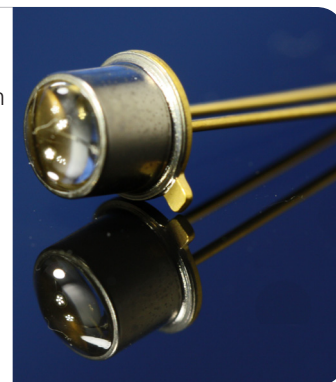

### Absolute Maximum Ratings (Ta=25°C)



ITEMS	SYMBOL	RATINGS	UNIT
Forward Current (DC)	IF	15	mA
Forward Current (Pulse)*1	IFP	30	mA
Reverse Voltage	VR	5	V
Power Dissipation	PD	60	mW
Operating Temperature Range	Topr	-20 ~ +80	°C
Storage Temperature Range	Tstg	-30 ~ +100	°C
Junction Temperature Range	Tj	100	°C
Lead Soldering Temperature*2	Tls	260	°C

\*1: Tw=10µsec, T=10msec. \*2: Time 5 Sec max, Position: up to 3mm from the body.

### Electrical & Optical Characteristics (Ta = 25°C)

ITEMS	SYMBOL	CONDITIONS	MIN	TYP	MAX	UNIT
Power Output	PO	IF=10mA	--	1.5	--	mW
Forward Voltage	VF	IF=10mA	--	3.5	--	V
Reverse Current	IR	VR=5V	--	--	80	mA
Peak Emission Wavelength	$\lambda_p$	IF=10mA	--	365	--	nm
Spectral Line Half Width	$\Delta\lambda$	IF=10mA	--	15	--	nm
Half Intensity Beam Angle	$\Theta$	IF=10mA	--	±5	--	deg

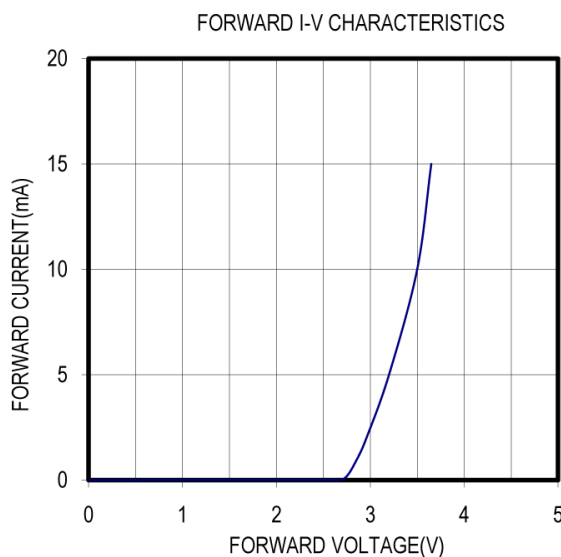
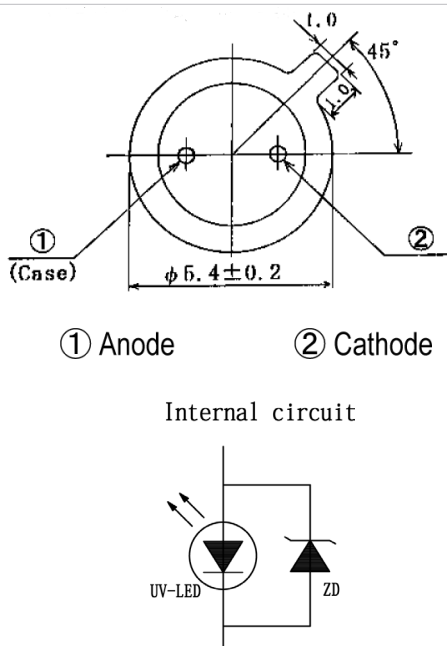
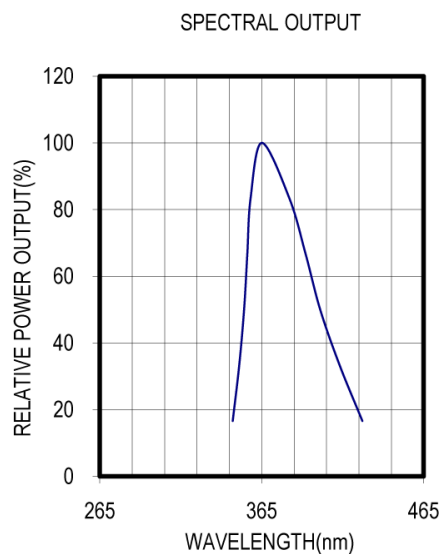
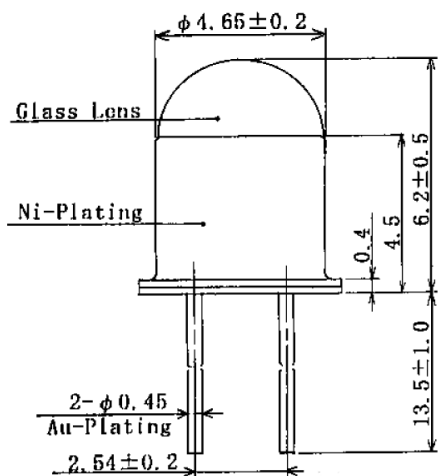

Unit: mm, Tolerance:  $\pm 0.15$

RELATIVE POWER vs FORWARD CURRENT

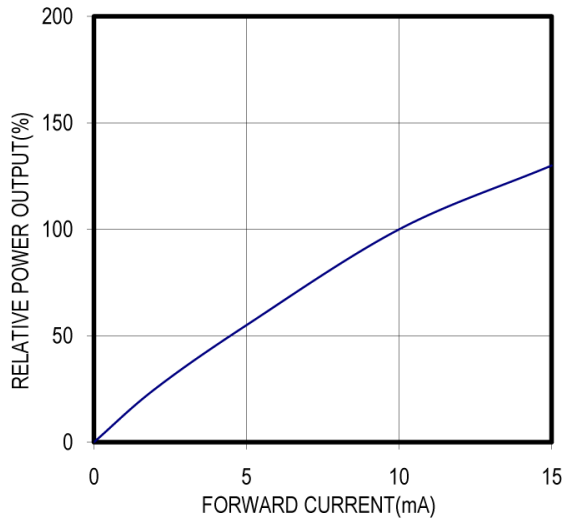

RADIATION PATTERN

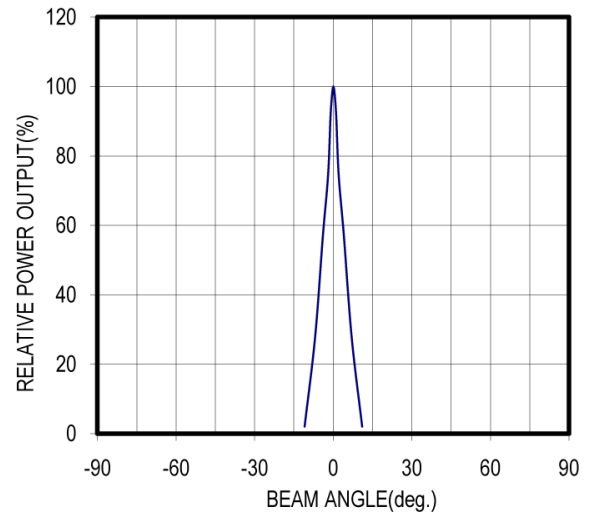

THERMAL DERATING CURVE

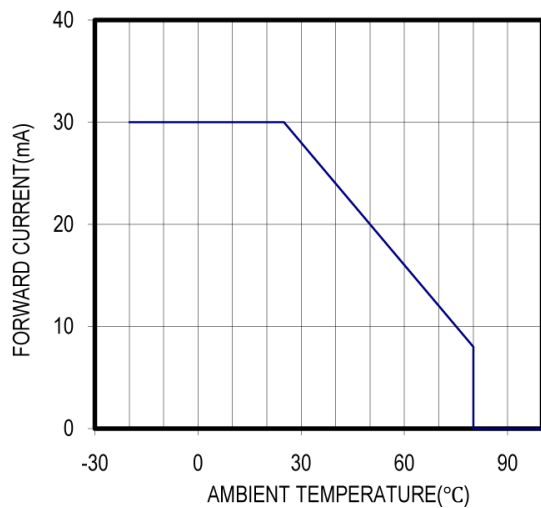



 **CAUTION**

1. LEDs emit very strong UV radiation during operation.
2. Don't look directly into the LED light when in operation as UV radiation can harm your eyes.
3. To prevent even inadequate exposure, wear protective eyewear.
4. If LEDs are embedded in devices, please indicate warning labels against the UV LED used.
5. Avoid prolonged exposure to skin or other tissue during operation.
6. Keep out of reach of children.
7. Take appropriate precautions around pets and other living organisms to avoid UV exposure.
8. Specification and dimension are subject to change without notice.