

OPAx607-Q1, Automotive, 50-MHz, Rail to Rail Output CMOS Operational Amplifier

1 Features

- Qualified for automotive applications
- AEC-Q100 qualified with the following results:
 - Temperature grade 1: -40°C to $+125^{\circ}\text{C}$, TA
- Gain bandwidth product (GBW): 50 MHz
- Quiescent current: 900 μA (typical)
- Input offset drift: 1.5 $\mu\text{V}/^{\circ}\text{C}$ (maximum)
- Offset voltage: 120 μV (typical)
- Input bias current: 10 pA (maximum)
- Rail-to-rail output (RRO)
- Supply range : 2.2 V to 5.5 V

2 Applications

- [DC/DC converter](#)
- [Inverter and motor control](#)
- [On-Board \(OBC\) and wireless charger](#)
- [e-Turbo](#)
- [HVAC compressor module](#)
- [Gesturing](#)

3 Description

The OPA607-Q1 and OPA2607-Q1 devices are decompensated, minimum gain of 6 V/V stable, general-purpose CMOS operational amplifiers with low noise of 3.8 $\text{nV}/\sqrt{\text{Hz}}$ and a GBW of 50 MHz. The low voltage offset drift (dVOS/dT) and wide bandwidth of the OPAx607-Q1 devices make them attractive for low cost general-purpose applications like low side current sensing and TIA (transimpedance amplifier). The high-impedance CMOS inputs make the OPAx607-Q1 devices ideal amplifiers to interface with sensors with high output impedance (for example, piezoelectric transducers).

The rail-to-rail output (RRO) of the OPAx607-Q1 devices can swing up to 8 mV from the supply rails, maximizing dynamic range.

The OPAx607-Q1 is optimized for low supply voltage operation as low as 2.2 V (± 1.1 V) and up to 5.5 V (± 2.75 V), and is specified over the temperature range of -40°C to $+125^{\circ}\text{C}$.

Device Information⁽¹⁾

PART NUMBER	PACKAGE	BODY SIZE (NOM)
OPA607-Q1	SOT23 (5)	2.90 mm × 1.60 mm
OPA2607-Q1	VSSOP (8)	3.00 mm × 3.00 mm

- (1) For all available packages, see the orderable addendum at the end of the data sheet.

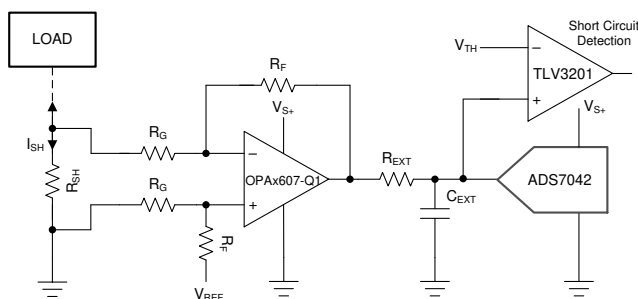

OPAx607-Q1 for Current-Sensing Application

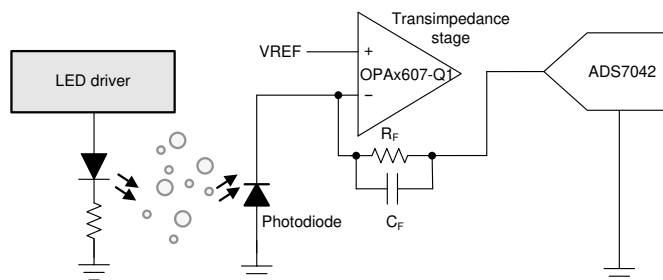

OPAx607-Q1 for Transimpedance Application



Table of Contents

1 Features	1	9 Application and Implementation	19
2 Applications	1	9.1 Application Information.....	19
3 Description	1	9.2 Typical Applications.....	19
4 Revision History	2	10 Power Supply Recommendations	25
5 Device Comparison	3	11 Layout	26
6 Pin Configuration and Functions	4	11.1 Layout Guidelines.....	26
7 Specifications	5	11.2 Layout Examples.....	26
7.1 Absolute Maximum Ratings	5	12 Device and Documentation Support	27
7.2 ESD Ratings	5	12.1 Device Support.....	27
7.3 Recommended Operating Conditions	5	12.2 Documentation Support.....	27
7.4 Thermal Information	5	12.3 Receiving Notification of Documentation Updates..	27
7.5 Electrical Characteristics	6	12.4 Support Resources.....	27
7.6 Typical Characteristics.....	8	12.5 Trademarks.....	27
8 Detailed Description	14	12.6 Electrostatic Discharge Caution.....	27
8.1 Overview.....	14	12.7 Glossary.....	27
8.2 Functional Block Diagram.....	14	13 Mechanical, Packaging, and Orderable	
8.3 Feature Description.....	15	Information	27
8.4 Device Functional Modes.....	18		

4 Revision History

NOTE: Page numbers for previous revisions may differ from page numbers in the current version.

Changes from Revision * (February 2021) to Revision A (April 2021)	Page
• Updated the release status from <i>advanced information</i> to <i>production data</i>	1

5 Device Comparison

Table 5-1. OPA607-Q1 vs OPA2607-Q1

DEVICE	NO. OF CHANNELS	PACKAGE LEADS	
		VSSOP (DGK)	SOT-23 (DBV)
OPA607-Q1	1	—	5
OPA2607-Q1	2	8	—

Table 5-2. OPAX607-Q1 vs Other Automotive Op-Amps from TI

DEVICE	INPUT	OFFSET DRIFT ($\mu\text{V}/^\circ\text{C}$, TYP)	MINIMUM STABLE GAIN (V/V)	I_Q / CHANNEL (mA, TYP)	GBW (MHz)	SLEW RATE (V/ μs)	VOLTAGE NOISE (nV/ $\sqrt{\text{Hz}}$)
OPAx365-Q1	CMOS	1	1	4.6	50	25	4.5
OPAx607-Q1	CMOS	0.3	6	0.9	50	24	3.8
OPAx836-Q1	Bipolar	1.1	1	0.95	110	240	4.6

6 Pin Configuration and Functions

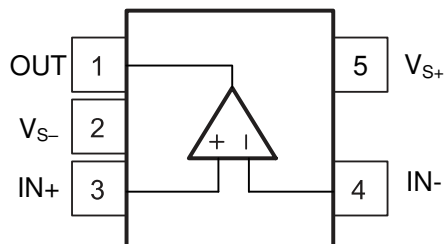

**Figure 6-1. DBV Package
5-Pin SOT-23
Top View**

Pin Functions – Single Channel

PIN		I/O	DESCRIPTION
NAME	DBV		
IN-	4	I	Non Inverting Input
IN+	3	I	Inverting Input
OUT	1	O	Output
V _{S-}	2	—	Negative supply or ground (for single-supply operation)
V _{S+}	5	—	Positive supply

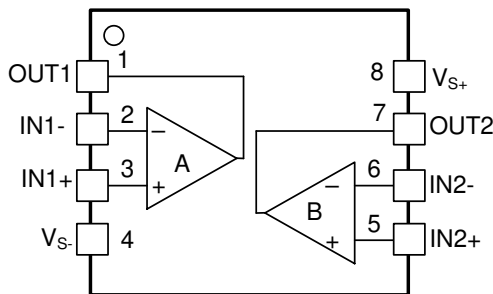

**Figure 6-2. OPA2607-Q1 DGK
8-Pin, VSSOP
Top View**

Pin Functions – Dual Channel

PIN		I/O	DESCRIPTION
NAME	DGK		
IN1-	2	I	Inverting input, channel 1
IN1+	3	I	Noninverting input, channel 1
IN2-	6	I	Inverting input, channel 2
IN2+	5	I	Noninverting input, channel 2
OUT1	1	O	Output, channel 1
OUT2	7	O	Output, channel 2
V _{S-}	4	—	Negative (lowest) supply or ground (for single-supply operation)
V _{S+}	8	—	Positive (highest) supply

7 Specifications

7.1 Absolute Maximum Ratings

Over operating free-air temperature range (unless otherwise noted)⁽¹⁾

		MIN	MAX	UNIT
$(V_{S+}) - (V_{S-})$	Supply voltage, V_S		6	V
V_{IN+}, V_{IN-}	Input voltage	$(V_{S-}) - 0.5$	$(V_{S+}) + 0.5$	V
V_{ID}	Differential input voltage ⁽⁴⁾		±5	V
I_I	Continuous input current ⁽²⁾		±10	mA
I_O	Continuous output current ⁽³⁾		±20	mA
	Continuous power dissipation	See Thermal Information		
T_J	Maximum junction temperature		150	°C
T_A	Operating free-air temperature	-40	150	°C
T_{stg}	Storage temperature	-65	150	°C

- (1) Stresses above these ratings may cause permanent damage. Exposure to absolute maximum conditions for extended periods may degrade device reliability. These are stress ratings only, and functional operation of the device at these or any other conditions beyond those specified is not supported.
- (2) Input terminals are diode-clamped to the power-supply rails. Input signals that can swing more than 0.5 V beyond the supply rails should be current limited to 10 mA or less.
- (3) Short-circuit to ground, one amplifier per package.
- (4) Long term drift of offset voltage (> 1mV) if a differential input in excess of ≈ 2V is applied continuously between the IN+ and IN- pins at elevated temperatures.

7.2 ESD Ratings

			VALUE	UNIT
$V_{(ESD)}$	Electrostatic discharge	Human-body model (HBM), per AEC Q100-002 ⁽¹⁾	±2000	V
		Charged-device model (CDM), per AEC Q100-011	±1000	

- (1) AEC Q100-002 indicates that HBM stressing shall be in accordance with ANSI/ESDA/JEDEC JS-001 Specification

7.3 Recommended Operating Conditions

over operating free-air temperature range (unless otherwise noted)

		MIN	NOM	MAX	UNIT
V_S	Supply voltage ($V_{S+}) - (V_{S-})$	2.2		5.5	V
		±1.1		±2.75	
T_A	Ambient operating temperature	-40	25	125	°C

7.4 Thermal Information

THERMAL METRIC ⁽¹⁾		OPA607-Q1		UNIT
		DBV (SOT23)	DGK (VSSOP8)	
		5 PINS	8 PINS	
$R_{\theta JA}$	Junction-to-ambient thermal resistance	196.5	179	°C/W
$R_{\theta JC(top)}$	Junction-to-case (top) thermal resistance	118.7	71	°C/W
$R_{\theta JB}$	Junction-to-board thermal resistance	64.5	101	°C/W
Ψ_{JT}	Junction-to-top characterization parameter	41.1	13.7	°C/W
Ψ_{JB}	Junction-to-board characterization parameter	64.2	100	°C/W

- (1) For more information about traditional and new thermal metrics, see the [Semiconductor and IC Package Thermal Metrics](#) application report.

7.5 Electrical Characteristics

At $T_A = 25^\circ\text{C}$, $V_S = 2.2\text{ V to }5.5\text{ V}$, $G = 6\text{ V/V}^{(3)}$, $R_F = 5\text{ k}\Omega$, $C_F = 2.5\text{ pF}$, $V_{CM} = (V_S / 2) - 0.5\text{ V}$, $C_L = 10\text{ pF}$, $R_L = 10\text{ k}\Omega$ connected to $(V_S / 2) - 0.5\text{ V}$ and PD connected to (V_{S+}) (unless otherwise noted)⁽¹⁾

PARAMETER		TEST CONDITIONS	MIN	TYP	MAX	UNIT
OFFSET VOLTAGE						
V_{OS}	Input offset voltage			± 0.1	± 0.6	mV
		$T_A = -40^\circ\text{C to }+125^\circ\text{C}^{(2)}$		± 0.1	± 0.7	
dV_{OS}/dT	Input offset voltage drift ⁽²⁾	$T_A = -40^\circ\text{C to }+125^\circ\text{C}$		± 0.3	± 1.5	$\mu\text{V}/^\circ\text{C}$
PSRR	Power-supply rejection ratio	$V_S = 2.2\text{ V to }5.5\text{ V}$	95	110		dB
		$T_A = -40^\circ\text{C to }+125^\circ\text{C}$	95			
INPUT VOLTAGE RANGE						
V_{CM}	Common-mode voltage range		(V_{S-})		$(V_{S+}) - 1.1$	V
CMRR	Common-mode rejection ratio	$(V_{S-}) < V_{CM} < (V_{S+}) - 1.1\text{ V}$	90	100		dB
		$T_A = -40^\circ\text{C to }+125^\circ\text{C}$	86			
INPUT BIAS CURRENT						
I_B	Input bias current ⁽²⁾			± 3	± 10	pA
		$T_A = -40^\circ\text{C to }125^\circ\text{C}$		See Figure 7-27		
I_{OS}	Input offset current ⁽²⁾			± 3	± 10	
NOISE						
	Input voltage noise (peak-to-peak)	$f = 0.1\text{ Hz to }10\text{ Hz}$		1.6		μV_{PP}
e_N	Input voltage noise density	$f = 10\text{ kHz}$, 1/f corner at 1 kHz		3.8		$\text{nV}/\sqrt{\text{Hz}}$
i_N	Input current noise density	$f = 1\text{ kHz}$		46		$\text{fA}/\sqrt{\text{Hz}}$
INPUT IMPEDANCE						
C_{IN}	Differential			11.5		pF
	Common-mode			5.5		
OPEN-LOOP GAIN						
A_{OL}	Open-loop voltage gain	$(V_{S-})+400\text{ mV} < V_{OUT} < (V_{S+})-400\text{ mV}$	110	130		dB
		$T_A = -40^\circ\text{C to }+125^\circ\text{C}$	100			
	Phase margin			65		$^\circ$
AC Characteristics ($V_S = 5\text{ V}$)						
SSBW	Small-signal bandwidth	$V_{OUT} = 20\text{ mV}_{pp}$		10		MHz
GBW	Gain-bandwidth product	$G = 20\text{ V/V}$		50		
SR	Slew rate	3-V output step (10-90%)		24		V/ μs
t_S	Settling time	To 0.1%, 3-V step, $G = 40$		1		μs
		To 0.01%, 3-V step, $G = 40$		1.8		
	Overdrive recovery time	$V_{IN+} \times \text{Gain} > V_S$		0.25		μs
THD+N	Total Harmonic Distortion + Noise ⁽⁴⁾	$V_{OUT} = 2\text{ V}_{PP}$, $f = 1\text{ kHz}$, $R_L = 10\text{ k}\Omega$		-103		dB
		$V_{OUT} = 2\text{ V}_{PP}$, $f = 20\text{ kHz}$, $R_L = 10\text{ k}\Omega$		-91.5		
		$V_{OUT} = 2\text{ V}_{PP}$, $f = 1\text{ kHz}$, $R_L = 1\text{ k}\Omega$		-96		
		$V_{OUT} = 2\text{ V}_{PP}$, $f = 20\text{ kHz}$, $R_L = 1\text{ k}\Omega$		-72.8		
HD2	Second-order harmonic distortion	$V_{OUT} = 2\text{ V}_{PP}$, $f = 20\text{ kHz}$		-105		dBc
HD3	Third-order harmonic distortion	$V_{OUT} = 2\text{ V}_{PP}$, $f = 20\text{ kHz}$		-95		

7.5 Electrical Characteristics (continued)

At $T_A = 25^\circ\text{C}$, $V_S = 2.2\text{ V to }5.5\text{ V}$, $G = 6\text{ V/V}^{(3)}$, $R_F = 5\text{ k}\Omega$, $C_F = 2.5\text{ pF}$, $V_{CM} = (V_S / 2) - 0.5\text{ V}$, $C_L = 10\text{ pF}$, $R_L = 10\text{ k}\Omega$ connected to $(V_S / 2) - 0.5\text{ V}$ and PD connected to (V_{S+}) (unless otherwise noted)⁽¹⁾

PARAMETER		TEST CONDITIONS	MIN	TYP	MAX	UNIT
OUTPUT						
	Output voltage swing from supply rails			8	12	mV
		$T_A = -40^\circ\text{C to }+125^\circ\text{C}$			12	
I_{SC}	Output Short-circuit current			60		mA
Z_O	Open-loop output impedance	$f = 1\text{ MHz}$		500		Ω
POWER SUPPLY						
I_Q	Quiescent current per amplifier	$I_O = 0\text{ mA}$		900	1100	μA
		$T_A = -40^\circ\text{C to }+125^\circ\text{C}$			1200	

- (1) Parameters with minimum or maximum specification limits are 100% production tested at 25°C , unless otherwise noted. Over temperature limits are based on characterization and statistical analysis.
- (2) Specified by design or/and characterization; not production tested.
- (3) All Gains (G) mentioned are in V/V unless otherwise noted.
- (4) Lowpass-filter bandwidth is 92kHz for $f = 20\text{ kHz}$ and 20 kHz for $f = 1\text{ kHz}$.

7.6 Typical Characteristics

At $T_A = +25^\circ\text{C}$, $V_S = 5.5\text{ V}$, $R_L = 10\text{ k}\Omega$, $R_F = 5\text{ k}\Omega$, $C_F = 2.5\text{ pF}$, $V_{CM} = \text{midsupply} - 0.5\text{ V}$, $G = 6\text{ V/V}$ (unless otherwise noted).

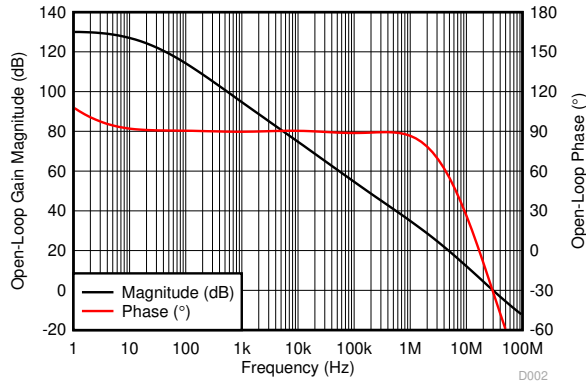

Figure 7-1. Open Loop Gain and Phase vs Frequency

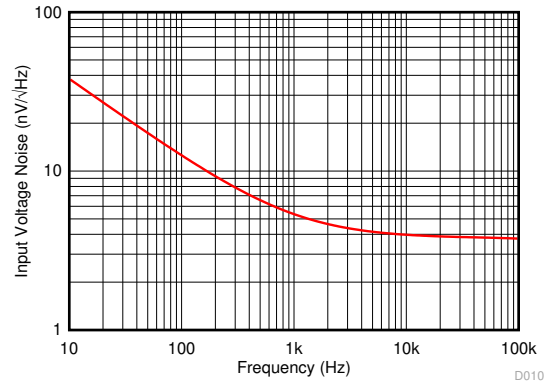

Figure 7-2. Input Voltage Noise Density vs Frequency

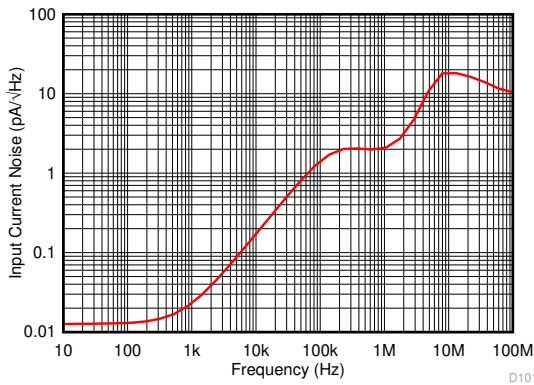

Figure 7-3. Input Current Noise Density vs Frequency

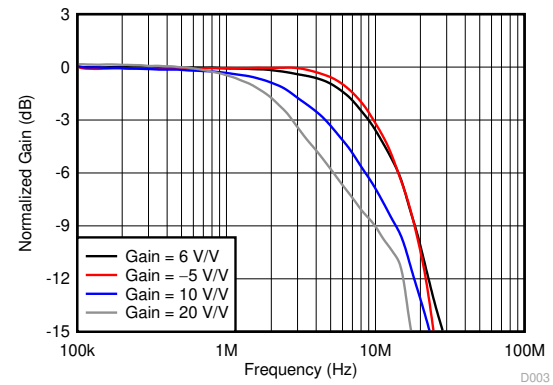

Figure 7-4. Small-Signal Frequency Response vs Gain

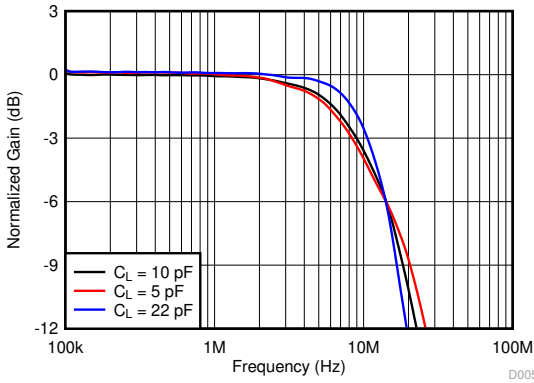

Figure 7-5. Small-Signal Frequency Response vs Capacitive Load

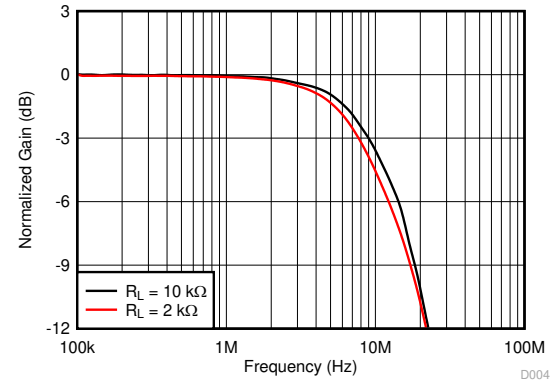

Figure 7-6. Small-Signal Frequency Response vs Output Load

7.6 Typical Characteristics (continued)

At $T_A = +25^\circ\text{C}$, $V_S = 5.5\text{ V}$, $R_L = 10\text{ k}\Omega$, $R_F = 5\text{ k}\Omega$, $C_F = 2.5\text{ pF}$, $V_{CM} = \text{midsupply} - 0.5\text{ V}$, $G = 6\text{ V/V}$ (unless otherwise noted).

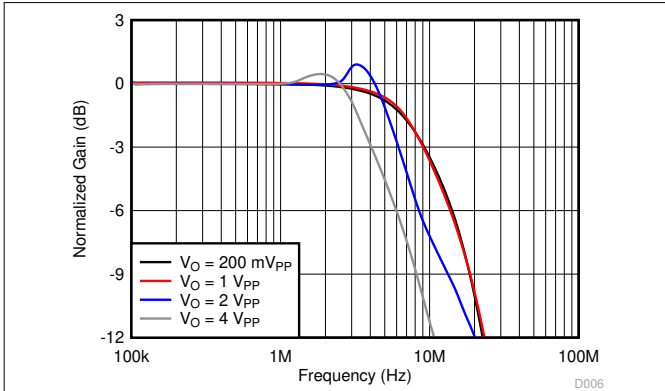

Figure 7-7. Large-Signal Frequency Response vs Output Voltage

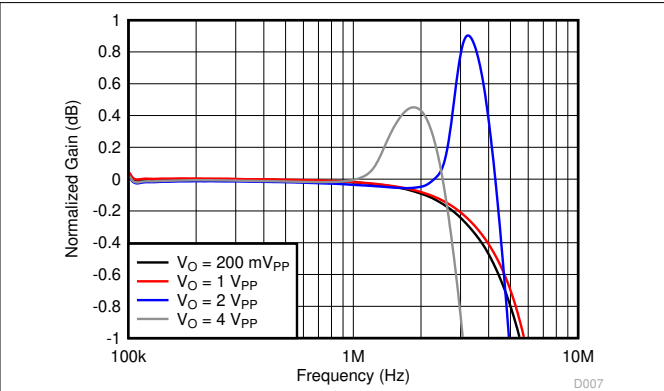

Figure 7-8. Large-Signal Response Flatness vs Frequency

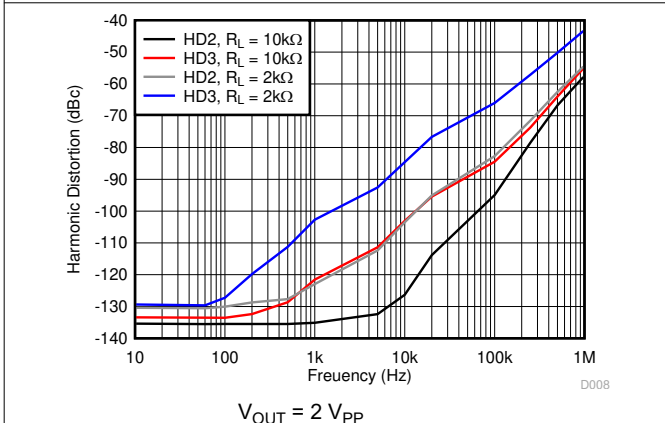

Figure 7-9. Harmonic Distortion vs Frequency

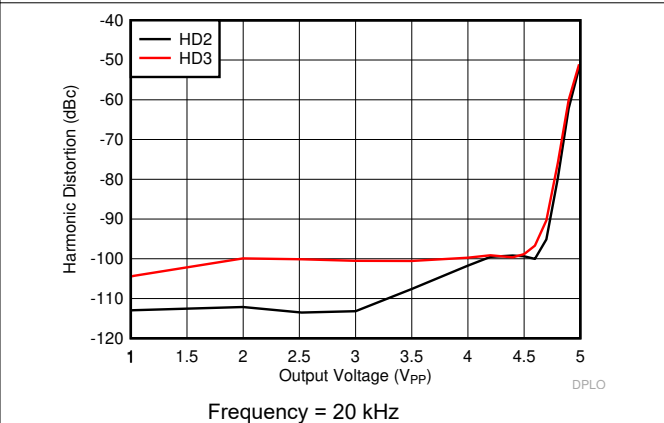

Figure 7-10. Harmonic Distortion vs Output Voltage

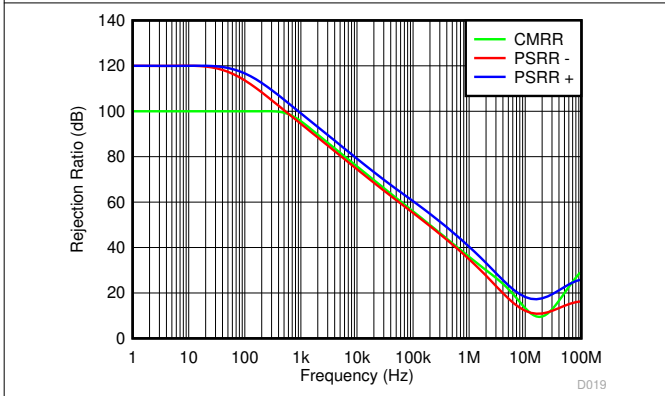

Figure 7-11. Rejection Ratio vs frequency

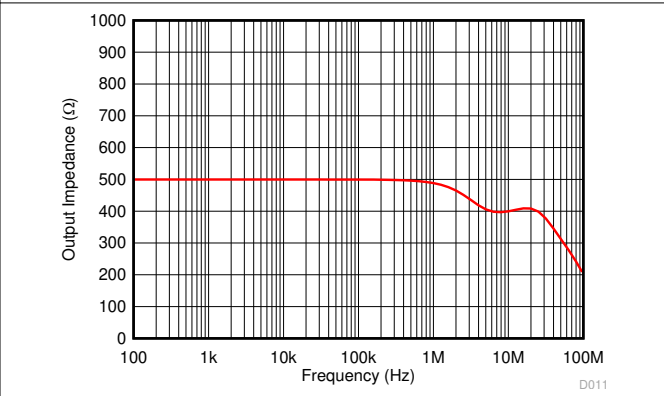

Figure 7-12. Open Loop Output Impedance vs Frequency

7.6 Typical Characteristics (continued)

At $T_A = +25^\circ\text{C}$, $V_S = 5.5\text{ V}$, $R_L = 10\text{ k}\Omega$, $R_F = 5\text{ k}\Omega$, $C_F = 2.5\text{ pF}$, $V_{CM} = \text{midsupply} - 0.5\text{ V}$, $G = 6\text{ V/V}$ (unless otherwise noted).

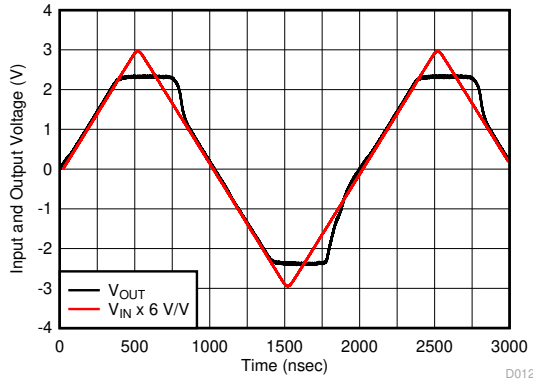
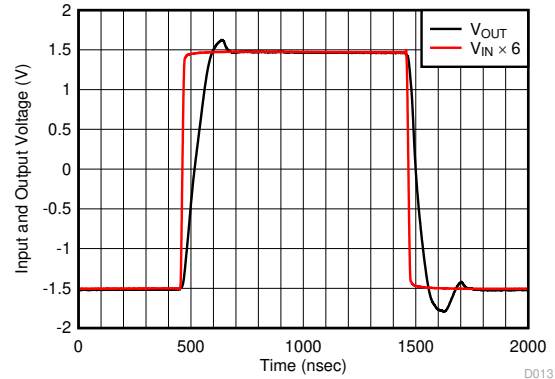
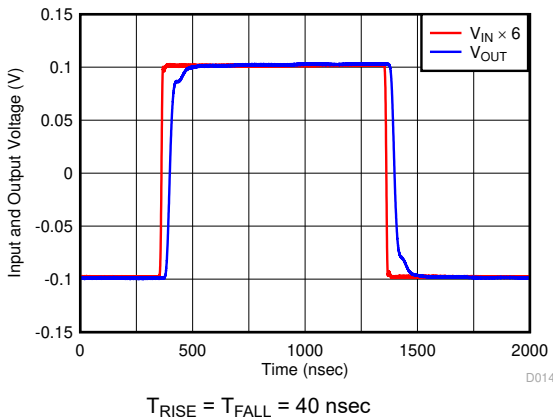

Figure 7-13. Output Overdrive Recovery



$T_{RISE} = 1\ \mu\text{sec}$, $T_{FALL} = 0.7\ \mu\text{sec}$

Figure 7-14. Large-Signal Transient Response



$T_{RISE} = T_{FALL} = 40\text{ nsec}$

Figure 7-15. Small-Signal Transient Response

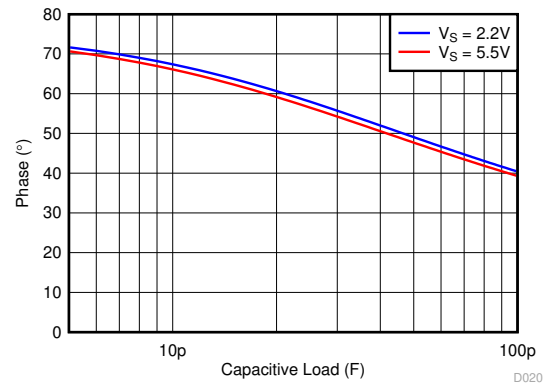
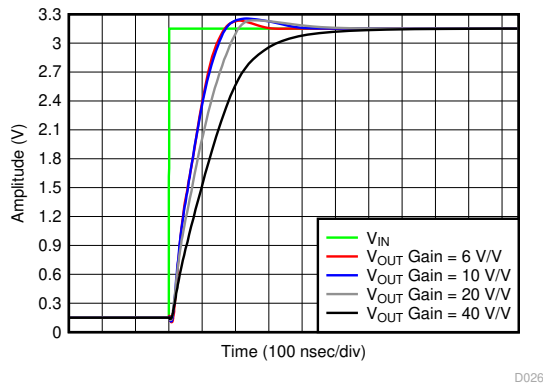

Figure 7-16. Phase Margin vs Capacitive Load



Simulated

Figure 7-17. Step Settling Time

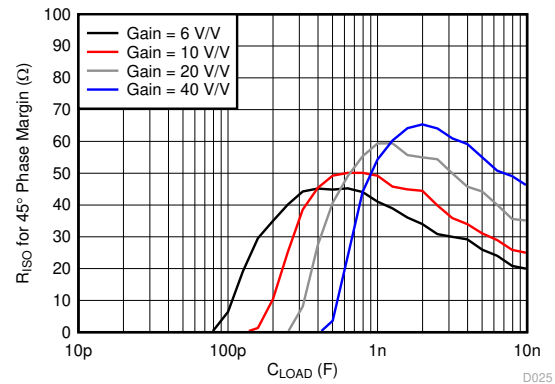

Figure 7-18. Recommended Isolation Resistor vs Capacitive Load

7.6 Typical Characteristics (continued)

At $T_A = +25^\circ\text{C}$, $V_S = 5.5\text{ V}$, $R_L = 10\text{ k}\Omega$, $R_F = 5\text{ k}\Omega$, $C_F = 2.5\text{ pF}$, $V_{CM} = \text{midsupply} - 0.5\text{ V}$, $G = 6\text{ V/V}$ (unless otherwise noted).

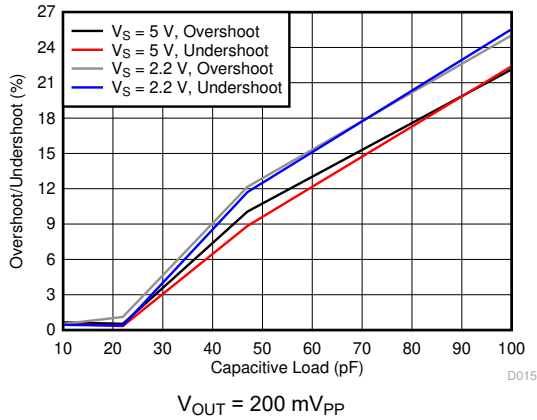

Figure 7-19. Overshoot vs Capacitive Load

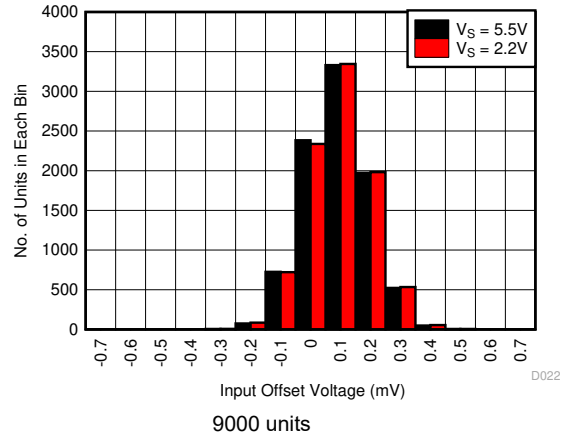

Figure 7-20. Input Offset Voltage Distribution

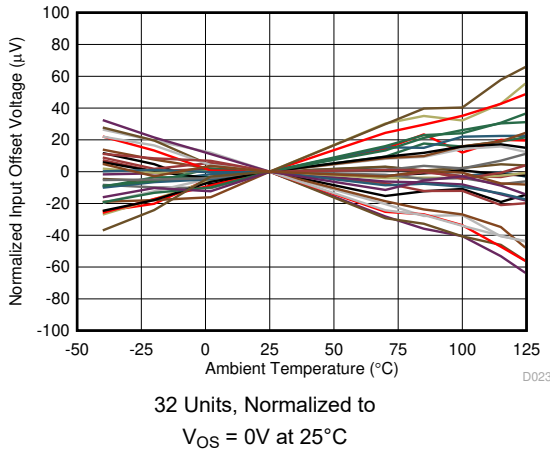

Figure 7-21. Input Offset Voltage vs Temperature

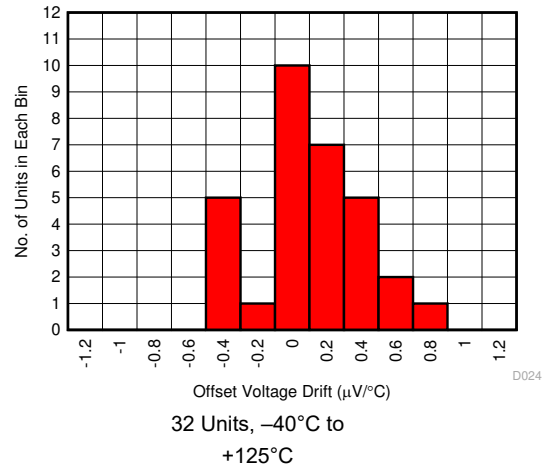

Figure 7-22. Input Offset Drift Distribution

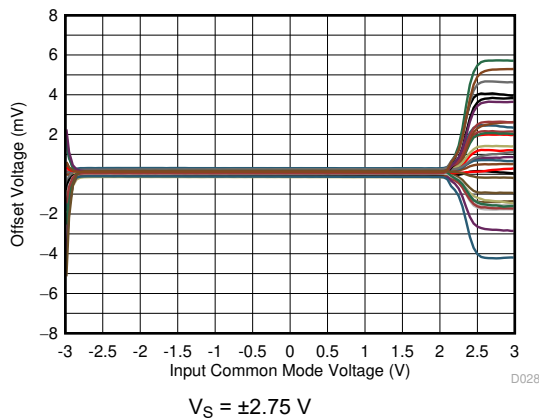

Figure 7-23. Input Offset vs Common Mode Voltage

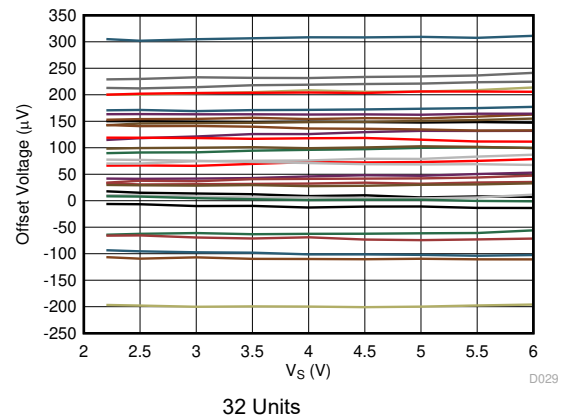

Figure 7-24. Input Offset vs Supply

7.6 Typical Characteristics (continued)

At $T_A = +25^\circ\text{C}$, $V_S = 5.5\text{ V}$, $R_L = 10\text{ k}\Omega$, $R_F = 5\text{ k}\Omega$, $C_F = 2.5\text{ pF}$, $V_{CM} = \text{midsupply} - 0.5\text{ V}$, $G = 6\text{ V/V}$ (unless otherwise noted).

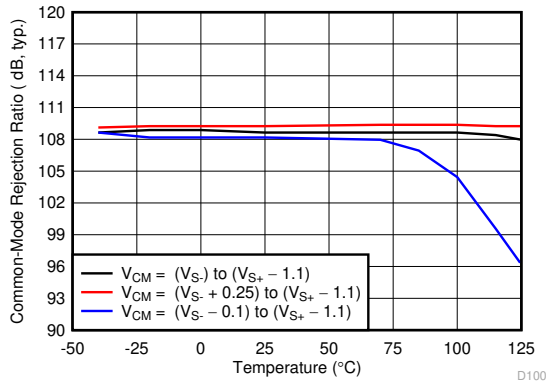

Figure 7-25. Common Mode Rejection Ratio vs Temperature

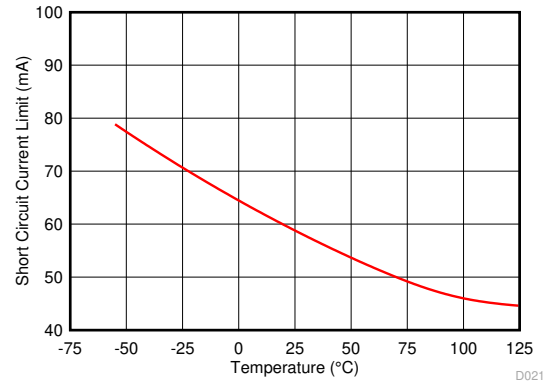

Figure 7-26. Short-Circuit Current vs Temperature

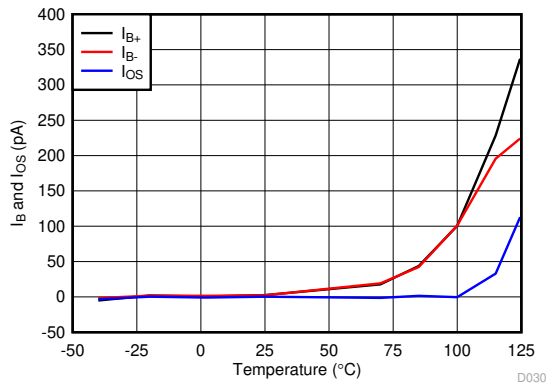

Figure 7-27. Input Bias and Offset Current vs Temperature

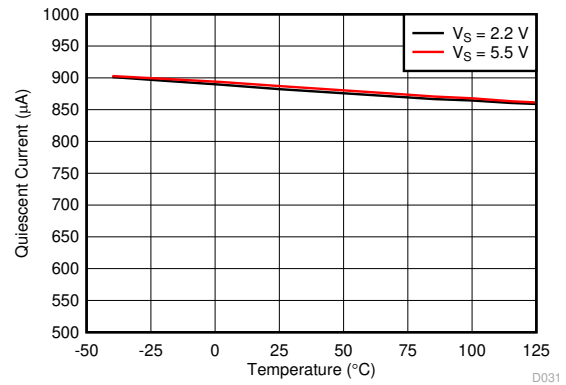

Figure 7-28. Quiescent Current vs Temperature

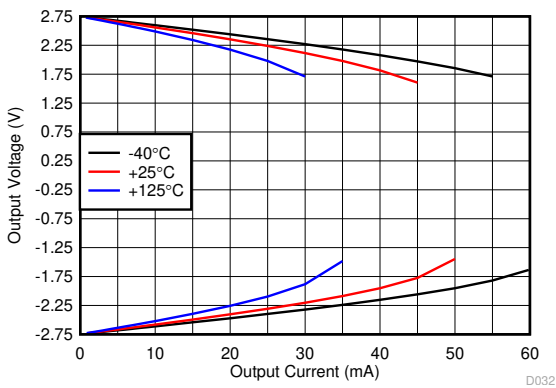

Figure 7-29. Output Voltage vs Output Current Sourcing and Sinking

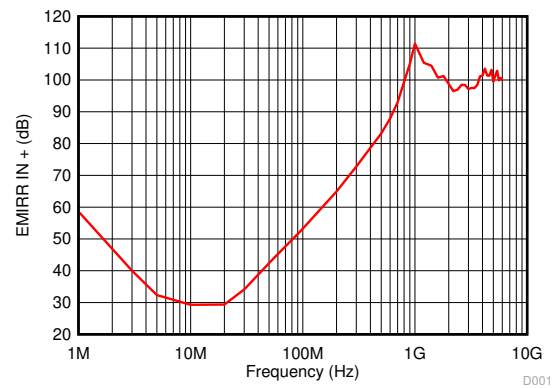

Figure 7-30. Electromagnetic Interference Rejection Ratio Referred to Noninverting Input (EMIRR+) vs Frequency

7.6 Typical Characteristics (continued)

At $T_A = +25^\circ\text{C}$, $V_S = 5.5\text{ V}$, $R_L = 10\text{ k}\Omega$, $R_F = 5\text{ k}\Omega$, $C_F = 2.5\text{ pF}$, $V_{CM} = \text{midsupply} - 0.5\text{ V}$, $G = 6\text{ V/V}$ (unless otherwise noted).

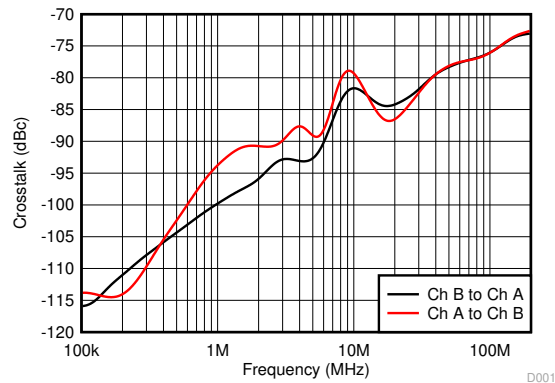

Figure 7-31. Crosstalk vs Frequency

8 Detailed Description

8.1 Overview

The OPAx607-Q1 devices are low-noise, rail-to-rail output (RRO) operational amplifiers (op amp). The devices operate from a supply voltage of 2.2 V to 5.5 V. The input common-mode voltage range also extends down to the negative rail allowing the OPAx607-Q1 to be used in most single-supply applications. Rail-to-rail output swing significantly increases dynamic range, especially in low-supply, voltage-range applications, which results in complete usage of the full-scale range of the consecutive analog-to-digital converters (ADCs). The decompensated architecture allows for a favorable tradeoff of low-quiescent current for a very-high gain-bandwidth product (GBW) and low-distortion performance in high-gain applications.

8.2 Functional Block Diagram

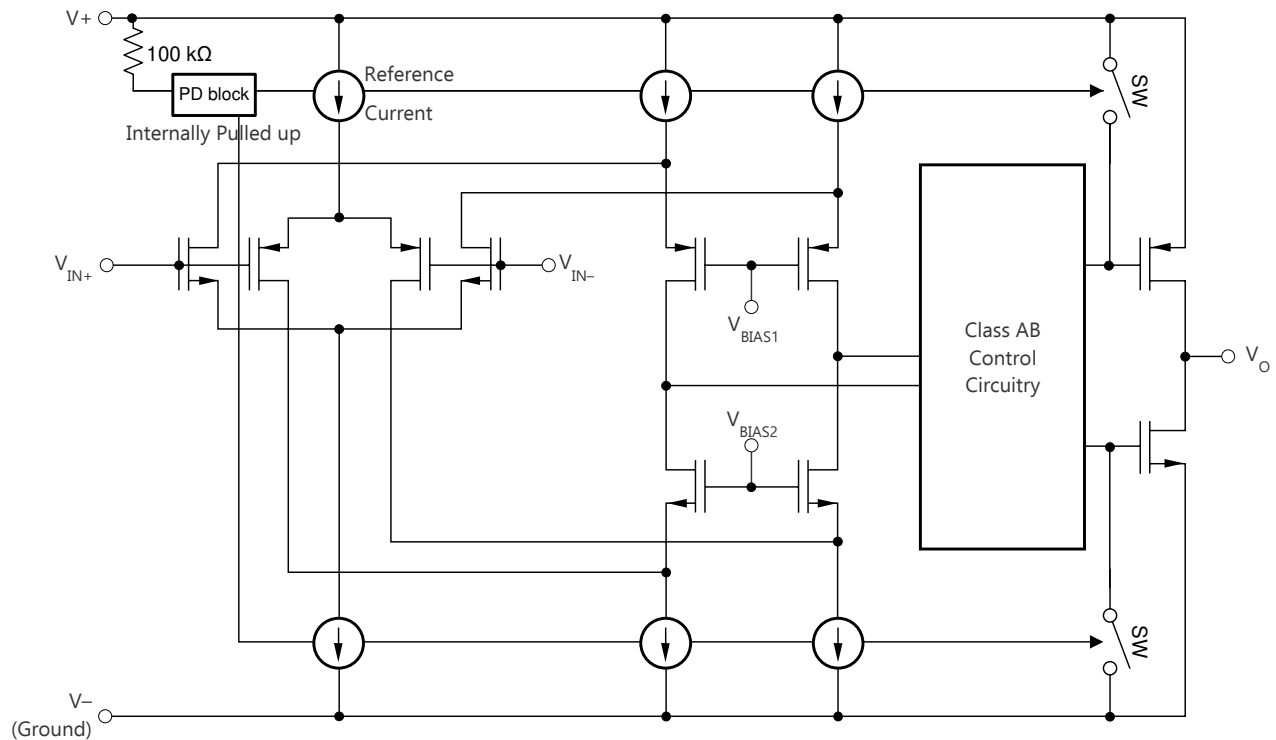

8.3 Feature Description

8.3.1 Operating Voltage

The OPAx607-Q1 operational amplifiers are fully specified and assured for operation from 2.2 V to 5.5 V, applicable from -40°C to $+125^{\circ}\text{C}$. The OPAx607-Q1 devices are completely operational with asymmetric, symmetric and single supply voltages applied across the supply pins. The total voltage (that is, $(V_{S+}) - (V_{S-})$) must be less than the supply voltage mentioned in [Section 7.1](#).

8.3.2 Rail-to-Rail Output and Driving Capacitive Loads

Designed as a low-power, low-voltage operational amplifier, the OPAx607-Q1 devices are capable of delivering a robust output drive. For resistive loads of 10 k Ω , the output swings to within a few millivolts of either supply rail, regardless of the applied power-supply voltage. Different load conditions change the ability of the amplifier to swing close to the rails. The OPAx607-Q1 devices drive up to a nominal capacitive load of 47 pF on the output with no special consideration and without the need of a series isolation resistor R_{ISO} while still being able to achieve 45° of phase margin. When driving capacitive loads greater than 47 pF, TI recommends using R_{ISO} as shown in [Figure 8-1](#) in series with the output as close to the device as possible. Refer to [Recommended Isolation Resistor vs Capacitive Load](#) for looking up different values of R_{ISO} required for C_L to achieve 45° phase margin. Without R_{ISO} , the external capacitance (C_L) interacts with the output impedance (Z_O) of the amplifier, resulting in stability issues. Inserting R_{ISO} isolates C_L from Z_O and restores the phase margin. [Figure 8-1](#) shows the test circuit.

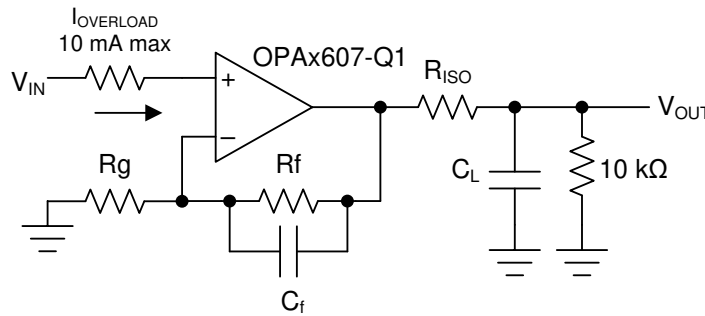
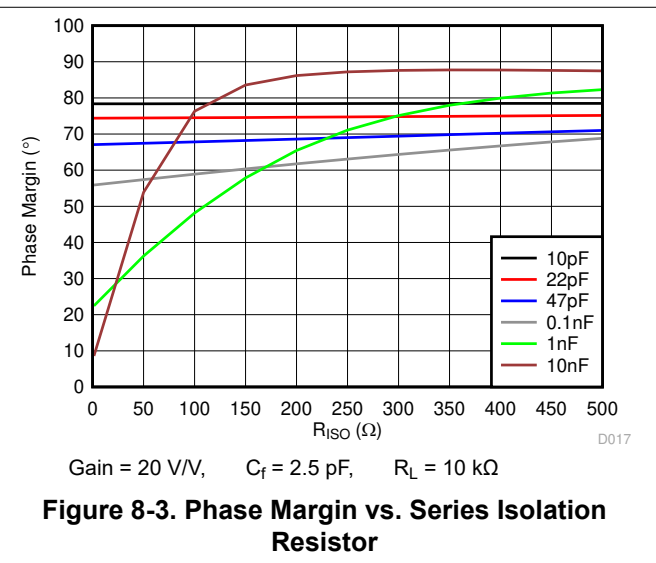
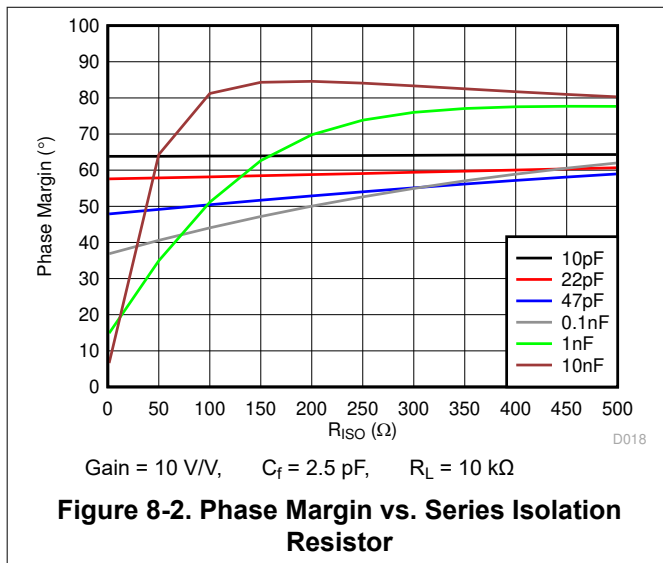

Figure 8-1. Input Current Protection and Driving Capacitive Loads

[Phase Margin vs. Series Isolation Resistor](#) and [Phase Margin vs. Series Isolation Resistor](#) show the phase margin achieved with varying R_{ISO} with different values of C_L .



8.3.3 Input and ESD Protection

When the primary design goal is a linear amplifier with high CMRR, do not exceed the op amp input common-mode voltage range (V_{CM}). This CMRR is used to set the common-mode input range specifications in [Section 7.1](#). The typical V_{CM} specifications for the OPAx607-Q1 devices are from the negative rail to 1.1 V below the positive rail. Assuming the op amp is in linear operation, the voltage difference between the input pins is small (ideally 0 V) and the input common-mode voltage can be analyzed at either input pin; the other input pin is assumed to be at the same potential. The voltage at V_{IN+} is easy to evaluate. In a noninverting configuration ([Figure 8-1](#)) the input signal, V_{IN+} , must not exceed the V_{CM} rating. However, in an inverting amplifier configuration, V_{IN+} must be connected to the voltage within V_{CM} . The input signal applied at V_{IN-} can be any voltage, such that the output voltage swings with a headroom of 10 mV from either of the supply rails.

The input voltage limits have fixed headroom to the power rails and track the power-supply voltages. For single 5-V supply, the linear input voltage range is 0 V to 3.9 V and with a 2.2-V supply this range is 0 V to 1.1 V. The headroom to each power-supply rail is the same in either case: 0 V and 1.1 V. A weak NMOS input pair from V_{IN+} to $V_{IN+} - 1.1$ V ensures that an output phase reversal issue does not occur when the V_{CM} is violated.

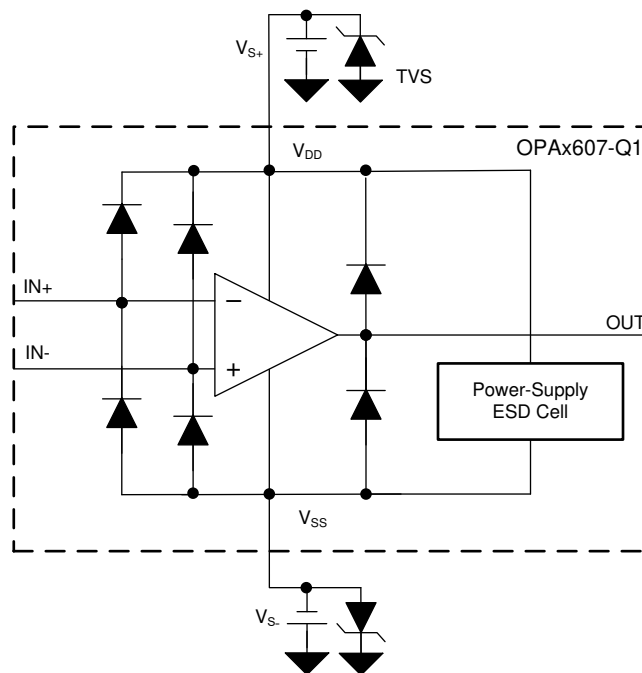

Figure 8-4. Internal ESD Structure

The OPAx607-Q1 devices also incorporate internal electrostatic discharge (ESD) protection circuits on all pins. For the input and output pins, this protection primarily consists of current-steering diodes connected between the input and power-supply pins. These ESD protection diodes provides input overdrive protection, as long as the current is limited with a series resistor to 10 mA, as stated in [Section 7.1](#). [Figure 8-1](#) shows a series input resistor can be added to the driven input to limit the input current.

8.3.4 Decompensated Architecture with Wide Gain-Bandwidth Product

Amplifiers such as the OPAX607-Q1 devices are not unity-gain stable are referred to as *decompensated amplifiers*. The decompensated architecture typically allows for higher GBW, higher slew rate, and lower noise compared to a unity-gain stable amplifier with similar quiescent currents. The increased available bandwidth reduces the rise time and the settling time of the op amp, allowing for sampling at faster rates in an ADC-based signal chain.

As shown in [Figure 8-5](#), the dominant pole f_d is moved to the frequency f_1 in the case of a decompensated op amp. The solid A_{OL} plot is the open-loop gain plot of a traditional unity-gain stable op amp. The change in internal compensation in a decompensated amp such as the OPAX607-Q1, increase the bandwidth for the same amount of power. That is, the decompensated op amp has an increased bandwidth to power ratio when compared to a unity-gain stable op amp of equivalent architecture. Besides the advantages in the above mentioned parameters, an increased slew rate and a better distortion (HD2 and HD3) value is achieved because of the higher available loop-gain, compared to its unity-gain counterpart. The most important factor to consider is ensuring that the op amp is in a noise gain (NG) greater than G_{min} . A value of NG lower than G_{min} results in instability, as shown in [Figure 8-5](#), because the $1/\beta$ curve intersects the A_{OL} curve at 40 dB/decade. This method of analyzing stability is called the *rate of closure method*. See the [precision lab training videos](#) from TI for a better understanding on device stability and for different techniques of ensuring stability.

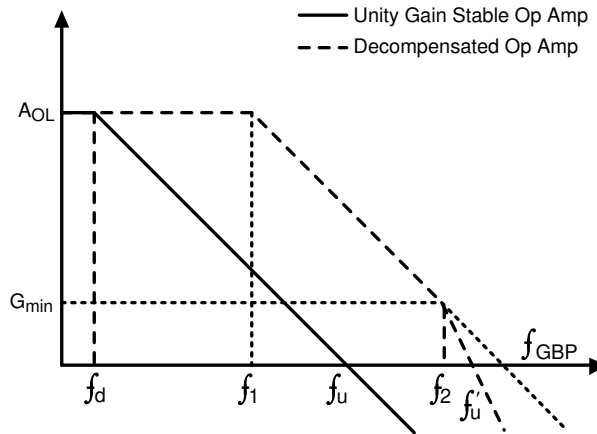

Figure 8-5. Gain vs Frequency Characteristics for a Unity-Gain Stable Op Amp and a Decompensated Op Amp

The OPAX607-Q1 devices are stable in a noise gain of 6 V/V (15.56 dB) or higher in conventional gain circuits; see [Figure 8-6](#). The device has 9 MHz of small-signal bandwidth (SSBW) in this gain configuration with approximately 65° of phase margin. The high GBW and low voltage noise of the OPAX607-Q1 devices make them suitable for general-purpose, high-gain applications.

8.4 Device Functional Modes

The Automotive grade of the OPAx607-Q1 family has only one functional modes: normal operating mode. The PD mode exists only in some of the packages made available in the industrial grade of the OPAx607-Q1 family.

8.4.1 Normal Operating Mode

The OPAx607-Q1 devices are operational when the power-supply voltage is between 2.2 V (± 1.1 V) and 5.5 V (± 2.75 V). Most newer systems use a single power supply to improve efficiency and simplify the power tree design. The OPAx607-Q1 devices can be used with a single-supply power (V_{S-} connected to GND) with no change in performance from split supply, as long as the input and output pins are biased within the linear operating region of the device. The valid input and output voltage ranges are given in [Section 7.5](#). The outputs nominally swing rail-to-rail with approximately 10-mV headroom required for linear operation. The inputs can typically swing up to the negative rail (typically ground) and to within 1.1 V from the positive supply. [Figure 8-6](#) shows changing from a ± 2.5 -V split supply to a 5-V single-supply.

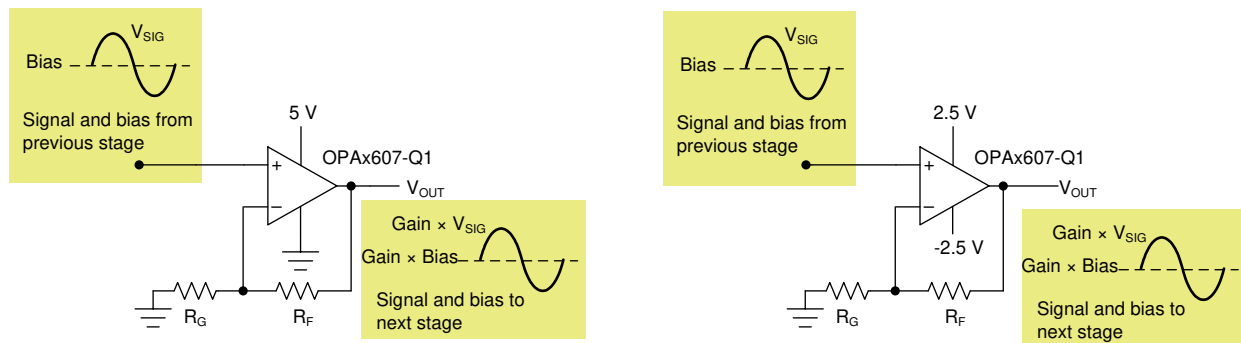

Figure 8-6. Single-Supply and Dual-Supply Operation

9 Application and Implementation

Note

Information in the following applications sections is not part of the TI component specification, and TI does not warrant its accuracy or completeness. TI's customers are responsible for determining suitability of components for their purposes. Customers should validate and test their design implementation to confirm system functionality.

9.1 Application Information

The OPAx607-Q1 devices feature a 50-MHz GBW with 900 μA of supply current, providing good AC performance at low-power consumption. The low input noise voltage of $3.8 \text{ nV}/\sqrt{\text{Hz}}$, the approximate pA of bias current, and a typical input offset voltage of 0.1 mV make the device very suitable for both AC and DC applications.

9.2 Typical Applications

9.2.1 100-k Ω Gain Transimpedance Design

The high GBW and low input voltage and current noise for the OPAx607-Q1 devices make it an excellent wideband transimpedance amplifier for moderate to high transimpedance gains.

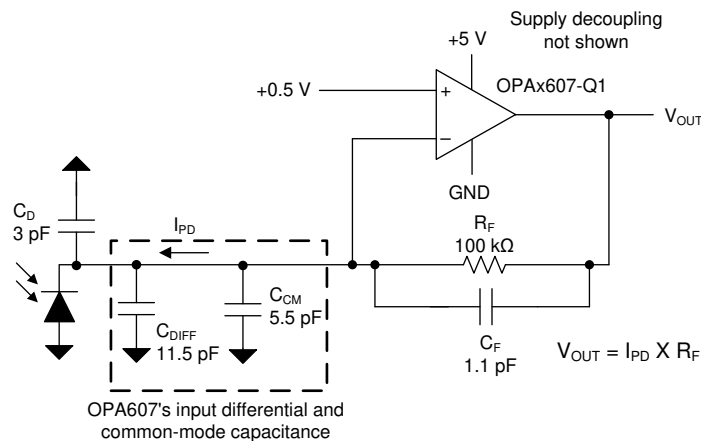

Figure 9-1. Wideband, High-Sensitivity, Transimpedance Amplifier

9.2.1.1 Design Requirements

Design a high-bandwidth, high-transimpedance-gain amplifier with the design requirements shown in [Table 9-1](#).

Table 9-1. Design Requirements

TARGET BANDWIDTH (MHz)	TRANSIMPEDANCE-GAIN (k Ω)	PHOTODIODE CAPACITANCE (pF)
2	100	3

9.2.1.2 Detailed Design Procedure

Designs that require high bandwidth from a large area detector with relatively high transimpedance-gain benefit from the low input voltage noise of the OPAX607-Q1 devices. Use the Excel™ calculator available at [What You Need To Know About Transimpedance Amplifiers – Part 1](#) to help with the component selection based on total input capacitance and C_{TOT}. C_{TOT} is referred as C_{IN} in the calculator. C_{TOT} is the sum of C_D, C_{DIFF}, and C_{CM} which is 20 pF. Using this value of C_{TOT}, and the targeted closed-loop bandwidth (f_{-3dB}) of 2 MHz and transimpedance gain of 100 kΩ results in amplifier GBW of approximately 50 MHz and a feedback capacitance (C_F) of 1.1 pF as shown in Figure 9-2. These results are for a Butterworth response with a Q = 0.707 and a phase margin of approximately 65° which corresponds to 4.3% overshoot.

<i>Calculator II</i>		
Closed-loop TIA Bandwidth (f _{-3dB})	2.00	<i>MHz</i>
Feedback Resistance (R _F)	100.00	<i>kOhm</i>
Input Capacitance (C _{IN})	20.00	<i>pF</i>
Opamp Gain Bandwidth Product (GBP)	50.27	<i>MHz</i>
Feedback Capacitance (C _F)	1.110	<i>pF</i>

Figure 9-2. Results of Inputting Design Parameters in the TIA Calculator

The OPA607-Q1's 50 MHz GBW, is suitable for the above design requirements. If the required feedback capacitance C_F comes out to be a very low value capacitor to be practically achievable, a T-Network capacitor circuit as shown below can be used. A very low capacitor value (C_{EQ}) can be achieved between Port₁ and Port₂ using standard value capacitors in a T-Network circuit as shown in Figure 9-3.

$$C_{EQ} = \frac{C_1 \times C_2}{C_1 + C_2 + C_T} \quad (1)$$

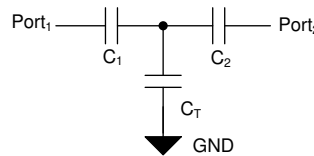
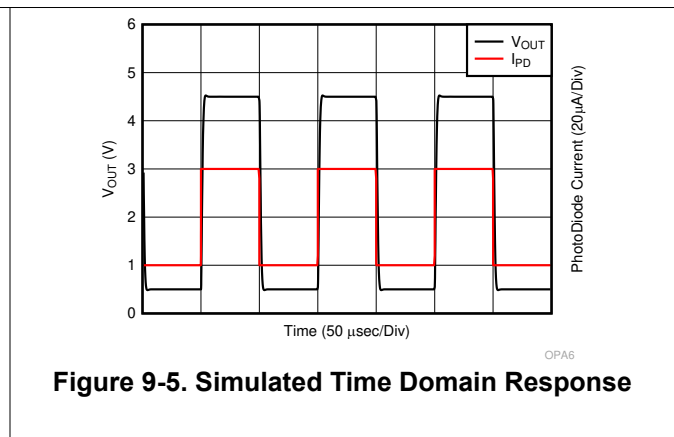
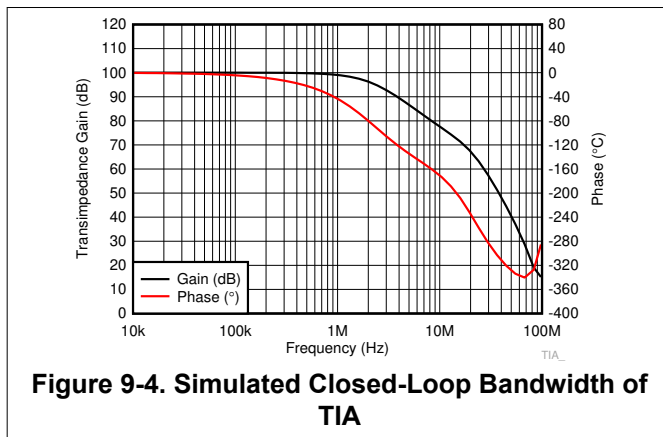

Figure 9-3. T-Network

9.2.1.3 Application Curves



9.2.2 Noninverting Gain of 3 V/V

The OPAx607-Q1 devices are normally stable in noise gain configurations (see [SBOA066](#)) of greater than 6 V/V when conventional feedback networks are used, which is discussed in [Section 8.3.4](#). The OPAx607-Q1 devices can be configured in noise gains of less than 6 V/V by using capacitors in the feedback path and between the inputs to maintain the desired gain at lower frequencies and increase the gain greater than 6 V/V at higher frequencies such that the amplifier is stable. Configuration (a) in [Figure 9-6](#) shows OPAx607-Q1 devices configured in a gain of 3 V/V by using capacitors and resistors to shape the noise gain and achieve a phase margin of approximately 56° that is very close to the phase margin achieved for the conventional 6 V/V configuration (b) in [Figure 9-6](#).

The key benefit of using a decompensated amplifier (such as the OPAx607-Q1) below the minimum stable gain, is that it takes advantage of the low noise and low distortion performance at quiescent powers smaller than comparable unity-gain stable architectures. By reducing the 100-pF input capacitor, higher closed-loop bandwidth can be achieved at the expense of increased peaking and reduced phase margin. Ensure that low parasitic capacitance layout techniques on the IN– pin are as small as 1 pF to 2 pF of parasitic capacitance on the inverting input, which will require tweaking the noise-shaping component values to get a flat frequency response and the desired phase margin. Configurations in [Figure 9-6](#) does not take into account this parasitic capacitance but it must be considered for practical purposes. Details on the benefits of decompensated architectures are discussed in [Using a decompensated op amp for improved performance](#). The *one-capacitor, externally compensated* type method is used for noise gain shaping in the below circuit.

In a difference amplifier circuit, typically used for low side current sensing applications, the (noise gain) = (signal gain + 1).

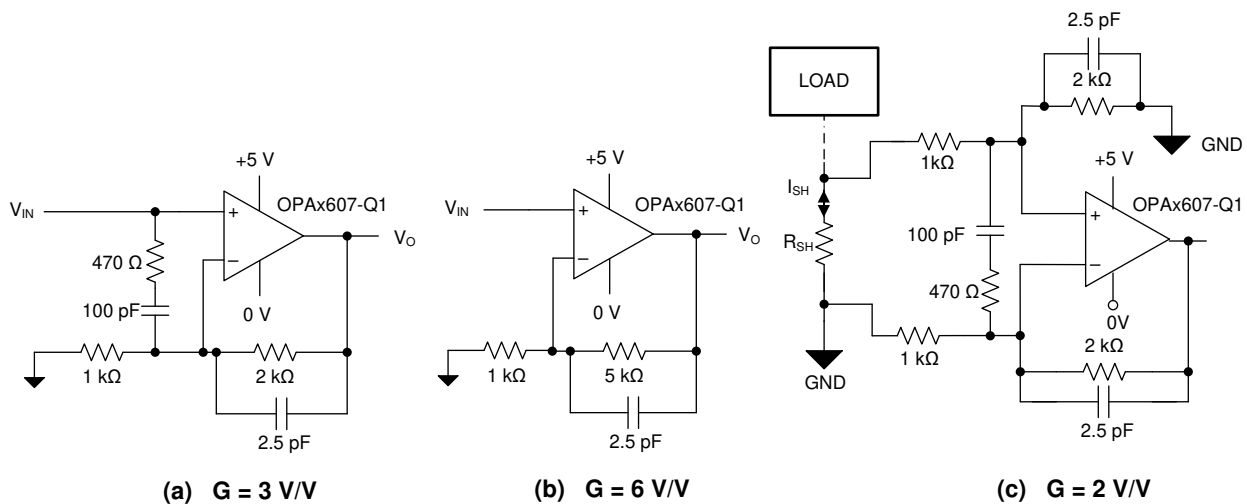

Figure 9-6. Noninverting Gain of 3 V/V, 6 V/V Configurations, and Difference Amplifier in Signal Gain of 2 V/V

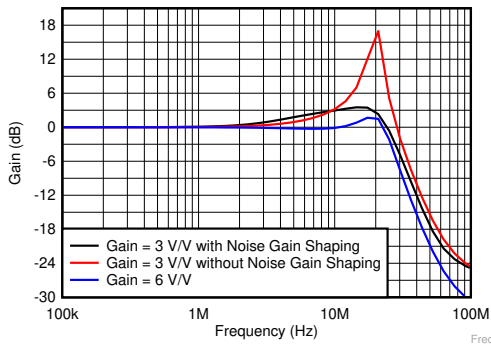

Figure 9-7. Small-Signal Frequency Response in Gains of 3V/V (a) and 6V/V (b)

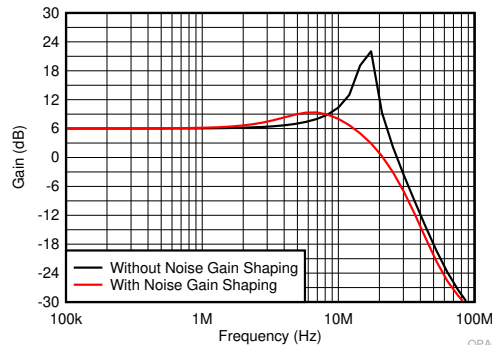

Figure 9-8. Small-Signal Frequency Response of Difference Amplifier (c) With and Without Noise Gain Shaping

9.2.3 High-Input Impedance (Hi-Z), High-Gain Signal Front-End

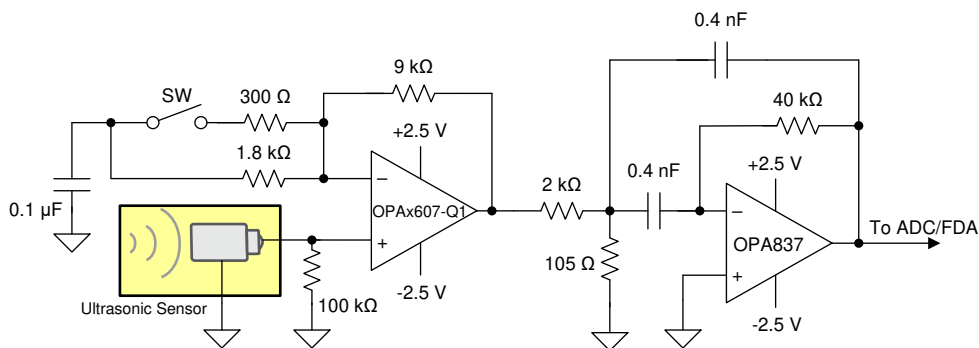

Figure 9-9. Hi-Z, High-Gain Front-End Circuit

9.2.3.1 Design Requirements

The objective is to design a high-input impedance, high-dynamic range, signal-conditioning front-end. An example application for such a front-end circuit is the receive signal chain in an ultrasonic-based end equipment (EE) such as fish finders, printers and flow meters. Table 9-2 lists the design requirements for this application.

Table 9-2. Design Parameters

PARAMETER	DESIGN REQUIREMENT
Amplifier supply	±2.5 V
Input signal frequency	200 kHz
Minimum voltage	300 μVrms
Minimum SNR at 300 μVrms	40 dB

9.2.3.2 Detailed Design Procedure

To achieve a SNR of greater than 40 dB for signals from 300 μ Vrms to 30 mV the front-end stage has two gain settings: 6 V/V and 31 V/V. The SW (switch, relay, or analog mux) can be dynamically toggled to ensure maximum sensitivity to the receiving signal. The OPAX607-Q1 devices prove to be an attractive solution for this front-end signal chain because of the right balance of low noise and high input impedance. The ultrasonic sensors (for example, piezo crystal) have high output impedance. The OPAX607-Q1 devices have an input bias current of 20 pA (maximum). This small bias current results in reduced distortion and signal loss across the source impedance when compared with a bipolar amplifier with input bias currents in the range of a few hundreds of nano-amperes. The OPAX607-Q1's high-gain front-end is followed by a narrowband band-pass filter that is tuned to a 200-kHz center frequency. The narrowband filter is designed using the OPA837. OPA837 can be used as a variable gain mux / PGA as shown in TIDA-01565. In this application section the OPA837-based band-pass filter was designed using the techniques mentioned in the [Filter Design in Thirty Seconds application report](#).

Figure 9-11 shows the frequency response of circuit in Figure 9-9. As shown in Figure 9-11, the frequency response is a high-Q factor band-pass filter centered around 200 kHz. Designing such a high-Q band-pass filter helps eliminate white band noise along with other interferences present in the circuitry, resulting in a high SNR signal chain. The OPAX607-Q1's front-end combined with the OPA837-based band-pass filter help to achieve a total gain of 33 dB (44 V/V) or 50 dB (316 V/V) based on the SW (switch) position.

9.2.3.3 Application Curves

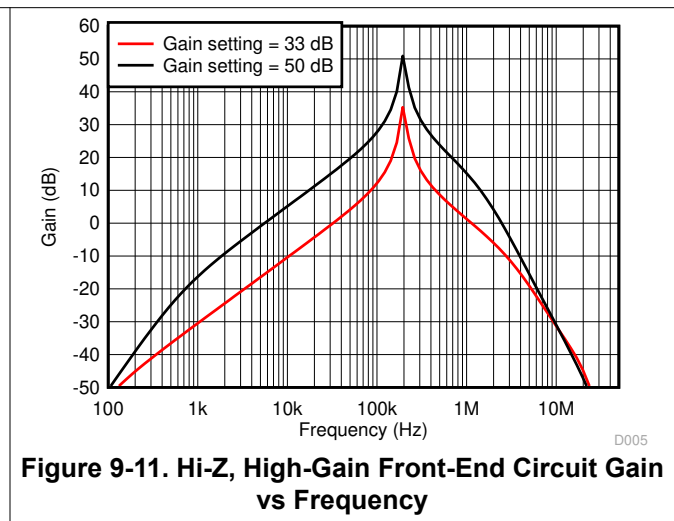
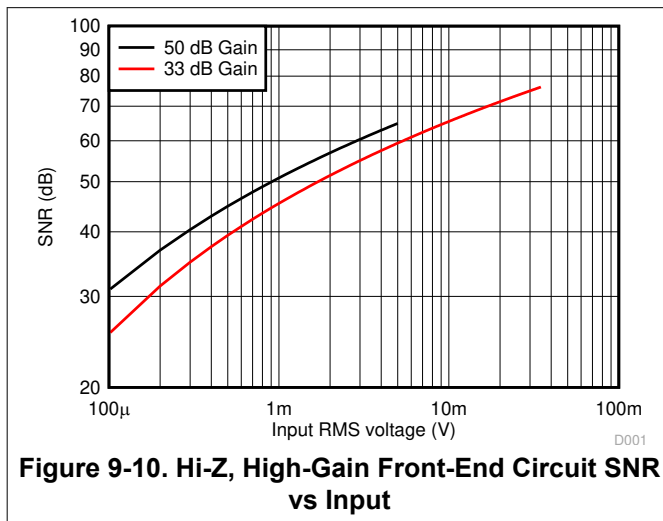

9.2.4 Low-Cost, Low Side, High-Speed Current Sensing

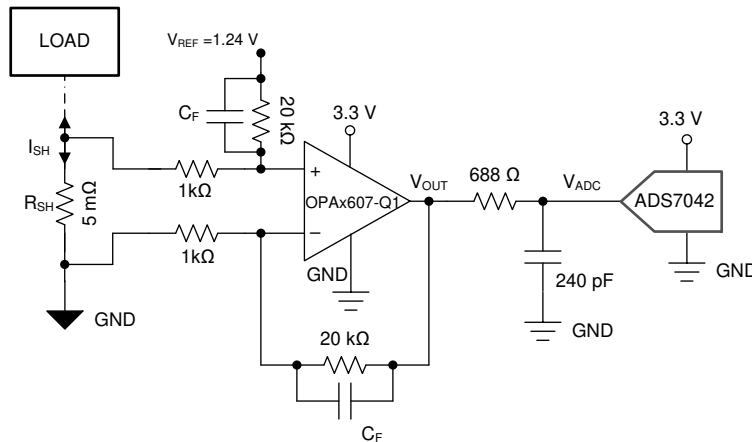

Figure 9-12. Low Side Current Sensing

9.2.4.1 Design Requirements

The objective is to design a high-speed, high-gain bidirectional current-sensing circuit for power systems and motor drive systems. Section 9.2.4.2 lists the design requirements of this application.

Table 9-3. Design Parameters

PARAMETER	DESIGN REQUIREMENT
Amplifier and ADC supply	3.3 V
Peak current to be measured from load to ground	20 A
Peak current to be measured from ground to load	12 A
Required Accuracy of current measurement	0.1%
Signal-Setting time at ADC input	< 1 μs
Current sensing direction	Bidirectional

9.2.4.2 Detailed Design Procedure

The aim of this application section is to measure bidirectional current with relatively high accuracy in a low-side-sensing-based, high-frequency switching system.

As shown in Figure 9-12, a single op amp of high bandwidth is capable of sensing current in a high gain configuration as well as have the required effective bandwidth to drive the consecutive SAR ADC input. The SAR ADC can be a standalone ADC or integrated inside a Micro-controller.

$$V_{OUT} = (20 \text{ k}\Omega / 1 \text{ k}\Omega \times V_{DIFF}) + V_{REF}, \text{ where } V_{DIFF} = I_{SH} \times R_{SH} \quad (2)$$

The reference voltage is 1.24 V. When the I_{SH} flowing across R_{SH} equals zero, the V_{OUT} of the difference amplifier sits ideal at 1.24 V.

When the current (I_{SH}) flows from LOAD to GND, the output of the OPAx607-Q1 increase above 1.24 V with a value equal to $20 \times V_{SH}$ and when the current flows from GND to LOAD (in the opposite direction) the output of the OPAx607-Q1 decrease below 1.24 V with a value proportional to $20 \times V_{SH}$.

One of the main challenges in a high speed current sensing design is to choose an op amp of with sufficient GBW that can drive a SAR ADC, while still being able to gain the signal by the required amount. The 0.1% and 0.01% settling of OPAx607-Q1 can found in Section 7.5. Another key care about is to ensure the op amp output rises in less than 1 μs so as to feed the output to a comparator for short-circuit protection. This comparator based short circuit protection loop is extremely fast and enables to turn off the switching devices very quickly. This requirement makes a low cost high speed part like the OPAx607-Q1 very desirable in a current-sensing circuit. Equation of the rise time as a function of bandwidth is shown below.

$$t_R \text{ (10\% to 90\%)} = 0.35 \text{ Hz / BW} \tag{3}$$

For an ADC like ADS7042 running at a sampling rate of 500 kSPS of a clock of 12.5 MHz, the effective bandwidth of the op amp required to drive such an ADC is approximately 2.7 MHz. See the [TI precision lab](#) videos on driving SAR ADCs to understand the underlying calculation. The OPAx607-Q1 has a GBW of 50 MHz. With a gain of 20 V/V, the closed loop bandwidth turns out to approximately 2.5 MHz, making this device the most suitable, cost-optimized amplifier for this application. The RC charge bucket (240 Ω and 688 pF in [Figure 9-12](#)) designed at the input of the SAR ADC is derived from the calculations provided in the SAR ADC precision lab videos. The fundamental concept behind the design of this charge bucket filter is to ensure that the sample and hold capacitor is charged to the required final voltage within the acquisition window of the ADC.

As shown in [Figure 9-14](#), a DC accuracy of higher than 0.05% is achieved with the OPAx607-Q1. The simulations are captured with and without voltage offset calibration. Frequency response shown in [Figure 9-13](#) indicate different signal bandwidth at V_{OUT} , V_{ADC} and with and without C_F of 220 pF.

9.2.4.3 Application Curves

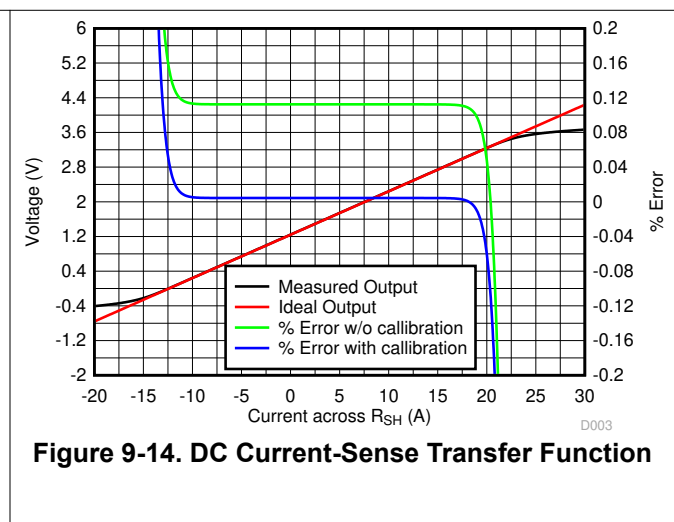
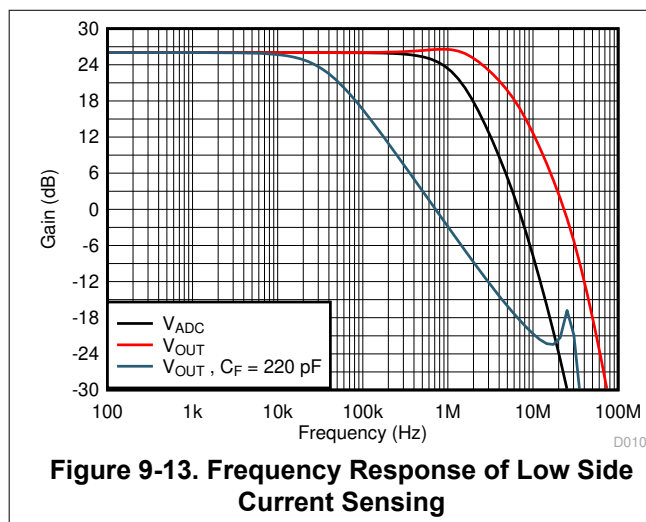

10 Power Supply Recommendations

The OPAx607-Q1 devices are specified for operation from 2.2 V to 5.5 V (± 1.1 V to ± 2.75 V), applicable from -40°C to $+125^\circ\text{C}$. Place 0.1- μF bypass capacitors close to the power-supply pins to reduce errors coupling in from noisy or high-impedance power supplies.

CAUTION
Supply voltages larger than 6 V can permanently damage the device (see [Section 7.1](#)).

For more detailed information on bypass capacitor placement, see [Section 11.1](#).

11 Layout

11.1 Layout Guidelines

For best operational performance of the device, use good printed circuit board (PCB) layout practices, including:

- Noise can propagate into analog circuitry through the power-supply pins of the circuit as a whole and of the operational amplifier. Bypass capacitors are used to reduce the coupled noise by providing low-impedance power sources local to the analog circuitry.
 - Connect low-equivalent series resistance (ESR), 0.1- μ F ceramic bypass capacitors between each supply pin and ground, placed as close to the device as possible. A single bypass capacitor from V+ to ground is applicable for single-supply applications.
- Separate grounding for analog and digital portions of the circuitry is one of the simplest and most effective methods of noise suppression. One or more layers on multilayer PCBs are usually devoted to ground planes. A ground plane helps distribute heat and reduces electromagnetic interference (EMI) noise pickup. Make sure to physically separate digital and analog grounds, paying attention to the flow of the ground current.
- To reduce parasitic coupling, run the input traces as far away from the supply or output traces as possible. If these traces cannot be kept separate, crossing the sensitive trace perpendicularly is much better than crossing in parallel with the noisy trace.
- Place the external components as close to the device as possible. Keeping R_F and R_G close to the inverting input minimizes parasitic capacitance; see [Figure 11-1](#) and [Figure 11-2](#).
- Keep the length of input traces as short as possible. Always remember that the input traces are the most sensitive part of the circuit.
- Consider a driven, low-impedance guard ring around the critical traces. A guard ring can significantly reduce leakage currents from nearby traces that are at different potentials.

11.2 Layout Examples

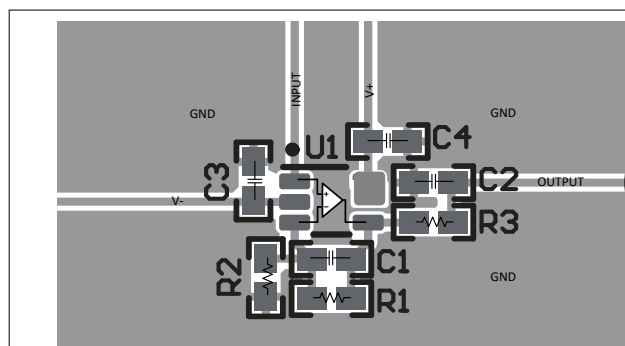

Figure 11-1. Operational Amplifier Board Layout for a Noninverting Configuration

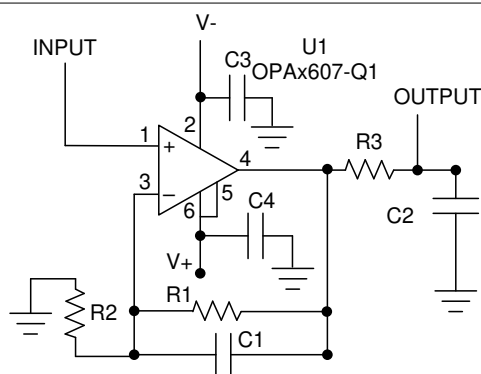

Figure 11-2. Layout Example Schematic

12 Device and Documentation Support

12.1 Device Support

12.1.1 Development Support

- Texas Instruments, [precision lab videos](#)

12.2 Documentation Support

12.2.1 Related Documentation

For related documentation see the following:

- Texas Instruments, [ADS7042 Ultra-Low Power, Ultra-Small Size, 12-Bit, 1-MSPS, SAR ADC data sheet](#)
- Texas Instruments, [Filter Design in Thirty Seconds application report](#)
- Texas Instruments, [OPA2834 50-MHz, 170- \$\mu\$ A, Negative-Rail In, Rail-to-Rail Out, Voltage-Feedback Amplifier data sheet](#)
- Texas Instruments, [OPAx836 Very-Low-Power, Rail-to-Rail Out, Negative Rail In, Voltage-Feedback Operational Amplifiers data sheet](#)
- Texas Instruments, [Ultrasonic Sensing Subsystem Reference Design For Gas Flow Measurement design guide](#)

12.3 Receiving Notification of Documentation Updates

To receive notification of documentation updates, navigate to the device product folder on ti.com. In the upper right corner, click on *Alert me* to register and receive a weekly digest of any product information that has changed. For change details, review the revision history included in any revised document.

12.4 Support Resources

[TI E2E™ support forums](#) are an engineer's go-to source for fast, verified answers and design help — straight from the experts. Search existing answers or ask your own question to get the quick design help you need.

Linked content is provided "AS IS" by the respective contributors. They do not constitute TI specifications and do not necessarily reflect TI's views; see TI's [Terms of Use](#).

12.5 Trademarks

Excel™ is a trademark of Microsoft Corporation.

TI E2E™ is a trademark of Texas Instruments.

All trademarks are the property of their respective owners.

12.6 Electrostatic Discharge Caution



This integrated circuit can be damaged by ESD. Texas Instruments recommends that all integrated circuits be handled with appropriate precautions. Failure to observe proper handling and installation procedures can cause damage.

ESD damage can range from subtle performance degradation to complete device failure. Precision integrated circuits may be more susceptible to damage because very small parametric changes could cause the device not to meet its published specifications.

12.7 Glossary

[TI Glossary](#) This glossary lists and explains terms, acronyms, and definitions.

13 Mechanical, Packaging, and Orderable Information

The following pages include mechanical, packaging, and orderable information. This information is the most current data available for the designated devices. This data is subject to change without notice and revision of this document. For browser-based versions of this data sheet, refer to the left-hand navigation.

PACKAGING INFORMATION

Orderable Device	Status (1)	Package Type	Package Drawing	Pins	Package Qty	Eco Plan (2)	Lead finish/ Ball material (6)	MSL Peak Temp (3)	Op Temp (°C)	Device Marking (4/5)	Samples
OPA2607QDGKRQ1	ACTIVE	VSSOP	DGK	8	2500	RoHS & Green	NIPDAU	Level-1-260C-UNLIM	-40 to 125	2FST	Samples
OPA607QDBVRQ1	ACTIVE	SOT-23	DBV	5	3000	RoHS & Green	NIPDAU	Level-1-260C-UNLIM	-40 to 125	6QBV	Samples

(1) The marketing status values are defined as follows:

ACTIVE: Product device recommended for new designs.

LIFEBUY: TI has announced that the device will be discontinued, and a lifetime-buy period is in effect.

NRND: Not recommended for new designs. Device is in production to support existing customers, but TI does not recommend using this part in a new design.

PREVIEW: Device has been announced but is not in production. Samples may or may not be available.

OBSOLETE: TI has discontinued the production of the device.

(2) **RoHS:** TI defines "RoHS" to mean semiconductor products that are compliant with the current EU RoHS requirements for all 10 RoHS substances, including the requirement that RoHS substance do not exceed 0.1% by weight in homogeneous materials. Where designed to be soldered at high temperatures, "RoHS" products are suitable for use in specified lead-free processes. TI may reference these types of products as "Pb-Free".

RoHS Exempt: TI defines "RoHS Exempt" to mean products that contain lead but are compliant with EU RoHS pursuant to a specific EU RoHS exemption.

Green: TI defines "Green" to mean the content of Chlorine (Cl) and Bromine (Br) based flame retardants meet JS709B low halogen requirements of <=1000ppm threshold. Antimony trioxide based flame retardants must also meet the <=1000ppm threshold requirement.

(3) MSL, Peak Temp. - The Moisture Sensitivity Level rating according to the JEDEC industry standard classifications, and peak solder temperature.

(4) There may be additional marking, which relates to the logo, the lot trace code information, or the environmental category on the device.

(5) Multiple Device Markings will be inside parentheses. Only one Device Marking contained in parentheses and separated by a "~" will appear on a device. If a line is indented then it is a continuation of the previous line and the two combined represent the entire Device Marking for that device.

(6) Lead finish/Ball material - Orderable Devices may have multiple material finish options. Finish options are separated by a vertical ruled line. Lead finish/Ball material values may wrap to two lines if the finish value exceeds the maximum column width.

Important Information and Disclaimer:The information provided on this page represents TI's knowledge and belief as of the date that it is provided. TI bases its knowledge and belief on information provided by third parties, and makes no representation or warranty as to the accuracy of such information. Efforts are underway to better integrate information from third parties. TI has taken and continues to take reasonable steps to provide representative and accurate information but may not have conducted destructive testing or chemical analysis on incoming materials and chemicals. TI and TI suppliers consider certain information to be proprietary, and thus CAS numbers and other limited information may not be available for release.

In no event shall TI's liability arising out of such information exceed the total purchase price of the TI part(s) at issue in this document sold by TI to Customer on an annual basis.

OTHER QUALIFIED VERSIONS OF OPA2607-Q1, OPA607-Q1 :

- Catalog : [OPA2607](#), [OPA607](#)

NOTE: Qualified Version Definitions:

- Catalog - TI's standard catalog product

TAPE AND REEL INFORMATION



QUADRANT ASSIGNMENTS FOR PIN 1 ORIENTATION IN TAPE



*All dimensions are nominal

Device	Package Type	Package Drawing	Pins	SPQ	Reel Diameter (mm)	Reel Width W1 (mm)	A0 (mm)	B0 (mm)	K0 (mm)	P1 (mm)	W (mm)	Pin1 Quadrant
OPA2607QDGKRQ1	VSSOP	DGK	8	2500	330.0	12.4	5.3	3.4	1.4	8.0	12.0	Q1
OPA607QDBVRQ1	SOT-23	DBV	5	3000	180.0	8.4	3.2	3.2	1.4	4.0	8.0	Q3
OPA607QDBVRQ1	SOT-23	DBV	5	3000	180.0	8.4	3.2	3.2	1.4	4.0	8.0	Q3

TAPE AND REEL BOX DIMENSIONS



*All dimensions are nominal

Device	Package Type	Package Drawing	Pins	SPQ	Length (mm)	Width (mm)	Height (mm)
OPA2607QDGKRQ1	VSSOP	DGK	8	2500	366.0	364.0	50.0
OPA607QDBVRQ1	SOT-23	DBV	5	3000	210.0	185.0	35.0
OPA607QDBVRQ1	SOT-23	DBV	5	3000	210.0	185.0	35.0

EXAMPLE BOARD LAYOUT

DBV0005A

SOT-23 - 1.45 mm max height

SMALL OUTLINE TRANSISTOR



LAND PATTERN EXAMPLE
EXPOSED METAL SHOWN
SCALE:15X



SOLDER MASK DETAILS

4214839/K 08/2024

NOTES: (continued)

- 6. Publication IPC-7351 may have alternate designs.
- 7. Solder mask tolerances between and around signal pads can vary based on board fabrication site.

EXAMPLE STENCIL DESIGN

DBV0005A

SOT-23 - 1.45 mm max height

SMALL OUTLINE TRANSISTOR



SOLDER PASTE EXAMPLE
BASED ON 0.125 mm THICK STENCIL
SCALE:15X

4214839/K 08/2024

NOTES: (continued)

8. Laser cutting apertures with trapezoidal walls and rounded corners may offer better paste release. IPC-7525 may have alternate design recommendations.
9. Board assembly site may have different recommendations for stencil design.

DGK0008A



PACKAGE OUTLINE

VSSOP - 1.1 mm max height

SMALL OUTLINE PACKAGE



4214862/A 04/2023

NOTES:

PowerPAD is a trademark of Texas Instruments.

1. All linear dimensions are in millimeters. Any dimensions in parenthesis are for reference only. Dimensioning and tolerancing per ASME Y14.5M.
2. This drawing is subject to change without notice.
3. This dimension does not include mold flash, protrusions, or gate burrs. Mold flash, protrusions, or gate burrs shall not exceed 0.15 mm per side.
4. This dimension does not include interlead flash. Interlead flash shall not exceed 0.25 mm per side.
5. Reference JEDEC registration MO-187.

EXAMPLE BOARD LAYOUT

DGK0008A

™ VSSOP - 1.1 mm max height

SMALL OUTLINE PACKAGE



LAND PATTERN EXAMPLE
EXPOSED METAL SHOWN
SCALE: 15X



SOLDER MASK DETAILS

4214862/A 04/2023

NOTES: (continued)

6. Publication IPC-7351 may have alternate designs.
7. Solder mask tolerances between and around signal pads can vary based on board fabrication site.
8. Vias are optional depending on application, refer to device data sheet. If any vias are implemented, refer to their locations shown on this view. It is recommended that vias under paste be filled, plugged or tented.
9. Size of metal pad may vary due to creepage requirement.

EXAMPLE STENCIL DESIGN

DGK0008A

™ VSSOP - 1.1 mm max height

SMALL OUTLINE PACKAGE



SOLDER PASTE EXAMPLE
SCALE: 15X

4214862/A 04/2023

NOTES: (continued)

11. Laser cutting apertures with trapezoidal walls and rounded corners may offer better paste release. IPC-7525 may have alternate design recommendations.
12. Board assembly site may have different recommendations for stencil design.

IMPORTANT NOTICE AND DISCLAIMER

TI PROVIDES TECHNICAL AND RELIABILITY DATA (INCLUDING DATA SHEETS), DESIGN RESOURCES (INCLUDING REFERENCE DESIGNS), APPLICATION OR OTHER DESIGN ADVICE, WEB TOOLS, SAFETY INFORMATION, AND OTHER RESOURCES "AS IS" AND WITH ALL FAULTS, AND DISCLAIMS ALL WARRANTIES, EXPRESS AND IMPLIED, INCLUDING WITHOUT LIMITATION ANY IMPLIED WARRANTIES OF MERCHANTABILITY, FITNESS FOR A PARTICULAR PURPOSE OR NON-INFRINGEMENT OF THIRD PARTY INTELLECTUAL PROPERTY RIGHTS.

These resources are intended for skilled developers designing with TI products. You are solely responsible for (1) selecting the appropriate TI products for your application, (2) designing, validating and testing your application, and (3) ensuring your application meets applicable standards, and any other safety, security, regulatory or other requirements.

These resources are subject to change without notice. TI grants you permission to use these resources only for development of an application that uses the TI products described in the resource. Other reproduction and display of these resources is prohibited. No license is granted to any other TI intellectual property right or to any third party intellectual property right. TI disclaims responsibility for, and you will fully indemnify TI and its representatives against, any claims, damages, costs, losses, and liabilities arising out of your use of these resources.

TI's products are provided subject to [TI's Terms of Sale](#) or other applicable terms available either on [ti.com](https://www.ti.com) or provided in conjunction with such TI products. TI's provision of these resources does not expand or otherwise alter TI's applicable warranties or warranty disclaimers for TI products.

TI objects to and rejects any additional or different terms you may have proposed.

Mailing Address: Texas Instruments, Post Office Box 655303, Dallas, Texas 75265
Copyright © 2024, Texas Instruments Incorporated