

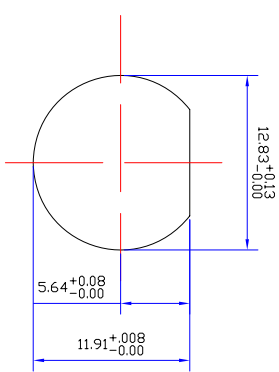

Product NO.		DOSIN-802-0016		
REV	DESCRIPTION	DWN	DATE	APPROVEN
A	First Issue	JJM	2012/11/02	John kine

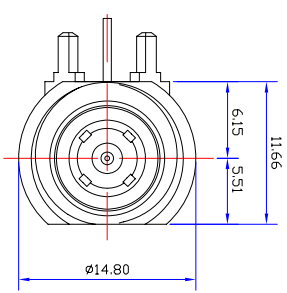
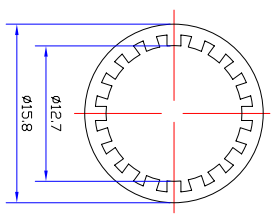
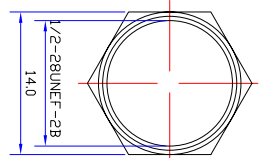
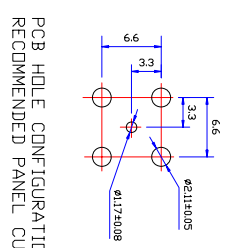
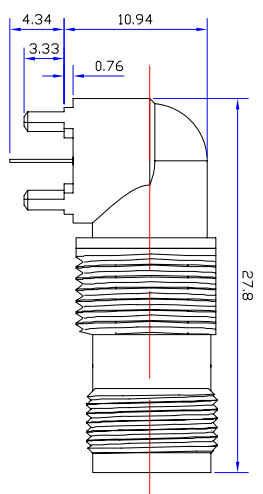
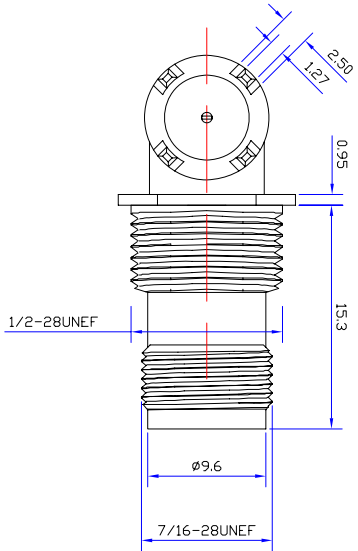

### Specifications

Frequency Range: DC~3G  
 VSWR: 1.3MAX  
 Working Voltage: 500V rms @ sea level  
 Insulation Resistance: 5000 Ohms min  
 Temperature Range: -55°C T0 +155°C  
 Relative Temperature: ≤95% (40°C ±2°C)  
 Drawings products are in line with ROHS standards

NOTE:		Tolerance		0-6 6-30 30-120 Angular		±0.15 ±0.20 ±0.5 ±2°	
DRAWN		Zelin Zhang		2012/11/10		View	
CHECKED						UNIT	
APPROVALS		Date		SCALE		MM	
Yalin Xie		19/04/2012		1:1		MM	
Name:		TNC CONNECTOR DNN		SIZE		Product NO.	
DOSIN Industrial(H.K)Co.Ltd		DOSIN-802-0016		DateTime		CAD FILE	
Doshin Hardware Electronics Co.,Ltd		DOSIN-802-0016		2012/11/02		D/company drawings/BD	
E-mail: dosin2005@163.com		REV		SHEET: 1 OF 1			
dosin2005@doshin-china.com		B					
Web: http://www.doshin.com							
TEL: (0086)769-81153906							
FAX: (0086)769-81875836							

3	BODY	ZINC	NICKEL	1
2	INSULATOR	POM	WHITE	1
1	PIN	BRASS	GOLD	1
NO	DESCRIPTION	MATERIAL	FINISH	QTY