

Product Summary

- V_{DS} 30 V
- I_{DS} 0.8A
- $R_{DS(ON)}$ (at $V_{GS}=4.5V$) $\leq 450m\Omega$
- $R_{DS(ON)}$ (at $V_{GS}=2.5V$) $\leq 650m\Omega$

Application

- Reverse Battery protection
- Load switch
- Power management
- Motor Control

Package and Pin Configuration

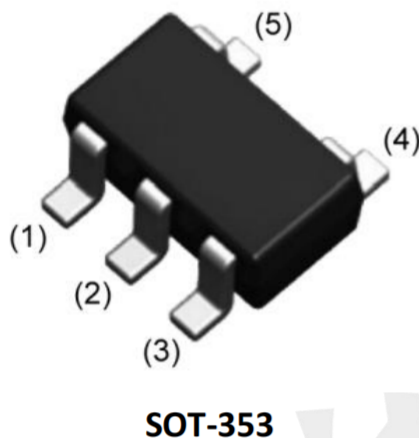

Circuit diagram

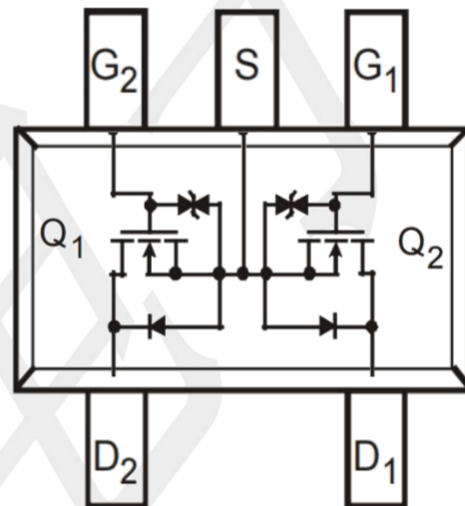

Absolute Maximum Ratings $(T_A=25^\circ C$ unless otherwise noted)

PARAMETER	SYMBOL	LIMIT	UNIT
Drain-Source Voltage	V_{DS}	30	V
Gate-Source Voltage	V_{GS}	± 12	V
Continuous Drain Current	I_D	0.8	A
Total Power Dissipation	P_{DTOT}	0.28	W
Operating Junction Temperature Range	T_J	-55 to +150	$^\circ C$
Storage Temperature Range	T_{stg}	-55 to +150	$^\circ C$

Thermal Characteristic

PARAMETER	Symbol	Value	Unit
Junction-to-Ambient Thermal Resistance	R_{thJA}	446	$^\circ C/W$

PCB Mount (Note)

Note : When mounted on 1" square PCB (FR4 material).

Electrical Characteristics (T_A=25°C unless otherwise noted)

PARAMETER	CONDITIONS	SYMBOL	MIN	TYP	MAX	UNIT
Static						
Drain-Source Breakdown Voltage	V _{GS} =0V, I _D = 250μA	BV _{DSS}	30	--	--	V
Gate-Source Threshold Voltage	V _{DS} =V _{GS} , I _D = 250μA	V _{GS(th)}	0.5	0.8	1.2	V
Gate-Source Leakage	V _{DS} =0V, V _{GS} = ±12V	I _{GSS}	--	--	±20	μA
Zero Gate Voltage Drain Current	V _{DS} = 30V, V _{GS} =0V	I _{DSS}	--	--	1	μA
	V _{DS} = 30V, T _J =125°C		--	--	10	μA
Drain-Source On-State Resistance (Note 1)	V _{GS} = 4.5V, I _D = 0.5A	R _{DS(on)}	--	350	450	mΩ
	V _{GS} = 2.5V, I _D = 0.5A		--	450	650	
Forward Transconductance (Note 2)	V _{DS} = 4V, I _D = 0.3A	g _{fs}	--	1.1	--	S
Dynamic (Note 2)						
Total Gate Charge (Note 3)	V _{DS} = 15V, I _D = 0.3A, V _{GS} = 4.5V	Q _g	--	2.6	--	nC
Gate-Source Charge (Note 3)		Q _{gs}	--	1.0	--	
Gate-Drain Charge (Note 3)		Q _{gd}	--	0.6	--	
Input Capacitance	V _{DS} = 15V, V _{GS} = 0V, F= 1.0MHz	C _{iss}	--	73	--	pF
Output Capacitance		C _{oss}	--	18	--	
Reverse Transfer Capacitance		C _{rss}	--	8.6	--	
Switching						
Turn-On Delay Time (Note 3)	V _{DD} = 15V, I _D = 0.3A, V _{GS} = 4.5V, R _{GEN} = 10Ω	t _{d(on)}	--	5.5	--	nS
Rise Time (Note 3)		t _r	--	4.8	--	
Turn-Off Delay Time (Note 3)		t _{d(off)}	--	15	--	
Fall Time (Note 3)		t _f	--	6.5	--	
Source-Drain Diode Ratings and Characteristics (Note 2)						
Forward Voltage	V _{GS} = 0V, I _F = 0.15A	V _{SD}	--	0.8	1.2	V

Notes:

1. Pulse test; pulse width ≤ 300 μs, duty cycle ≤ 2%.
2. Guaranteed by design, not subject to production testing.
3. Independent of operating temperature

TYPICAL CHARACTERISTICS

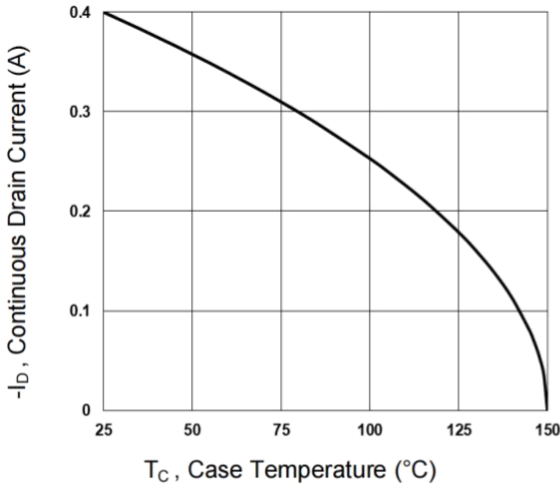

Figure 1. Continuous Drain Current vs. T_C

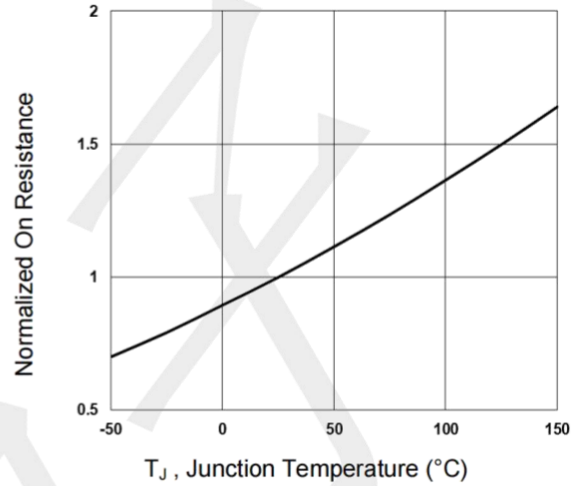

Figure 2. Normalized $R_{DS(on)}$ vs. T_J

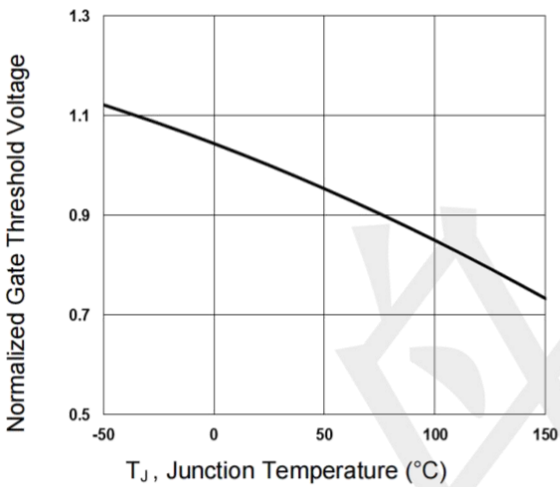

Figure 3. Normalized V_{th} vs. T_J

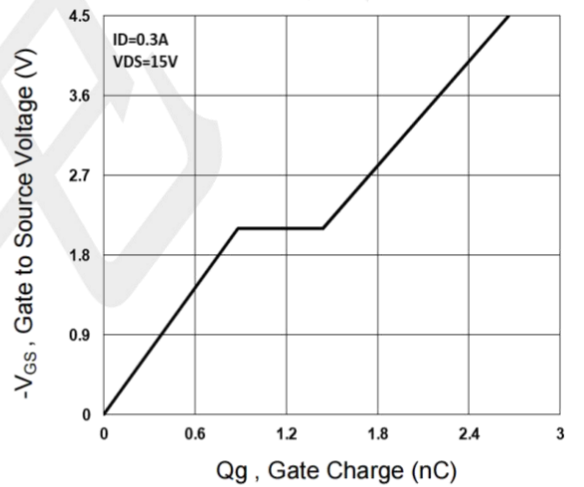

Figure 4. Gate Charge Waveform

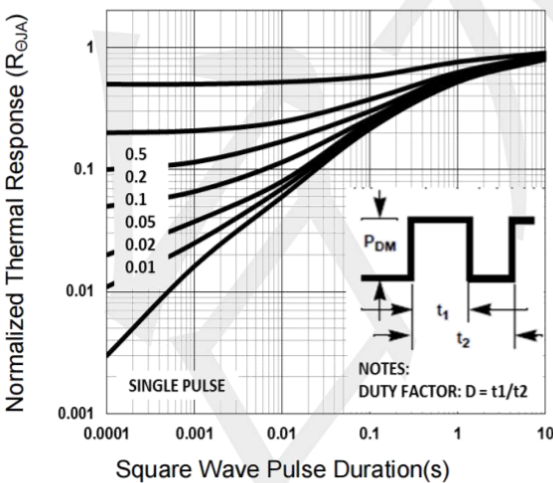

Figure 5. Normalized Transient Response

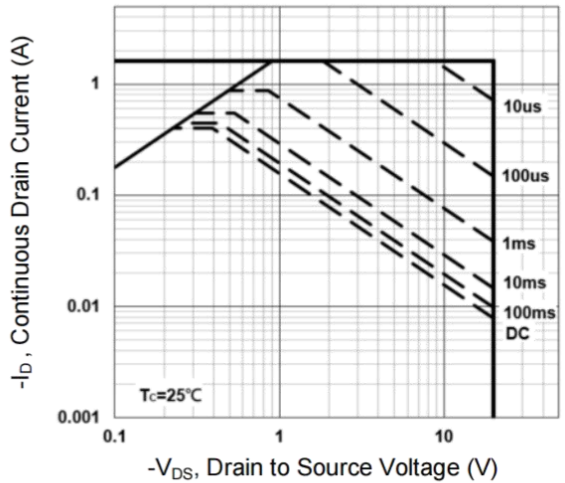
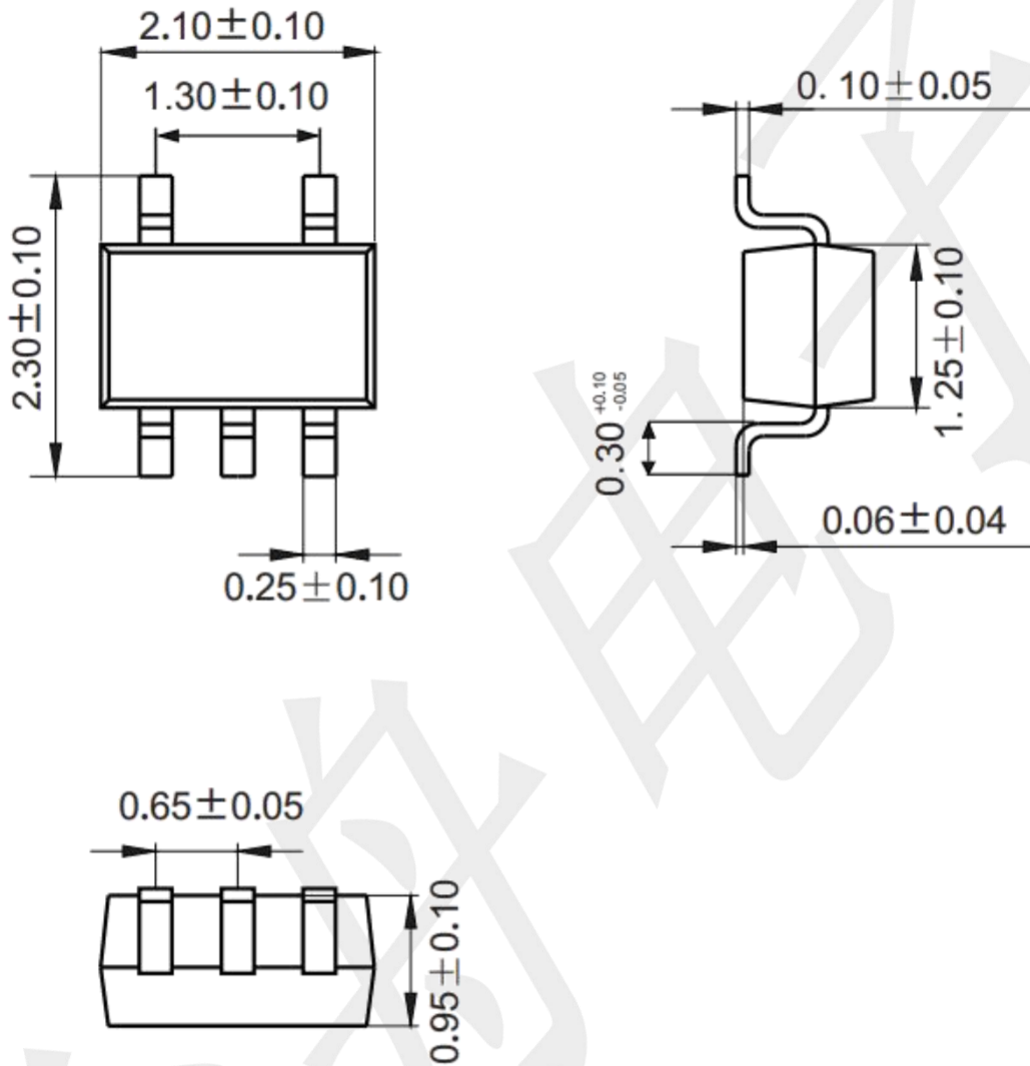

Figure 6. Maximum Safe Operation Area

Package Outline Dimensions (unit: mm)

SOT-353



Mounting Pad Layout (unit: mm)

