

# TPS560430-Q1 SIMPLE SWITCHER<sup>®</sup> 4-V to 36-V, 600-mA Synchronous Buck Converter

## 1 Features

- Qualified for automotive applications
- AEC-Q100 Qualified
  - Temperature grade 1: -40°C to 125°C ambient operating temperature range
  - ESD HBM classification level 2
  - ESD CDM classification level C5
- Configured for rugged automotive applications
  - Input voltage range: 4 V to 36 V
  - 600-mA continuous output current
  - Minimum switching-on time: 60 ns
  - Fixed 2.1MHz frequency
  - 98% maximum duty cycle
  - Support startup with pre-biased output
  - Short circuit protection with hiccup mode
  - ±0.5% tolerance voltage reference at room temperature
  - Precision enable
- Small solution size and ease of use
  - Integrated synchronous rectification
  - Internal compensation for ease of use
  - SOT-23-6 package
- Two modes in pin-to-pin compatible package
  - PFM and forced PWM (FPWM) options
- Create a custom design using the TPS560430-Q1 with the [WEBENCH<sup>®</sup> Power Designer](#)

## 2 Applications

- Camera
- On-board charger
- Automotive head unit
- USB charger
- General purpose wide  $V_{IN}$  power supplies

## 3 Description

The TPS560430-Q1 is a wide- $V_{IN}$ , easy to use synchronous buck converter capable of driving up to 600-mA load current. With a wide input range of 4 V to 36 V, the device is suitable for a wide range of automotive applications for power conditioning from an unregulated source.

TPS560430-Q1 operates at 2.1-MHz switching frequency to support use of relatively small inductors for an optimized solution size. It has Eco-mode version to realize high efficiency at light load and FPWM version to achieve constant frequency, small output voltage ripple over the full load range. Soft-start and compensation circuits are implemented internally which allows the device to be used with minimum external components.

The device has built-in protection features, such as cycle-by-cycle current limit, hiccup mode short-circuit protection, and thermal shutdown in case of excessive power dissipation. The TPS560430-Q1 is available in SOT-23-6 package.

### Device Information (1)

PART NUMBER	PACKAGE	BODY SIZE (NOM)
TPS560430-Q1	SOT-23-6	2.90 mm x 1.60 mm

(1) For all available packages, see the orderable addendum at the end of the data sheet.

### Simplified Schematic

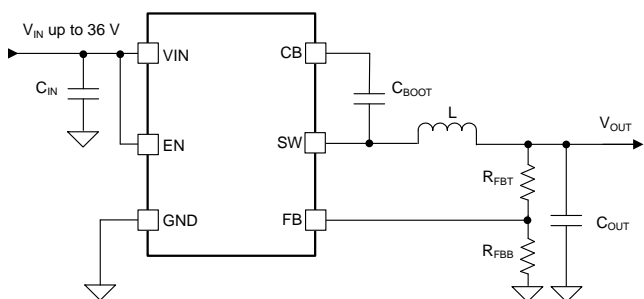

Copyright © 2017, Texas Instruments Incorporated

### Efficiency vs Output Current

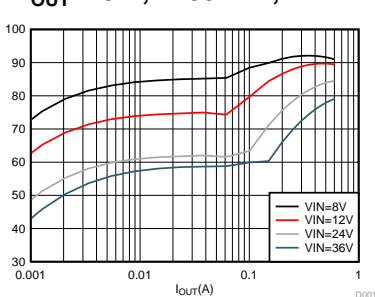

## Table of Contents

<b>1 Features</b> .....	<b>1</b>	8.3 Feature Description .....	<b>10</b>
<b>2 Applications</b> .....	<b>1</b>	8.4 Device Functional Modes .....	<b>14</b>
<b>3 Description</b> .....	<b>1</b>	<b>9 Application and Implementation</b> .....	<b>15</b>
<b>4 Revision History</b> .....	<b>2</b>	9.1 Application Information .....	<b>15</b>
<b>5 Device Comparison Table</b> .....	<b>3</b>	9.2 Typical Application .....	<b>15</b>
<b>6 Pin Configuration and Functions</b> .....	<b>3</b>	<b>10 Power Supply Recommendations</b> .....	<b>22</b>
<b>7 Specifications</b> .....	<b>4</b>	<b>11 Layout</b> .....	<b>22</b>
7.1 Absolute Maximum Ratings .....	<b>4</b>	11.1 Layout Guidelines .....	<b>22</b>
7.2 ESD Ratings .....	<b>4</b>	11.2 Layout Example .....	<b>23</b>
7.3 Recommended Operating Conditions .....	<b>4</b>	<b>12 Device and Documentation Support</b> .....	<b>24</b>
7.4 Thermal Information .....	<b>4</b>	12.1 Device Support .....	<b>24</b>
7.5 Electrical Characteristics .....	<b>5</b>	12.2 Documentation Support .....	<b>24</b>
7.6 Timing Requirements .....	<b>6</b>	12.3 Receiving Notification of Documentation Updates .....	<b>24</b>
7.7 Switching Characteristics .....	<b>6</b>	12.4 Community Resources .....	<b>24</b>
7.8 Typical Characteristics .....	<b>7</b>	12.5 Trademarks .....	<b>24</b>
<b>8 Detailed Description</b> .....	<b>9</b>	12.6 Electrostatic Discharge Caution .....	<b>24</b>
8.1 Overview .....	<b>9</b>	12.7 Glossary .....	<b>25</b>
8.2 Functional Block Diagram .....	<b>9</b>	<b>13 Mechanical, Packaging, and Orderable Information</b> .....	<b>25</b>

## 4 Revision History

NOTE: Page numbers for previous revisions may differ from page numbers in the current version.

<b>Changes from Original (January 2019) to Revision A</b>	<b>Page</b>
• Changed marketing status from Advance Information to Production Data. ....	<b>1</b>

## 5 Device Comparison Table

ORDERABLE PART NUMBER	Frequency	PFM or FPWM	Output
TPS560430YQDBVRQ1	2.1 MHz	PFM	Adjustable
TPS560430YFQDBVRQ1	2.1 MHz	FPWM	Adjustable

## 6 Pin Configuration and Functions

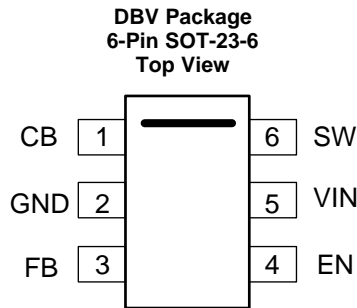

### Pin Functions

PIN		TYPE <sup>(1)</sup>	DESCRIPTION
NAME	NO		
CB	1	P	Bootstrap capacitor connection for high-side FET driver. Connect a high quality 100nF capacitor from this pin to the SW pin.
GND	2	A	Power ground terminals, connected to the source of low-side FET internally. Connect to system ground, ground side of $C_{IN}$ and $C_{OUT}$ . Path to $C_{IN}$ must be as short as possible.
FB	3	A	Feedback input to the converter. Connect a resistor divider to set the output voltage. Never short this terminal to ground during operation.
EN	4	A	Precision enable input to the converter. Do not float. High = on, Low = off. Can be tied to VIN. Precision enable input allows adjustable UVLO by external resistor divider.
VIN	5	P	Supply input terminal to internal bias LDO and high-side FET. Connect to input supply and input bypass capacitors $C_{IN}$ . Input bypass capacitors must be directly connected to this pin and GND.
SW	6	P	Switching output of the converter. Internally connected to source of the high-side FET and drain of the low-side FET. Connect to power inductor.

(1) A = Analog, P = Power, G = Ground.

## 7 Specifications

### 7.1 Absolute Maximum Ratings

Over the recommended operating junction temperature range of  $-40\text{ }^{\circ}\text{C}$  to  $125\text{ }^{\circ}\text{C}$  (unless otherwise noted) <sup>(1)</sup>

PARAMETER		MIN	MAX	UNIT
Input Voltages	VIN to GND	-0.3	38	V
	EN to GND	-0.3	$V_{IN} + 0.3$	
	FB to GND	-0.3	5.5	
Output Voltages	SW to GND	-0.3	$V_{IN} + 0.3$	V
	SW to GND less than 10 ns transient	-3.5	38	
	CB to SW	-0.3	5.5	
T <sub>J</sub>	Junction temperature <sup>(2)</sup>	-40	150	°C
T <sub>stg</sub>	Storage temperature	-65	150	

- (1) Stresses beyond those listed under [Absolute Maximum Ratings](#) may cause permanent damage to the device. These are stress ratings only, which do not imply functional operation of the device at these or any other conditions beyond those indicated under [Recommended Operating Conditions](#). Exposure to absolute-maximum-rated conditions for extended periods may affect device reliability.
- (2) Operating at junction temperatures greater than  $125\text{ }^{\circ}\text{C}$ , although possible, degrades the lifetime of the device.

### 7.2 ESD Ratings

		VALUE	UNIT
V <sub>(ESD)</sub>	Electrostatic discharge	Human-body model (HBM), per AEC Q100-002 <sup>(1)</sup>	±2500
		Charged-device model (CDM), per AEC Q100-011	±750

- (1) AEC Q100-002 indicates that HBM stressing shall be in accordance with the ANSI/ESDA/JEDEC JS-001 specification.

### 7.3 Recommended Operating Conditions

Over the recommended operating junction temperature range of  $-40\text{ }^{\circ}\text{C}$  to  $125\text{ }^{\circ}\text{C}$  (unless otherwise noted) <sup>(1)</sup>

PARAMETER		MIN	MAX	UNIT
Input Voltages	VIN to GND	4	36	V
	EN	0	$V_{IN}$	
	FB	0	4.5	
Output Voltage	V <sub>OUT</sub>	1.0	95% of $V_{IN}$	V
Output Current	I <sub>OUT</sub>	0	600	mA
Temperature	Operating junction temperature range, T <sub>J</sub>	-40	+125	°C

- (1) [Recommended Operating Conditions](#) indicate conditions for which the device is intended to be functional, but do not guarantee specific performance limits. For guaranteed specifications, see [Electrical Characteristics](#)

### 7.4 Thermal Information

THERMAL METRIC <sup>(1)</sup>		DBV (6 PINS)	UNIT
R <sub>θJA</sub> <sup>(2)</sup>	Junction-to-ambient thermal resistance	173	°C/W
R <sub>θJC_T</sub>	Junction-to-case (TOP) thermal resistance	116	°C/W
R <sub>θJC_B</sub>	Junction-to-case (BOTTOM) thermal resistance	31	°C/W
ψ <sub>JT</sub>	Junction-to-top characterization parameter	20	°C/W
ψ <sub>JB</sub>	Junction-to-board characterization parameter	30	°C/W

- (1) For more information about traditional and new thermal metrics, see the *Semiconductor and IC Package Thermal Metrics* application report, [SPRA953](#)
- (2) The value of R<sub>θJA</sub> given in this table is only valid for comparison with other packages and can not be used for design purposes. These values were calculated in accordance with JESD 51-7, and simulated on a specified JEDEC board. They do not represent the performance obtained in an actual application.

## 7.5 Electrical Characteristics

Limits apply over the recommended operating junction temperature ( $T_J$ ) range of  $-40^{\circ}\text{C}$  to  $+125^{\circ}\text{C}$ , unless otherwise stated. Minimum and maximum limits are specified through test, design or statistical correlation. Typical values represent the most likely parametric norm at  $T_J = 25^{\circ}\text{C}$ , and are provided for reference purposes only. Unless otherwise stated, the following conditions apply:  $V_{IN} = 4\text{ V}$  to  $36\text{ V}$ .

PARAMETER	TEST CONDITIONS	MIN	TYP	MAX	UNIT		
<b>SUPPLY VOLTAGE (VIN PIN)</b>							
$V_{IN}$	Operation input voltage	4		36	V		
$V_{IN\_UVLO}$	Undervoltage lockout thresholds	Rising threshold	3.55	3.75	4.00	V	
		Falling threshold	3.25	3.45	3.65		
		Hysteresis		0.3			
$I_Q$	Operating quiescent current (non-switching)	PFM version, $V_{EN} = 3.3\text{ V}$ , $V_{FB} = 1.1\text{ V}$		80	120	$\mu\text{A}$	
$I_{SHDN}$	Shutdown current	$V_{EN} = 0\text{ V}$		3	10	$\mu\text{A}$	
<b>ENABLE (EN PIN)</b>							
$V_{EN\_H}$	Enable rising threshold voltage	1.1	1.23	1.36	V		
$V_{EN\_L}$	Enable falling threshold voltage	0.95	1.1	1.22	V		
$V_{EN\_HYS}$	Enable hysteresis voltage		0.13		V		
$I_{EN}$	Leakage current at EN pin	$V_{EN} = 3.3\text{ V}$		10	200	nA	
<b>VOLTAGE REFERENCE (FB PIN)</b>							
$V_{REF}$	Reference voltage	$T_J = 25^{\circ}\text{C}$		0.995	1.00	1.005	V
		$T_J = -40^{\circ}\text{C}$ to $125^{\circ}\text{C}$		0.985	1.00	1.015	V
$I_{FB}$	Leakage current at FB pin	$V_{FB} = 1.2\text{ V}$		0.2	50	nA	
<b>CURRENT LIMITS AND HICCUP</b>							
$I_{HS\_LIMIT}$	Peak inductor current limit	0.8	1.1	1.4	A		
$I_{LS\_LIMIT}$	Valley inductor current limit	0.62	0.8	0.98	A		
$I_{LS\_ZC}$	Zero cross current (PFM version)		20		mA		
$I_{LS\_NEG}$	Negative current limit (FPWM version)	-0.7	-0.5	-0.3	A		
$V_{HICCUP}$	Hiccup threshold of FB pin	% of reference voltage		40%			
<b>INTEGRATED MOSFETS</b>							
$R_{DS\_ON\_HS}$	High-side MOSFET ON-resistance	$T_J = 25^{\circ}\text{C}$ , $V_{IN} = 12\text{ V}$		450	$\text{m}\Omega$		
$R_{DS\_ON\_LS}$	Low-side MOSFET ON-resistance	$T_J = 25^{\circ}\text{C}$ , $V_{IN} = 12\text{ V}$		240	$\text{m}\Omega$		
<b>THERMAL SHUTDOWN <sup>(1)</sup></b>							
$T_{SHDN}$	Thermal shutdown threshold		170		$^{\circ}\text{C}$		
$T_{HYS}$	Hysteresis		12		$^{\circ}\text{C}$		

(1) Ensured by design.

## 7.6 Timing Requirements

Limits apply over the recommended operating junction temperature ( $T_J$ ) range of  $-40^{\circ}\text{C}$  to  $+125^{\circ}\text{C}$ , unless otherwise stated. Minimum and maximum limits are specified through test, design or statistical correlation. Typical values represent the most likely parametric norm at  $T_J = 25^{\circ}\text{C}$ , and are provided for reference purposes only. Unless otherwise stated, the following conditions apply:  $V_{IN} = 4\text{ V}$  to  $36\text{ V}$ .

PARAMETER		TEST CONDITIONS	MIN	TYP	MAX	UNIT
<b>SOFT START</b>						
$T_{SS}$	Internal soft-start time	The time of internal reference to increase from 10% to 90% of $V_{REF}$ , $V_{IN} = 12\text{ V}$		1.8		ms
<b>HICCUP</b>						
$T_{HICCUP}$	Hiccup time	$V_{IN} = 12\text{ V}$		135		ms

## 7.7 Switching Characteristics

Limits apply over the recommended operating junction temperature ( $T_J$ ) range of  $-40^{\circ}\text{C}$  to  $+125^{\circ}\text{C}$ , unless otherwise stated. Minimum and maximum limits are specified through test, design or statistical correlation. Typical values represent the most likely parametric norm at  $T_J = 25^{\circ}\text{C}$ , and are provided for reference purposes only. Unless otherwise stated, the following conditions apply:  $V_{IN} = 4\text{ V}$  to  $36\text{ V}$ .

PARAMETER		TEST CONDITIONS	MIN	TYP	MAX	UNIT
<b>SWITCHING NODE (SW PIN)</b>						
$t_{ON\_MIN}$	Minimum turn-on time	$I_{OUT} = 600\text{ mA}$		60		ns
$t_{OFF\_MIN}$	Minimum turn-off time	$I_{OUT} = 600\text{ mA}$		100		ns
$t_{ON\_MAX}$	Maximum turn-on time			7.5		$\mu\text{s}$
<b>OSCILLATOR</b>						
$f_{SW}$	Oscillator frequency	2.1-MHz version	1.785	2.1	2.415	MHz

### 7.8 Typical Characteristics

$V_{IN} = 12\text{ V}$ ,  $T_A = 25^\circ\text{C}$ , unless otherwise specified.

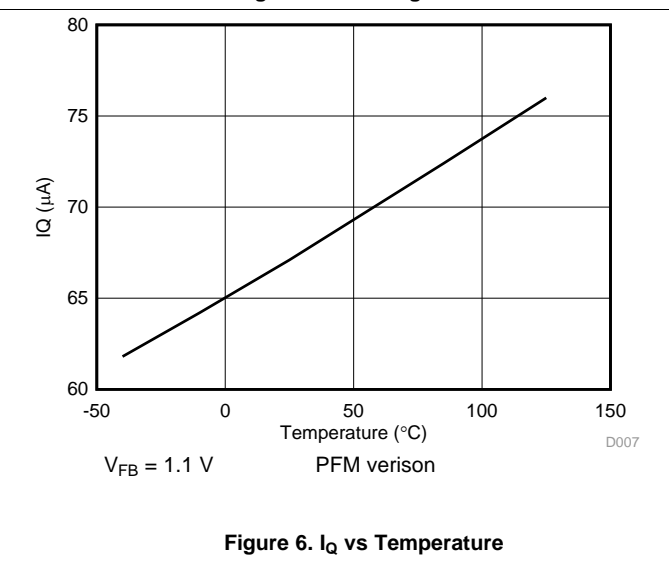
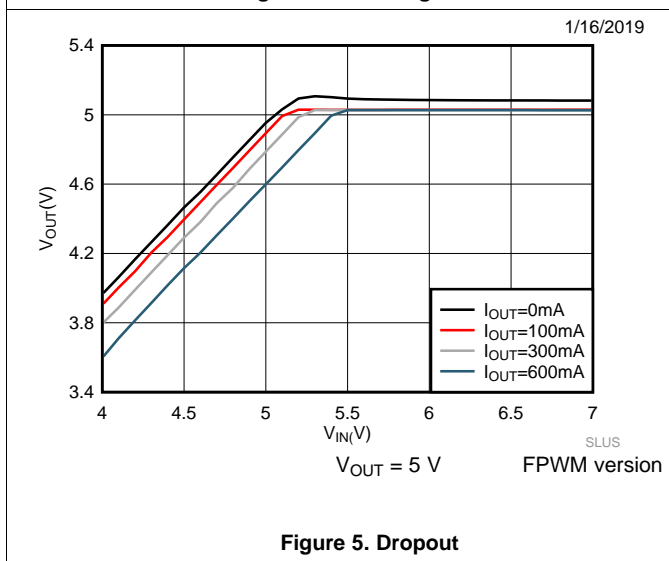
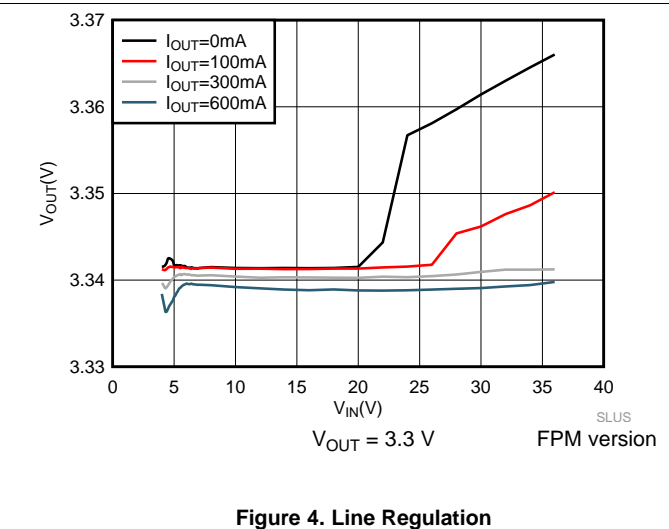
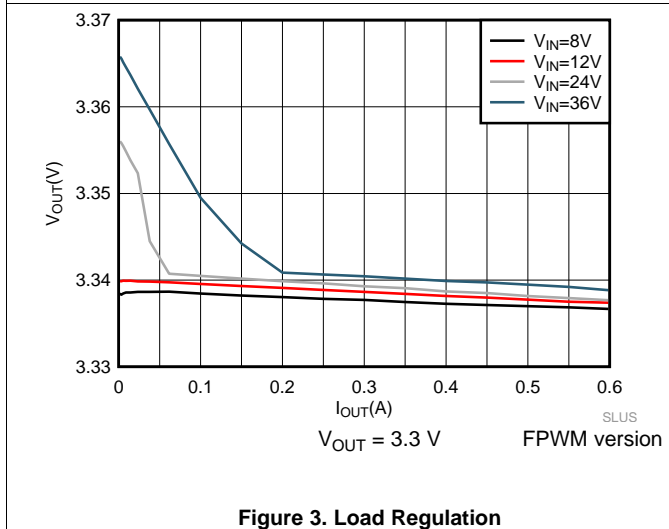
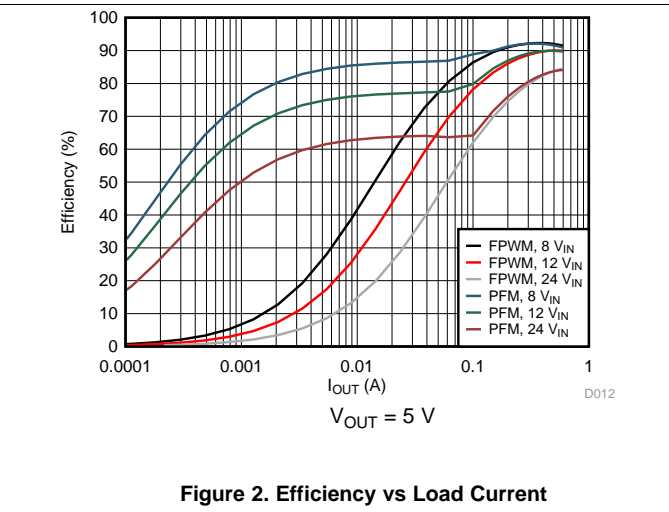
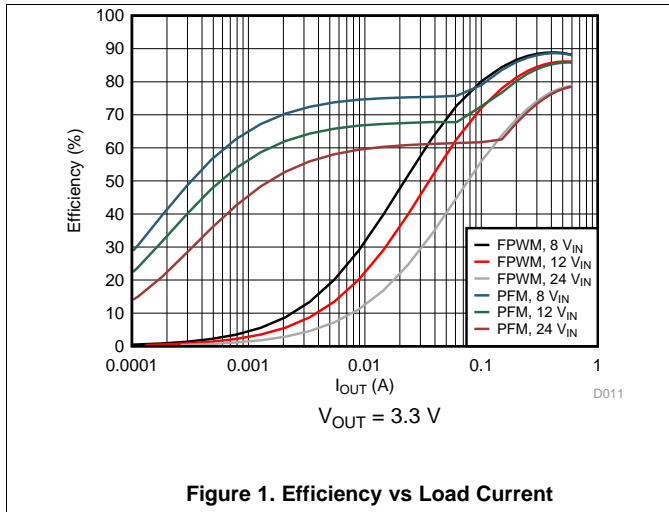

**Typical Characteristics (continued)**

$V_{IN} = 12\text{ V}$ ,  $T_A = 25^\circ\text{C}$ , unless otherwise specified.

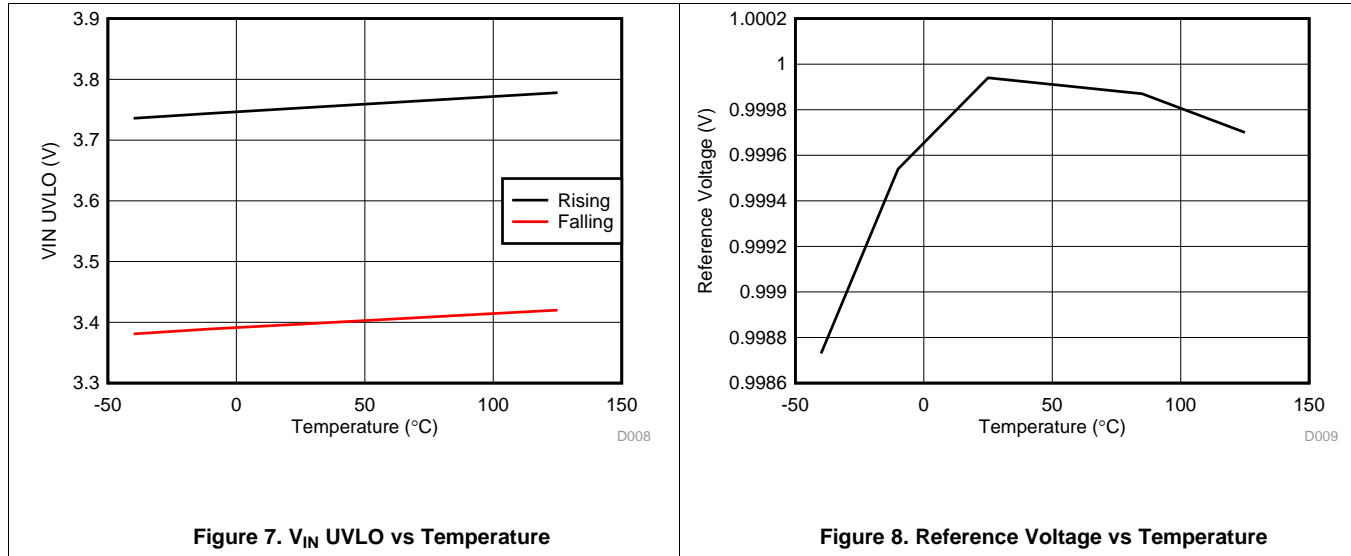

**Figure 7.  $V_{IN}$  UVLO vs Temperature**

**Figure 8. Reference Voltage vs Temperature**

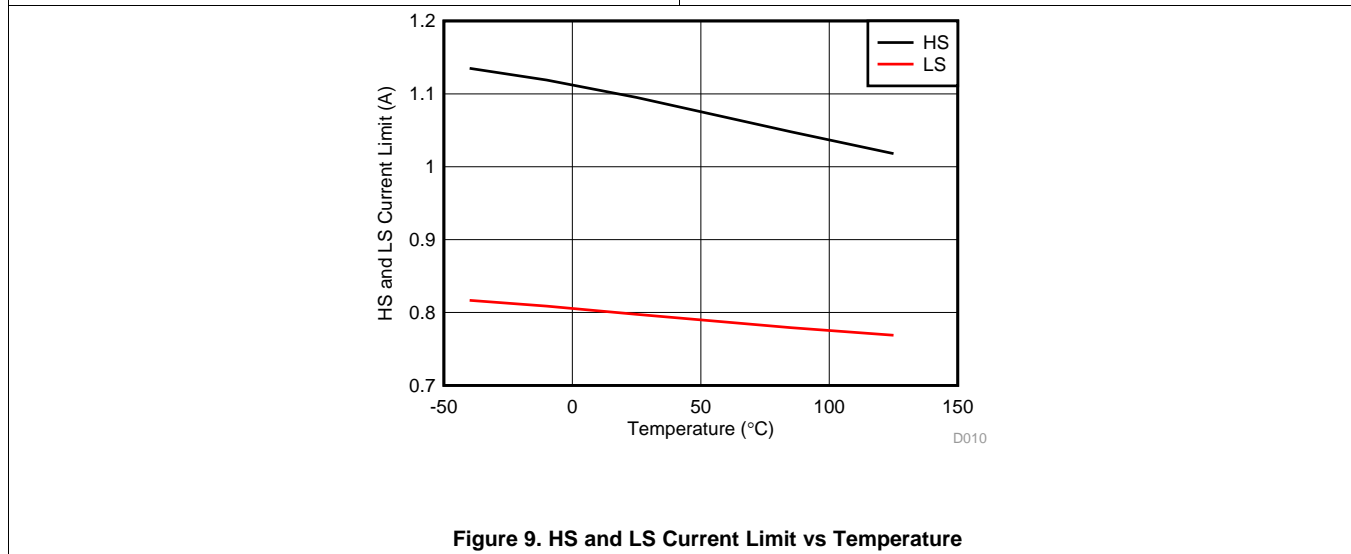

**Figure 9. HS and LS Current Limit vs Temperature**



## 8 Detailed Description

### 8.1 Overview

The TPS560430-Q1 converter is an easy to use synchronous step-down DC-DC converter operating from 4-V to 36-V supply voltage. It is capable of delivering up to 600-mA DC load current in a very small solution size. The family has two versions applicable to various applications, refer to [Device Comparison Table](#) for detailed information.

The TPS560430-Q1 employs fixed-frequency peak-current mode control. The device enters PFM Mode at light load to achieve high efficiency for PFM version. FPWM version is provided to achieve low output voltage ripple, tight output voltage regulation, and constant switching frequency at light load. The device is internally compensated, which reduces design time, and requires few external components.

Additional features such as precision enable and internal soft-start provide a flexible and easy to use solution for a wide range of applications. Protection features include thermal shutdown,  $V_{IN}$  under-voltage lockout, cycle-by-cycle current limit, and hiccup mode short-circuit protection.

The family requires very few external components and has a pin-out designed for simple, optimum PCB layout.

### 8.2 Functional Block Diagram

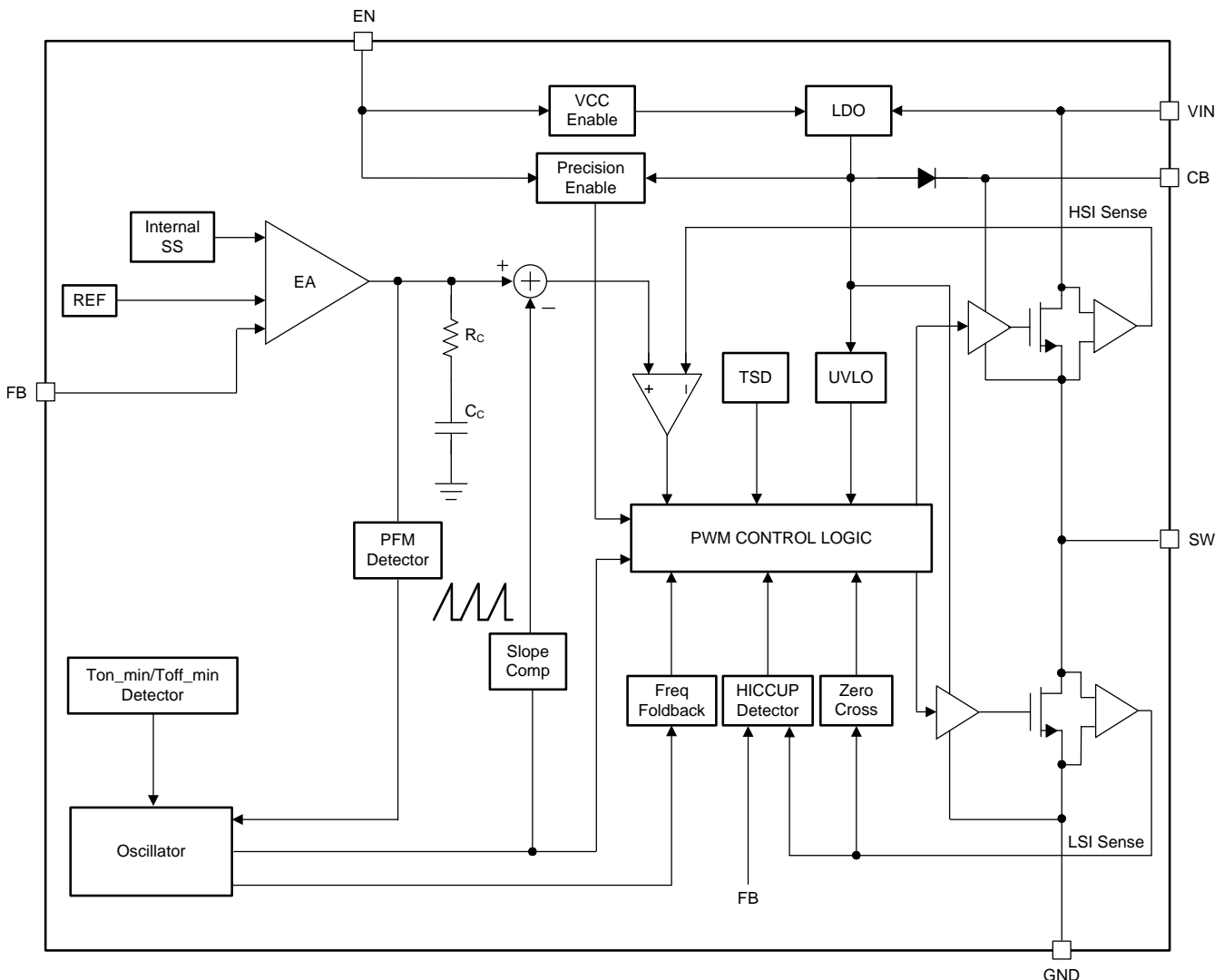

Copyright © 2017, Texas Instruments Incorporated

## 8.3 Feature Description

### 8.3.1 Fixed Frequency Peak Current Mode Control

The following operation description of TPS560430-Q1 will refer to the [Functional Block Diagram](#) and to the waveforms in [Figure 10](#). TPS560430-Q1 is a step-down synchronous buck converter with integrated high-side (HS) and low-side (LS) switches (synchronous rectifier). The TPS560430-Q1 supplies a regulated output voltage by turning on the high-side and low side NMOS switches with controlled duty cycle. During high-side switch ON time, the SW pin voltage swings up to approximately  $V_{IN}$ , and the inductor current  $i_L$  increases with linear slope  $(V_{IN} - V_{OUT}) / L$ . When the high-side switch is turned off by the control logic, the low-side switch is turned on after an anti-shoot-through dead time. Inductor current discharges through the low-side switch with a slope of  $-V_{OUT} / L$ . The control parameter of a buck converter is defined as Duty Cycle  $D = t_{ON} / T_{SW}$ , where  $t_{ON}$  is the high-side switch ON time and  $T_{SW}$  is the switching period. The converter control loop maintains a constant output voltage by adjusting the duty cycle  $D$ . In an idea Buck converter, where losses are ignored,  $D$  is proportional to the output voltage and inversely proportional to the input voltage:  $D = V_{OUT} / V_{IN}$ .

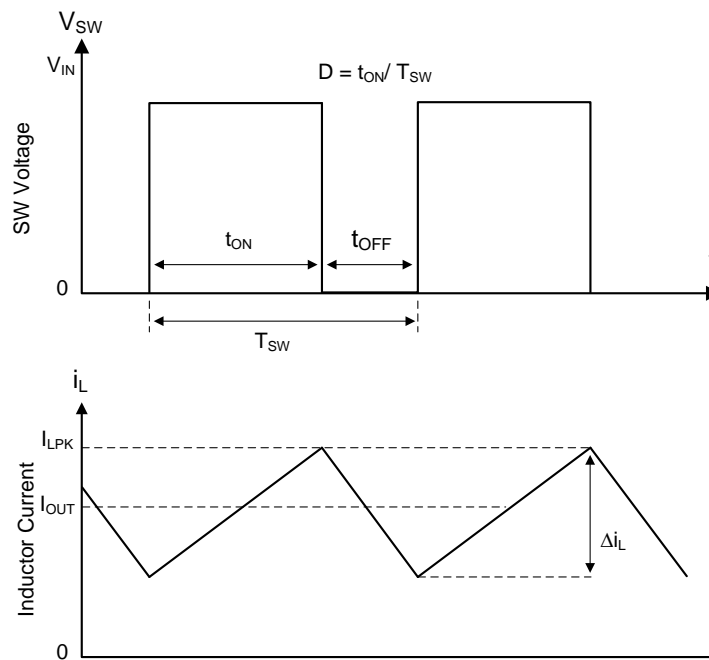

**Figure 10. SW Node and Inductor Current Waveforms in Continuous Conduction Mode (CCM)**

The TPS560430-Q1 employs fixed-frequency peak-current mode control. A voltage feedback loop is used to get accurate DC voltage regulation by adjusting the peak-current command based on voltage offset. The peak inductor current is sensed from the high-side switch and compared to the peak current threshold to control the ON time of the high-side switch. The voltage feedback loop is internally compensated, which allows for fewer external components, makes it easy to design, and provides stable operation with almost any combination of output capacitors. The converter operates with fixed switching frequency at normal load condition. At light-load condition, the TPS560430-Q1 operates in PFM mode to maintain high efficiency (PFM version) or in FPWM mode for low output voltage ripple, tight output voltage regulation, and constant switching frequency (FPWM version).

## Feature Description (continued)

### 8.3.2 Adjustable Output Voltage

A precision 1.0-V reference voltage ( $V_{REF}$ ) is used to maintain a tightly regulated output voltage over the entire operating temperature range. The output voltage is set by a resistor divider from output voltage to the FB pin. It is recommended to use 1% tolerance resistors with a low temperature coefficient for the FB divider. Select the bottom-side resistor  $R_{FBB}$  for the desired divider current and use [Device Support](#) to calculate top-side resistor  $R_{FBT}$ .  $R_{FBT}$  in the range from 10 k $\Omega$  to 100 k $\Omega$  is recommended for most applications. A lower  $R_{FBT}$  value can be used if static loading is desired to reduce  $V_{OUT}$  offset in PFM operation. Lower  $R_{FBT}$  reduces efficiency at very light load. Less static current goes through a larger  $R_{FBT}$  and might be more desirable when light-load efficiency is critical. But  $R_{FBT}$  larger than 1 M $\Omega$  is not recommended because it makes the feedback path more susceptible to noise. Larger  $R_{FBT}$  value requires more carefully designed feedback path on the PCB. The tolerance and temperature variation of the resistor dividers affect the output voltage regulation.

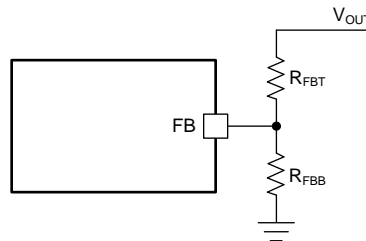

Figure 11. Output Voltage Setting

$$R_{FBT} = \frac{V_{OUT} - V_{REF}}{V_{REF}} \times R_{FBB} \quad (1)$$

### 8.3.3 Enable

The voltage on the EN pin controls the ON or OFF operation of TPS560430-Q1. A voltage of less than 0.95 V shuts down the device, while a voltage of more than 1.36 V is required to start the converter. The EN pin is an input and cannot be left open or floating. The simplest way to enable the operation of the TPS560430-Q1 is to connect the EN to  $V_{IN}$ . This allows self-start-up of the TPS560430-Q1 when  $V_{IN}$  is within the operating range.

Many applications will benefit from the employment of an enable divider  $R_{ENT}$  and  $R_{ENB}$  (Figure 12) to establish a precision system UVLO level for the converter. System UVLO can be used for supplies operating from utility power as well as battery power. It can be used for sequencing, ensuring reliable operation, or supply protection, such as a battery discharge level. An external logic signal can also be used to drive EN input for system sequencing and protection. Kindly note that, the EN pin voltage should never be higher than  $V_{IN} + 0.3$  V. It is not recommended to apply EN voltage when  $V_{IN}$  is 0 V.

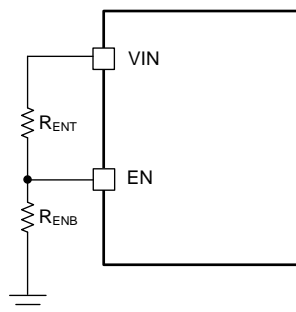

Figure 12. System UVLO by Enable Divider

## Feature Description (continued)

### 8.3.4 Minimum ON-Time, Minimum OFF-Time and Frequency Foldback

Minimum ON-time( $T_{ON\_MIN}$ ) is the smallest duration of time that the high-side switch can be on.  $T_{ON\_MIN}$  is typically 60 ns in the TPS560430-Q1. Minimum OFF-time( $T_{OFF\_MIN}$ ) is the smallest duration that the high-side switch can be off.  $T_{OFF\_MIN}$  is typically 100 ns. In CCM operation,  $T_{ON\_MIN}$  and  $T_{OFF\_MIN}$  limit the voltage conversion range without switching frequency foldback.

The minimum duty cycle without frequency foldback allowed is

$$D_{MIN} = T_{ON\_MIN} \times f_{SW} \tag{2}$$

The maximum duty cycle without frequency foldback allowed is

$$D_{MAX} = 1 - T_{OFF\_MIN} \times f_{SW} \tag{3}$$

Given a required output voltage, the maximum  $V_{IN}$  without frequency foldback can be found by

$$V_{IN\_MAX} = \frac{V_{OUT}}{f_{SW} \times T_{ON\_MIN}} \tag{4}$$

The minimum  $V_{IN}$  without frequency foldback can be calculated by

$$V_{IN\_MIN} = \frac{V_{OUT}}{1 - f_{SW} \times T_{OFF\_MIN}} \tag{5}$$

In the TPS560430-Q1, a frequency foldback scheme is employed once the  $T_{ON\_MIN}$  or  $T_{OFF\_MIN}$  is triggered, which may extend the maximum duty cycle or lower the minimum duty cycle.

The on-time decreases while  $V_{IN}$  voltage increases. Once the on-time decreases to  $T_{ON\_MIN}$ , the switching frequency starts to decrease while  $V_{IN}$  continues to go up, which lowers the duty cycle further to keep  $V_{OUT}$  in regulation according to [Equation 2](#).

The frequency foldback scheme also works once larger duty cycle is needed under low  $V_{IN}$  condition. The frequency decreases once the device hits its  $T_{OFF\_MIN}$ , which extends the maximum duty cycle according to [Equation 3](#). In such condition, the frequency can be as low as about 133 kHz minimum. Wide range of frequency foldback allows the TPS560430-Q1 output voltage stay in regulation with a much lower supply voltage  $V_{IN}$ , which leads to a lower effective drop-out.

With frequency foldback,  $V_{IN\_MAX}$  is raised, and  $V_{IN\_MIN}$  is lowered by decreased  $f_{SW}$ .

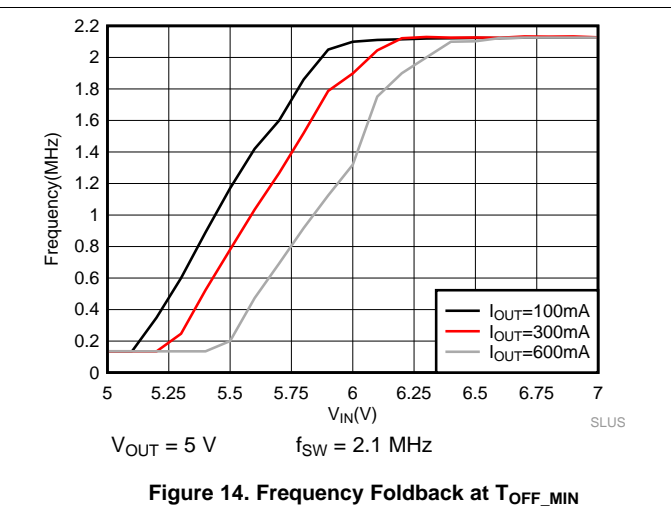
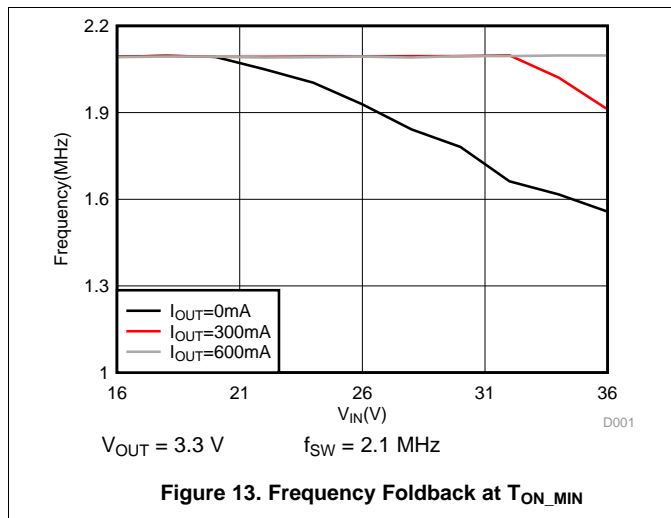

## Feature Description (continued)

### 8.3.5 Bootstrap Voltage

The TPS560430-Q1 provides an integrated bootstrap voltage converter. A small capacitor between the CB and SW pins provides the gate drive voltage for the high-side MOSFET. The bootstrap capacitor is refreshed when the high-side MOSFET is off and the low-side switch conducts. The recommended value of the bootstrap capacitor is 0.1  $\mu\text{F}$ . A ceramic capacitor with an X7R or X5R grade dielectric with a voltage rating of 16 V or higher is recommended for stable performance over temperature and voltage.

### 8.3.6 Over Current and Short Circuit Protection

The TPS560430-Q1 is protected from over-current conditions by cycle-by-cycle current limit on both the peak and valley of the inductor current. Hiccup mode is activated if a fault condition persists to prevent over-heating.

High-side MOSFET over-current protection is implemented by the nature of the Peak Current Mode control. The high-side switch current is sensed when the high-side is turned on after a set blanking time. The high-side switch current is compared to the output of the Error Amplifier (EA) minus slope compensation every switching cycle. Please refer to [Functional Block Diagram](#) for more details. The peak current of high-side switch is limited by a clamped maximum peak current threshold  $I_{\text{high side\_LIMIT}}$  which is constant.

The current going through low-side MOSFET is also sensed and monitored. When the low-side switch turns on, the inductor current begins to ramp down. The low-side switch will not be turned OFF at the end of a switching cycle if its current is above the low-side current limit  $I_{\text{LS\_LIMIT}}$ . The low-side switch is kept ON so that inductor current keeps ramping down, until the inductor current ramps below the  $I_{\text{LS\_LIMIT}}$ . Then the low-side switch will be turned OFF and the high-side switch will be turned on after a dead time. This is somewhat different to the more typical peak current limit, and results in [Equation 6](#) for the maximum load current.

$$I_{\text{OUT\_MAX}} = I_{\text{LS}} + \frac{(V_{\text{IN}} - V_{\text{OUT}})}{2 \times f_{\text{SW}} \times L} \times \frac{V_{\text{OUT}}}{V_{\text{IN}}} \quad (6)$$

If the feedback voltage is lower than 40% of the  $V_{\text{REF}}$ , the current of the low-side switch triggers  $I_{\text{LS\_LIMIT}}$  for 256 consecutive cycles, hiccup current protection mode is activated. In hiccup mode, the converter shuts down and keeps off for a period of hiccup,  $T_{\text{HICCUP}}$  (135 ms typical), before the TPS560430-Q1 tries to start again. If over-current or short-circuit fault condition still exist, hiccup repeats until the fault condition is removed. Hiccup mode reduces power dissipation under severe over-current conditions, prevents over-heating and potential damage to the device.

For FPWM version, the inductor current is allowed to go negative. When this current exceed the low-side negative current limit  $I_{\text{LS\_NEG}}$ , the low-side switch is turned off and high-side switch is turned on immediately. This is used to protect the low-side switch from excessive negative current.

### 8.3.7 Soft Start

The integrated soft-start circuit prevents input inrush current impacting the TPS560430-Q1 and the input power supply. Soft-start is achieved by slowly ramping up the target regulation voltage when the device is first enabled or powered up. The typical soft-start time is 1.8 ms.

The TPS560430-Q1 also employs over-current protection blanking time  $T_{\text{OCP\_BLK}}$  (33 ms typical) at the beginning of power-up. Without this feature, in applications with a large amount of output capacitors and high  $V_{\text{OUT}}$ , the inrush current is large enough to trigger the current-limit protection, which may make the device entering into hiccup mode. The device tries to restart after the hiccup period, then hit current-limit and enter into hiccup mode again, so  $V_{\text{OUT}}$  cannot ramp up to the setting voltage ever. By introducing OCP blanking feature, the hiccup protection function is disabled during  $T_{\text{OCP\_BLK}}$ , and TPS560430-Q1 charges the  $V_{\text{OUT}}$  with its maximum limited current, which maximizes the output current capacity during this period. Kindly note that, the peak current limit ( $I_{\text{HS\_LIMIT}}$ ) and valley current limit ( $I_{\text{LS\_LIMIT}}$ ) protection function are still available during  $T_{\text{OCP\_BLK}}$ , so there is no concern of inductor current running away.

### 8.3.8 Thermal Shutdown

The TPS560430-Q1 provides an internal thermal shutdown to protect the device when the junction temperature exceeds 170°C. Both high-side and low-side FETs stop switching in thermal shutdown. Once the die temperature falls below 158°C, the device reinitiates the power up sequence controlled by the internal soft-start circuitry.

## 8.4 Device Functional Modes

### 8.4.1 Shutdown Mode

The EN pin provides electrical ON and OFF control for the TPS560430-Q1. When  $V_{EN}$  is below 0.95 V, the device is in shutdown mode. The TPS560430-Q1 also employs  $V_{IN}$  under voltage lock out protection (UVLO). If  $V_{IN}$  voltage is below its UVLO threshold 3.25 V, the converter is turned off.

### 8.4.2 Active Mode

The TPS560430-Q1 is in Active Mode when both  $V_{EN}$  and  $V_{IN}$  are above their respective operating threshold. The simplest way to enable the TPS560430-Q1 is to connect the EN pin to VIN pin. This allows self-startup when the input voltage is in the operating range: 4.0 V to 36 V. Please refer to [Enable](#) section for details on setting these operating levels.

In Active Mode, depending on the load current, the TPS560430-Q1 will be in one of four modes:

1. Continuous conduction mode (CCM) with fixed switching frequency when load current is above half of the peak-to-peak inductor current ripple (for both PFM and FPWM versions).
2. Discontinuous conduction mode (DCM) with fixed switching frequency when load current is lower than half of the peak-to-peak inductor current ripple in CCM operation (only for PFM version).
3. Pulse frequency modulation mode (PFM) when switching frequency is decreased at very light load (only for PFM version).
4. Forced pulse width modulation mode (FPWM) with fixed switching frequency even at light load (only for FPWM version).

### 8.4.3 CCM Mode

Continuous Conduction Mode (CCM) operation is employed in the TPS560430-Q1 when the load current is higher than half of the peak-to-peak inductor current. In CCM operation, the frequency of operation is fixed, output voltage ripple is at a minimum in this mode and the maximum output current of 600 mA can be supplied by the TPS560430-Q1.

### 8.4.4 Light-Load Operation (PFM Version)

For PFM version, when the load current is lower than half of the peak-to-peak inductor current in CCM, the TPS560430-Q1 operates in Discontinuous Conduction Mode (DCM), also known as Diode Emulation Mode (DEM). In DCM operation, the low-side switch is turned off when the inductor current drops to  $I_{LS\_ZC}$  (20 mA typical) to improve efficiency. Both switching losses and conduction losses are reduced in DCM, compared to forced PWM operation at light load.

At even lighter current load, Pulse Frequency Modulation (PFM) mode is activated to maintain high efficiency operation. When either the minimum high-side switch ON time  $t_{ON\_MIN}$  or the minimum peak inductor current  $I_{PEAK\_MIN}$  (150mA typical) is reached, the switching frequency decreases to maintain regulation. In PFM mode, switching frequency is decreased by the control loop to maintain output voltage regulation when load current reduces. Switching loss is further reduced in PFM operation due to less frequent switching actions.

### 8.4.5 Light-Load Operation (FPWM Version)

For FPWM version, TPS560430-Q1 is locked in PWM mode at full load range. This operation is maintained, even in no-load condition, by allowing the inductor current to reverse its normal direction. This mode trades off reduced light load efficiency for low output voltage ripple, tight output voltage regulation, and constant switching frequency.

## 9 Application and Implementation

### NOTE

Information in the following applications sections is not part of the TI component specification, and TI does not warrant its accuracy or completeness. TI's customers are responsible for determining suitability of components for their purposes. Customers should validate and test their design implementation to confirm system functionality.

### 9.1 Application Information

The TPS560430-Q1 is a step down DC-to-DC converter. It is typically used to convert a higher DC voltage to a lower DC voltage with a maximum output current of 600 mA. The following design procedure can be used to select components for the TPS560430-Q1. Alternately, the WEBENCH® software may be used to generate complete designs. When generating a design, the WEBENCH® software utilizes iterative design procedure and accesses comprehensive databases of components. Please go to ti.com for more details.

### 9.2 Typical Application

The TPS560430-Q1 only requires a few external components to convert from a wide voltage range supply to a fixed output voltage. Figure 15 shows a basic schematic.

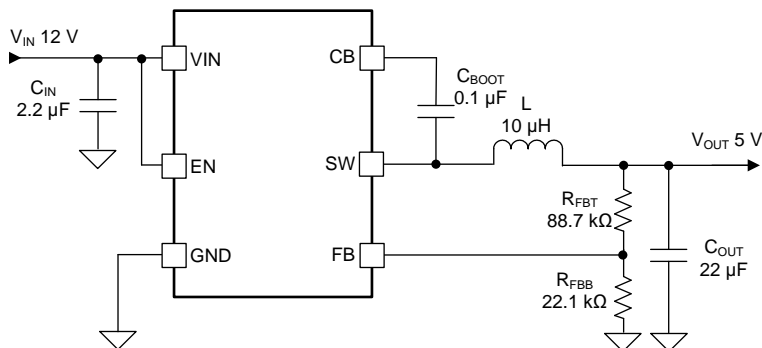

Copyright © 2017, Texas Instruments Incorporated

Figure 15. Application Circuit

The external components have to fulfill the needs of the application and the stability criteria of the device's control loop. Table 1 can be used to simplify the output filter component selection.

Table 1. L and C<sub>OUT</sub> Typical Values

f <sub>sw</sub> (MHz)	V <sub>OUT</sub> (V)	L (μH)	C <sub>OUT</sub> (μF)	R <sub>FBT</sub> (kΩ)	R <sub>FBB</sub> (kΩ)
2.1	3.3	6.8	10 μF / 10 V	51	22.1
	5	10	10 μF / 10 V	88.7	22.1
	12	18	10 μF / 25 V	243	22.1

## 9.2.1 Design Requirements

Detailed design procedure is described based on a design example. For this design example, use the parameters listed in [Table 2](#) as the input parameters.

**Table 2. Design Example Parameters**

PARAMETER	VALUE
Input voltage, $V_{IN}$	12 V typical, range from 6 V to 36 V
Output voltage, $V_{OUT}$	5 V $\pm$ 3%
Maximum output current, $I_{OUT\_MAX}$	600 mA
Minimum output current, $I_{OUT\_MIN}$	30 mA
Output overshoot/ undershoot (0mA to 600mA )	5%
Output voltage ripple	0.5%
Operating frequency	2.1 MHz

## 9.2.2 Detailed Design Procedure

### 9.2.2.1 Custom Design With WEBENCH® Tools

[Click here](#) to create a custom design using the TPS560430-Q1 device with the WEBENCH® Power Designer.

1. Start by entering the input voltage ( $V_{IN}$ ), output voltage ( $V_{OUT}$ ), and output current ( $I_{OUT}$ ) requirements.
2. Optimize the design for key parameters such as efficiency, footprint, and cost using the optimizer dial.
3. Compare the generated design with other possible solutions from Texas Instruments.

The WEBENCH Power Designer provides a customized schematic along with a list of materials with real-time pricing and component availability.

In most cases, these actions are available:

- Run electrical simulations to see important waveforms and circuit performance
- Run thermal simulations to understand board thermal performance
- Export customized schematic and layout into popular CAD formats
- Print PDF reports for the design, and share the design with colleagues

Get more information about WEBENCH tools at [www.ti.com/WEBENCH](http://www.ti.com/WEBENCH).



### 9.2.2.2 Output Voltage Set-Point

The output voltage of the TPS560430-Q1 device is externally adjustable using a resistor divider network. The divider network is comprised of top feedback resistor  $R_{FBT}$  and bottom feedback resistor  $R_{FBB}$ . Equation 7 is used to determine the output voltage of the converter:

$$R_{FBT} = \frac{V_{OUT} - V_{REF}}{V_{REF}} \times R_{FBB} \quad (7)$$

Choose the value of  $R_{FBB}$  to be 22.1 k $\Omega$ . With the desired output voltage set to 5 V and the  $V_{REF} = 1.0$  V, the  $R_{FBT}$  value can then be calculated using Equation 7. The formula yields to a value 88.4 k $\Omega$ , a standard value of 88.7 k $\Omega$  is selected.

### 9.2.2.3 Switching Frequency

The higher switching frequency allows for lower value inductors and smaller output capacitors, which results in smaller solution size and lower component cost. However higher switching frequency brings more switching loss, which makes the solution less efficient and produce more heat. The switching frequency is also limited by the minimum on-time of the integrated power switch, the input voltage, the output voltage and the frequency shift limitation as mentioned in [Minimum ON-Time, Minimum OFF-Time and Frequency Foldback](#) section. For this example, a switching frequency of 2.1 MHz is selected.

### 9.2.2.4 Inductor Selection

The most critical parameters for the inductor are the inductance, saturation current and the RMS current. The inductance is based on the desired peak-to-peak ripple current  $\Delta i_L$ . Since the ripple current increases with the input voltage, the maximum input voltage is always used to calculate the minimum inductance  $L_{MIN}$ . Use Equation 9 to calculate the minimum value of the output inductor.  $K_{IND}$  is a coefficient that represents the amount of inductor ripple current relative to the maximum output current of the device. A reasonable value of  $K_{IND}$  should be 20% to 60%. During an instantaneous over current operation event, the RMS and peak inductor current can be high. The inductor current rating should be a bit higher than current limit.

$$\Delta i_L = \frac{V_{OUT} \times (V_{IN\_MAX} - V_{OUT})}{V_{IN\_MAX} \times L \times f_{SW}} \quad (8)$$

$$L_{MIN} = \frac{V_{IN\_MAX} - V_{OUT}}{I_{OUT} \times K_{IND}} \times \frac{V_{OUT}}{V_{IN\_MAX} \times f_{SW}} \quad (9)$$

In general, it is preferable to choose lower inductance in switching power supplies, because it usually corresponds to faster transient response, smaller DCR, and reduced size for more compact designs. But too low of an inductance can generate too large of an inductor current ripple such that over current protection at the full load could be falsely triggered. It also generates more inductor core loss since the current ripple is larger. Larger inductor current ripple also implies larger output voltage ripple with same output capacitors. With peak current mode control, it is not recommended to have too small of an inductor current ripple. A larger peak current ripple improves the comparator signal to noise ratio.

For this design example, choose  $K_{IND} = 0.4$ , the minimum inductor value is calculated to be 8.6 $\mu$ H. Choose the nearest standard 8.2- $\mu$ H ferrite inductor with a capability of 1-A RMS current and 1.5-A saturation current.

### 9.2.2.5 Output Capacitor Selection

The device is designed to be used with a wide variety of LC filters. It is generally desired to use as little output capacitance as possible to keep cost and size down. The output capacitor (s),  $C_{OUT}$ , should be chosen with care since it directly affects the steady state output voltage ripple, loop stability, output voltage overshoot and undershoot during load current transient. The output voltage ripple is essentially composed of two parts. One is caused by the inductor current ripple going through the Equivalent Series Resistance (ESR) of the output capacitors:

$$\Delta V_{OUT\_ESR} = \Delta i_L \times ESR = K_{IND} \times I_{OUT} \times ESR \quad (10)$$

The other is caused by the inductor current ripple charging and discharging the output capacitors:

$$\Delta V_{OUT\_C} = \frac{\Delta i_L}{8 \times f_{SW} \times C_{OUT}} = \frac{K_{IND} \times I_{OUT}}{8 \times f_{SW} \times C_{OUT}} \quad (11)$$

The two components in the voltage ripple are not in phase, so the actual peak-to-peak ripple is smaller than the sum of the two peaks.

Output capacitance is usually limited by transient performance specifications if the system requires tight voltage regulation with presence of large current steps and fast slew rate. When a large load step happens, output capacitors provide the required charge before the inductor current can slew up to the appropriate level. The converter's control loop usually needs 8 or more clock cycles to regulate the inductor current equal to the new load level. The output capacitance must be large enough to supply the current difference for 8 clock cycles to maintain the output voltage within the specified range. Equation 12 shows the minimum output capacitance needed for specified  $V_{OUT}$  overshoot and undershoot.

$$C_{OUT} > \frac{1}{2} \times \frac{8 \times (I_{OH} - I_{OL})}{f_{SW} \times \Delta V_{OUT\_SHOOT}} \quad (12)$$

where

- $K_{IND}$  = Ripple ratio of the inductor current ( $\Delta i_L / I_{OUT}$ )
- $I_{OL}$  = Low level output current during load transient
- $I_{OH}$  = High level output current during load transient
- $V_{OUT\_SHOOT}$  = Target output voltage overshoot or undershoot

For this design example, the target output ripple is 30 mV. Presuppose  $\Delta V_{OUT\_ESR} = \Delta V_{OUT\_C} = 30$  mV, and chose  $K_{IND} = 0.4$ . Equation 10 yields ESR no larger than 125 m $\Omega$  and Equation 11 yields  $C_{OUT}$  no smaller than 0.91  $\mu$ F. For the target overshoot and undershoot limitation of this design,  $\Delta V_{OUT\_SHOOT} = 5\% \times V_{OUT} = 250$  mV. The  $C_{OUT}$  can be calculated to be no smaller than 4.3  $\mu$ F by Equation 12. In summary, the most stringent criteria for the output capacitor is 4.3  $\mu$ F. Consider of derating, one 10- $\mu$ F, 10-V, X7R ceramic capacitor with 10-m $\Omega$  ESR is used.

### 9.2.2.6 Input Capacitor Selection

The TPS560430-Q1 device requires high frequency input decoupling capacitor(s). The typical recommended value for the high frequency decoupling capacitor is 2.2  $\mu\text{F}$  or higher. A high-quality ceramic type X5R or X7R with sufficiency voltage rating is recommended. The voltage rating must be greater than the maximum input voltage. To compensate the derating of ceramic capacitors, a voltage rating of twice the maximum input voltage is recommended. For this design, one 2.2- $\mu\text{F}$ , X7R dielectric capacitor rated for 50 V is used for the input decoupling capacitor. The equivalent series resistance (ESR) is approximately 10 m $\Omega$ , and the current rating is 1 A. Include a capacitor with a value of 0.1  $\mu\text{F}$  for high-frequency filtering and place it as close as possible to the device pins.

### 9.2.2.7 Bootstrap Capacitor

Every TPS560430-Q1 design requires a bootstrap capacitor,  $C_{\text{BOOT}}$ . The recommended bootstrap capacitor is 0.1  $\mu\text{F}$  and rated at 16 V or higher. The bootstrap capacitor is located between the SW pin and the CB pin. The bootstrap capacitor must be a high-quality ceramic type with X7R or X5R grade dielectric for temperature stability.

### 9.2.2.8 Under Voltage Lockout Set-Point

The system under voltage lockout (UVLO) is adjusted using the external voltage divider network of  $R_{\text{ENT}}$  and  $R_{\text{ENB}}$ . The UVLO has two thresholds, one for power up when the input voltage is rising and one for power down or brown outs when the input voltage is falling. The following equation can be used to determine the  $V_{\text{IN}}$  UVLO level.

$$V_{\text{IN\_RISING}} = V_{\text{ENH}} \times \frac{R_{\text{ENT}} + R_{\text{ENB}}}{R_{\text{ENB}}} \quad (13)$$

The EN rising threshold ( $V_{\text{ENH}}$ ) for TPS560430-Q1 is set to be 1.23 V (typical). Choose the value of  $R_{\text{ENB}}$  to be 200 k $\Omega$  to minimize input current from the supply. If the desired  $V_{\text{IN}}$  UVLO level is at 6.0 V, then the value of  $R_{\text{ENT}}$  can be calculated using [Equation 14](#):

$$R_{\text{ENT}} = \left( \frac{V_{\text{IN\_RISING}}}{V_{\text{ENH}}} - 1 \right) \times R_{\text{ENB}} \quad (14)$$

The above equation yields a value of 775.6 k $\Omega$ , a standard value of 768 k $\Omega$  is selected. The resulting falling UVLO threshold, equals 5.3 V, can be calculated by [Equation 15](#), where EN hysteresis voltage,  $V_{\text{EN\_HYS}}$ , is 0.13 V (typical).

$$V_{\text{IN\_FALLING}} = (V_{\text{ENH}} - V_{\text{EN\_HYS}}) \times \frac{R_{\text{ENT}} + R_{\text{ENB}}}{R_{\text{ENB}}} \quad (15)$$

### 9.2.3 Application Curves

Unless otherwise specified the following conditions apply:  $V_{IN} = 12\text{ V}$ ,  $V_{OUT} = 5\text{ V}$ ,  $f_{SW} = 2.1\text{ MHz}$ ,  $L = 8.2\text{ }\mu\text{H}$ ,  $C_{OUT} = 10\text{ }\mu\text{F}$ ,  $T_A = 25\text{ }^\circ\text{C}$

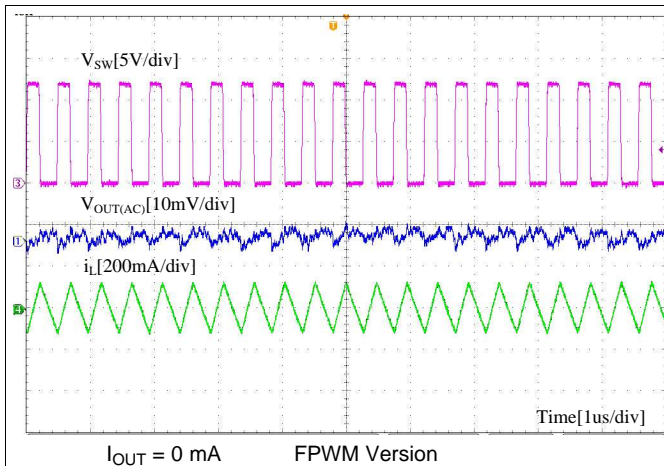

Figure 16. Ripple at No Load

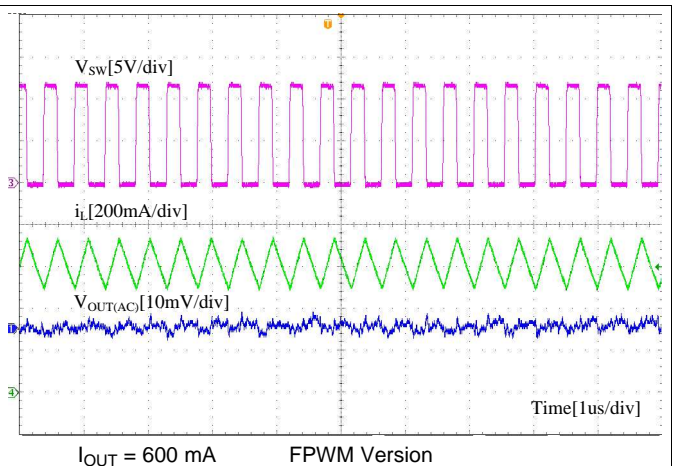

Figure 17. Ripple at Full Load

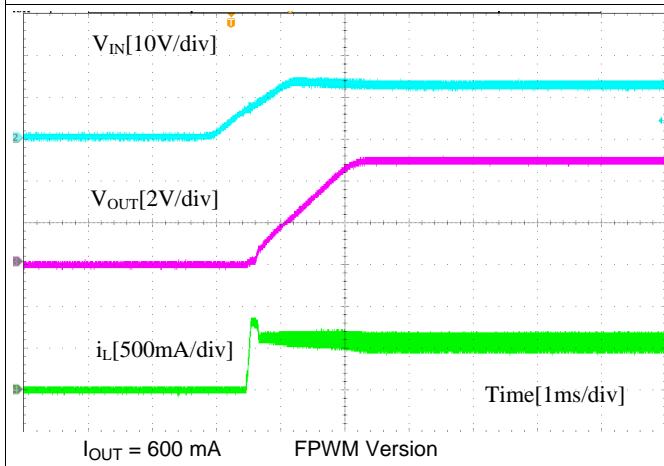

Figure 18. Start Up by  $V_{IN}$

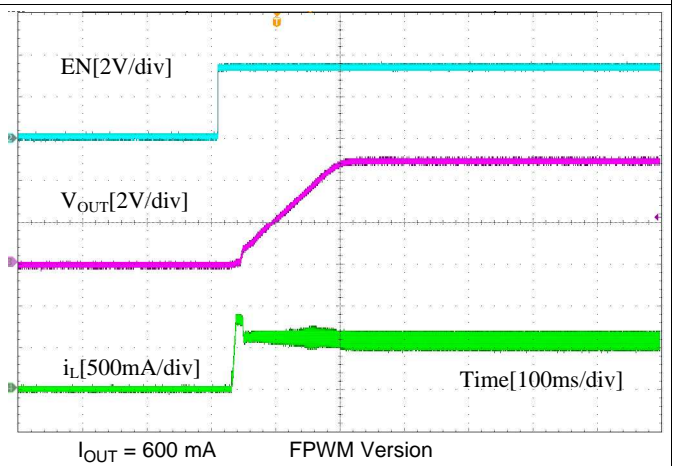

Figure 19. Start-Up by EN

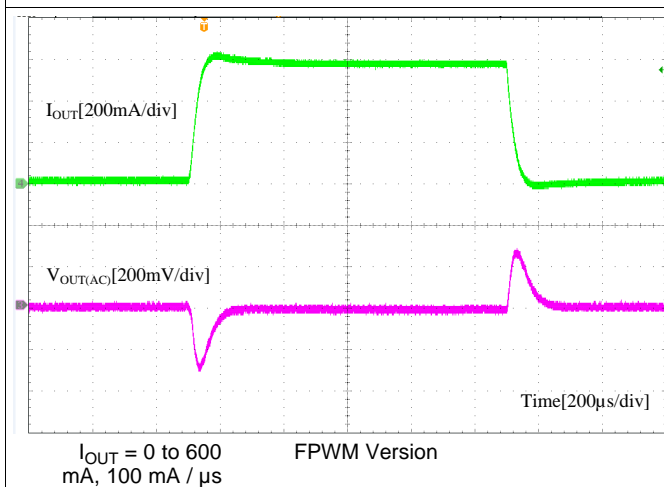

Figure 20. Load Transient

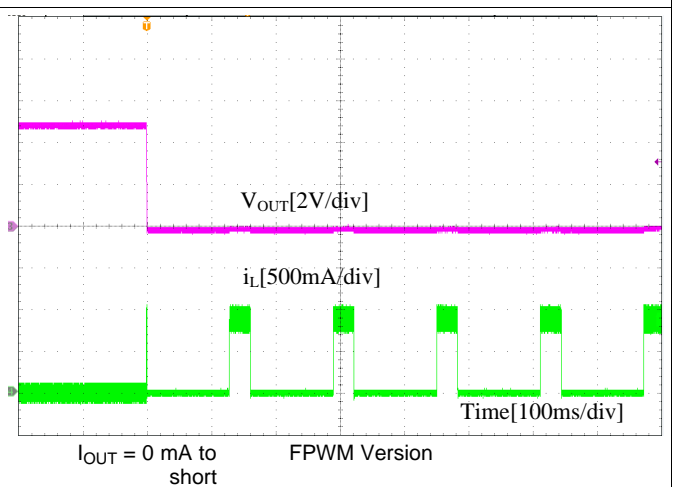

Figure 21. Short Protection

Unless otherwise specified the following conditions apply:  $V_{IN} = 12\text{ V}$ ,  $V_{OUT} = 5\text{ V}$ ,  $f_{SW} = 2.1\text{ MHz}$ ,  $L = 8.2\text{ }\mu\text{H}$ ,  $C_{OUT} = 10\text{ }\mu\text{F}$ ,  $T_A = 25\text{ }^\circ\text{C}$

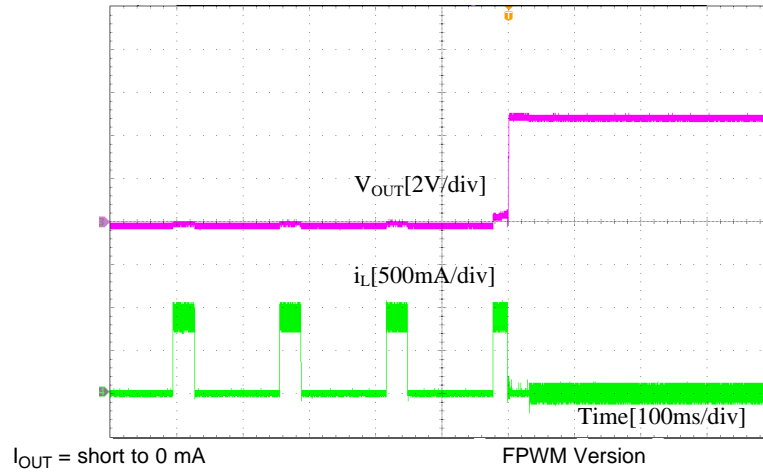

Figure 22. Short Recovery

## 10 Power Supply Recommendations

The TPS560430-Q1 is designed to operate from an input voltage supply range between 4.0 V and 36 V. This input supply should be well regulated and able to withstand maximum input current and maintain a stable voltage. The resistance of the input supply rail should be low enough that an input current transient does not cause a high enough drop at the TPS560430-Q1 supply voltage that can cause a false UVLO fault triggering and system reset. If the input supply is located more than a few inches from the TPS560430-Q1 additional bulk capacitance may be required in addition to the ceramic bypass capacitors. The amount of bulk capacitance is not critical, but a 10- $\mu$ F or 22- $\mu$ F electrolytic capacitor is a typical choice.

## 11 Layout

### 11.1 Layout Guidelines

Layout is a critical portion of good power supply design. The following guidelines will help users design a PCB with the best power conversion performance, thermal performance, and minimized generation of unwanted EMI.

1. The input bypass capacitor  $C_{IN}$  must be placed as close as possible to the VIN and GND pins. Grounding for both the input and output capacitors should consist of localized top side planes that connect to the GND pin.
2. Minimize trace length to the FB pin net. Both feedback resistors,  $R_{FBT}$  and  $R_{FBB}$  should be located close to the FB pin. If  $V_{OUT}$  accuracy at the load is important, make sure  $V_{OUT}$  sense is made at the load. Route  $V_{OUT}$  sense path away from noisy nodes and preferably through a layer on the other side of a shielded layer.
3. Use ground plane in one of the middle layers as noise shielding and heat dissipation path if possible.
4. Make  $V_{IN}$ ,  $V_{OUT}$  and ground bus connections as wide as possible. This reduces any voltage drops on the input or output paths of the converter and maximizes efficiency.
5. Provide adequate device heat-sinking. GND, VIN and SW pins provide the main heat dissipation path, make the GND, VIN and SW plane area as large as possible. Use an array of heat-sinking vias to connect the top side ground plane to the ground plane on the bottom PCB layer. If the PCB has multiple copper layers, these thermal vias can also be connected to inner layer heat-spreading ground planes. Ensure enough copper area is used for heat-sinking to keep the junction temperature below 125 °C.

#### 11.1.1 Compact Layout for EMI Reduction

Radiated EMI is generated by the high di/dt components in pulsing currents in switching converters. The larger area covered by the path of a pulsing current, the more EMI is generated. High frequency ceramic bypass capacitors at the input side provide primary path for the high di/dt components of the pulsing current. Placing ceramic bypass capacitor(s) as close as possible to the VIN and GND pins is the key to EMI reduction.

The SW pin connecting to the inductor should be as short as possible, and just wide enough to carry the load current without excessive heating. Short, thick traces or copper pours (shapes) should be used for high current conduction path to minimize parasitic resistance. The output capacitors should be placed close to the  $V_{OUT}$  end of the inductor and closely grounded to GND pin.

#### 11.1.2 Feedback Resistors

To reduce noise sensitivity of the output voltage feedback path, it is important to place the resistor divider close to the FB pin, rather than close to the load. The FB pin is the input to the error amplifier, so it is a high impedance node and very sensitive to noise. Placing the resistor divider closer to the FB pin reduces the trace length of FB signal and reduces noise coupling. The output node is a low impedance node, so the trace from  $V_{OUT}$  to the resistor divider can be long if short path is not available.

If voltage accuracy at the load is important, make sure voltage sense is made at the load. Doing so will correct for voltage drops along the traces and provide the best output accuracy. The voltage sense trace from the load to the feedback resistor divider should be routed away from the SW node path and the inductor to avoid contaminating the feedback signal with switch noise, while also minimizing the trace length. This is most important when high value resistors are used to set the output voltage. It is recommended to route the voltage sense trace and place the resistor divider on a different layer than the inductor and SW node path, such that there is a ground plane in between the feedback trace and inductor/SW node polygon. This provides further shielding for the voltage feedback path from EMI noises.

## 11.2 Layout Example

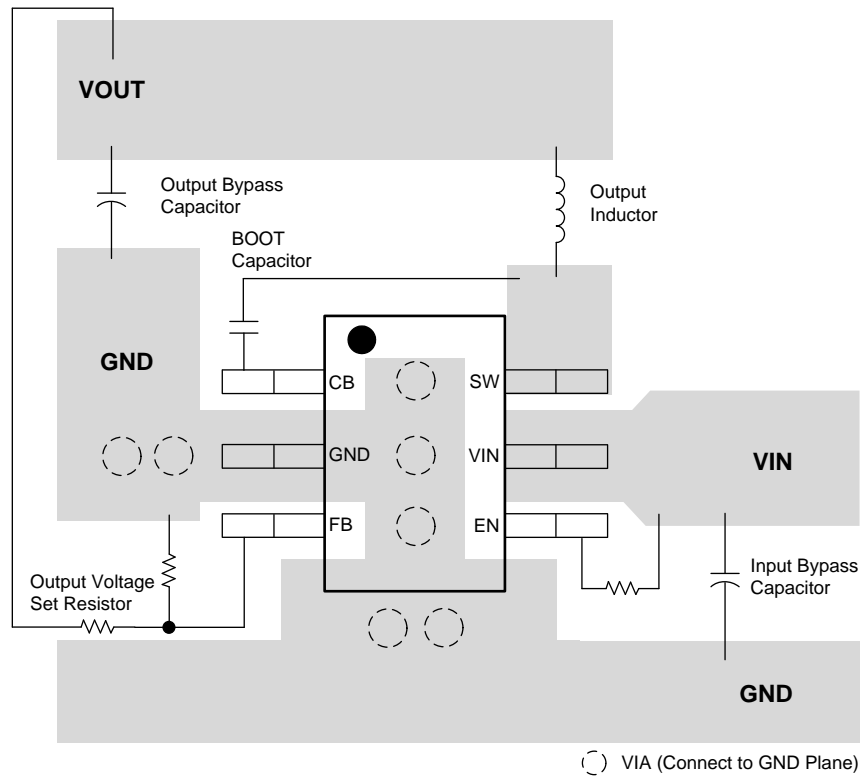

Figure 23. Layout

## 12 Device and Documentation Support

### 12.1 Device Support

#### 12.1.1 Development Support

##### 12.1.1.1 Custom Design With WEBENCH® Tools

Click [here](#) to create a custom design using the TPS560430-Q1 device with the WEBENCH® Power Designer.

1. Start by entering the input voltage ( $V_{IN}$ ), output voltage ( $V_{OUT}$ ), and output current ( $I_{OUT}$ ) requirements.
2. Optimize the design for key parameters such as efficiency, footprint, and cost using the optimizer dial.
3. Compare the generated design with other possible solutions from Texas Instruments.

The WEBENCH Power Designer provides a customized schematic along with a list of materials with real-time pricing and component availability.

In most cases, these actions are available:

- Run electrical simulations to see important waveforms and circuit performance
- Run thermal simulations to understand board thermal performance
- Export customized schematic and layout into popular CAD formats
- Print PDF reports for the design, and share the design with colleagues

Get more information about WEBENCH tools at [www.ti.com/WEBENCH](http://www.ti.com/WEBENCH).

### 12.2 Documentation Support

#### 12.2.1 Related Documentation

For related documentation see the following:

- [AN-1149 Layout Guidelines for Switching Power Supplies](#)

### 12.3 Receiving Notification of Documentation Updates

To receive notification of documentation updates, navigate to the device product folder on ti.com. In the upper right corner, click on *Alert me* to register and receive a weekly digest of any product information that has changed. For change details, review the revision history included in any revised document.

### 12.4 Community Resources

The following links connect to TI community resources. Linked contents are provided "AS IS" by the respective contributors. They do not constitute TI specifications and do not necessarily reflect TI's views; see TI's [Terms of Use](#).

**TI E2E™ Online Community** *TI's Engineer-to-Engineer (E2E) Community*. Created to foster collaboration among engineers. At [e2e.ti.com](http://e2e.ti.com), you can ask questions, share knowledge, explore ideas and help solve problems with fellow engineers.

**Design Support** *TI's Design Support* Quickly find helpful E2E forums along with design support tools and contact information for technical support.

### 12.5 Trademarks

E2E is a trademark of Texas Instruments.

SIMPLE SWITCHER, WEBENCH are registered trademarks of Texas Instruments.

### 12.6 Electrostatic Discharge Caution



This integrated circuit can be damaged by ESD. Texas Instruments recommends that all integrated circuits be handled with appropriate precautions. Failure to observe proper handling and installation procedures can cause damage.

ESD damage can range from subtle performance degradation to complete device failure. Precision integrated circuits may be more susceptible to damage because very small parametric changes could cause the device not to meet its published specifications.



## 12.7 Glossary

[SLYZ022](#) — *TI Glossary*.

This glossary lists and explains terms, acronyms, and definitions.

## 13 Mechanical, Packaging, and Orderable Information

The following pages include mechanical, packaging, and orderable information. This information is the most current data available for the designated devices. This data is subject to change without notice and revision of this document. For browser-based versions of this data sheet, refer to the left-hand navigation.

**PACKAGING INFORMATION**

Orderable Device	Status (1)	Package Type	Package Drawing	Pins	Package Qty	Eco Plan (2)	Lead finish/ Ball material (6)	MSL Peak Temp (3)	Op Temp (°C)	Device Marking (4/5)	Samples
TPS560430YFQDBVRQ1	ACTIVE	SOT-23	DBV	6	3000	RoHS & Green	NIPDAU	Level-1-260C-UNLIM	-40 to 125	1RTF	<a href="#">Samples</a>
TPS560430YQDBVRQ1	ACTIVE	SOT-23	DBV	6	3000	RoHS & Green	NIPDAU	Level-1-260C-UNLIM	-40 to 125	1RSF	<a href="#">Samples</a>

(1) The marketing status values are defined as follows:

**ACTIVE:** Product device recommended for new designs.

**LIFEBUY:** TI has announced that the device will be discontinued, and a lifetime-buy period is in effect.

**NRND:** Not recommended for new designs. Device is in production to support existing customers, but TI does not recommend using this part in a new design.

**PREVIEW:** Device has been announced but is not in production. Samples may or may not be available.

**OBSOLETE:** TI has discontinued the production of the device.

(2) **RoHS:** TI defines "RoHS" to mean semiconductor products that are compliant with the current EU RoHS requirements for all 10 RoHS substances, including the requirement that RoHS substance do not exceed 0.1% by weight in homogeneous materials. Where designed to be soldered at high temperatures, "RoHS" products are suitable for use in specified lead-free processes. TI may reference these types of products as "Pb-Free".

**RoHS Exempt:** TI defines "RoHS Exempt" to mean products that contain lead but are compliant with EU RoHS pursuant to a specific EU RoHS exemption.

**Green:** TI defines "Green" to mean the content of Chlorine (Cl) and Bromine (Br) based flame retardants meet JS709B low halogen requirements of <=1000ppm threshold. Antimony trioxide based flame retardants must also meet the <=1000ppm threshold requirement.

(3) MSL, Peak Temp. - The Moisture Sensitivity Level rating according to the JEDEC industry standard classifications, and peak solder temperature.

(4) There may be additional marking, which relates to the logo, the lot trace code information, or the environmental category on the device.

(5) Multiple Device Markings will be inside parentheses. Only one Device Marking contained in parentheses and separated by a "~" will appear on a device. If a line is indented then it is a continuation of the previous line and the two combined represent the entire Device Marking for that device.

(6) Lead finish/Ball material - Orderable Devices may have multiple material finish options. Finish options are separated by a vertical ruled line. Lead finish/Ball material values may wrap to two lines if the finish value exceeds the maximum column width.

**Important Information and Disclaimer:**The information provided on this page represents TI's knowledge and belief as of the date that it is provided. TI bases its knowledge and belief on information provided by third parties, and makes no representation or warranty as to the accuracy of such information. Efforts are underway to better integrate information from third parties. TI has taken and continues to take reasonable steps to provide representative and accurate information but may not have conducted destructive testing or chemical analysis on incoming materials and chemicals. TI and TI suppliers consider certain information to be proprietary, and thus CAS numbers and other limited information may not be available for release.

In no event shall TI's liability arising out of such information exceed the total purchase price of the TI part(s) at issue in this document sold by TI to Customer on an annual basis.

**OTHER QUALIFIED VERSIONS OF TPS560430-Q1 :**

- Catalog : [TPS560430](#)

## NOTE: Qualified Version Definitions:

- Catalog - TI's standard catalog product

**TAPE AND REEL INFORMATION**

**QUADRANT ASSIGNMENTS FOR PIN 1 ORIENTATION IN TAPE**

\*All dimensions are nominal

Device	Package Type	Package Drawing	Pins	SPQ	Reel Diameter (mm)	Reel Width W1 (mm)	A0 (mm)	B0 (mm)	K0 (mm)	P1 (mm)	W (mm)	Pin1 Quadrant
TPS560430YFQDBVRQ1	SOT-23	DBV	6	3000	180.0	8.4	3.2	3.2	1.4	4.0	8.0	Q3
TPS560430YQDBVRQ1	SOT-23	DBV	6	3000	180.0	8.4	3.2	3.2	1.4	4.0	8.0	Q3

**TAPE AND REEL BOX DIMENSIONS**

\*All dimensions are nominal

Device	Package Type	Package Drawing	Pins	SPQ	Length (mm)	Width (mm)	Height (mm)
TPS560430YFQDBVRQ1	SOT-23	DBV	6	3000	210.0	185.0	35.0
TPS560430YQDBVRQ1	SOT-23	DBV	6	3000	210.0	185.0	35.0



# EXAMPLE BOARD LAYOUT

DBV0006A

SOT-23 - 1.45 mm max height

SMALL OUTLINE TRANSISTOR



LAND PATTERN EXAMPLE  
EXPOSED METAL SHOWN  
SCALE:15X



SOLDER MASK DETAILS

4214840/F 05/2024

NOTES: (continued)

6. Publication IPC-7351 may have alternate designs.

7. Solder mask tolerances between and around signal pads can vary based on board fabrication site.

# EXAMPLE STENCIL DESIGN

DBV0006A

SOT-23 - 1.45 mm max height

SMALL OUTLINE TRANSISTOR



SOLDER PASTE EXAMPLE  
BASED ON 0.125 mm THICK STENCIL  
SCALE:15X

4214840/F 05/2024

NOTES: (continued)

8. Laser cutting apertures with trapezoidal walls and rounded corners may offer better paste release. IPC-7525 may have alternate design recommendations.
9. Board assembly site may have different recommendations for stencil design.



## IMPORTANT NOTICE AND DISCLAIMER

TI PROVIDES TECHNICAL AND RELIABILITY DATA (INCLUDING DATA SHEETS), DESIGN RESOURCES (INCLUDING REFERENCE DESIGNS), APPLICATION OR OTHER DESIGN ADVICE, WEB TOOLS, SAFETY INFORMATION, AND OTHER RESOURCES "AS IS" AND WITH ALL FAULTS, AND DISCLAIMS ALL WARRANTIES, EXPRESS AND IMPLIED, INCLUDING WITHOUT LIMITATION ANY IMPLIED WARRANTIES OF MERCHANTABILITY, FITNESS FOR A PARTICULAR PURPOSE OR NON-INFRINGEMENT OF THIRD PARTY INTELLECTUAL PROPERTY RIGHTS.

These resources are intended for skilled developers designing with TI products. You are solely responsible for (1) selecting the appropriate TI products for your application, (2) designing, validating and testing your application, and (3) ensuring your application meets applicable standards, and any other safety, security, regulatory or other requirements.

These resources are subject to change without notice. TI grants you permission to use these resources only for development of an application that uses the TI products described in the resource. Other reproduction and display of these resources is prohibited. No license is granted to any other TI intellectual property right or to any third party intellectual property right. TI disclaims responsibility for, and you will fully indemnify TI and its representatives against, any claims, damages, costs, losses, and liabilities arising out of your use of these resources.

TI's products are provided subject to [TI's Terms of Sale](#) or other applicable terms available either on [ti.com](https://www.ti.com) or provided in conjunction with such TI products. TI's provision of these resources does not expand or otherwise alter TI's applicable warranties or warranty disclaimers for TI products.

TI objects to and rejects any additional or different terms you may have proposed.

Mailing Address: Texas Instruments, Post Office Box 655303, Dallas, Texas 75265  
Copyright © 2024, Texas Instruments Incorporated