

DUR60120W

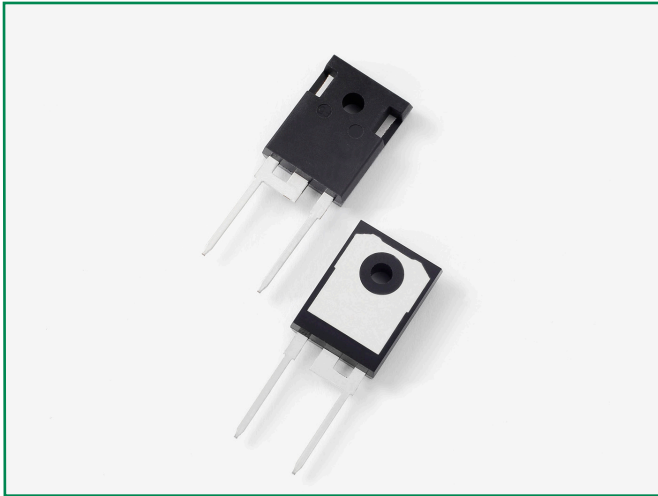

Description

Littelfuse DUR series Ultrafast Recovery Rectifier is designed to meet the general requirements of commercial applications by providing low T_{rr} , high-temperature, low-leakage and low forward voltage drop products. It is suitable for output rectifier, free-wheeling or boost diode in high-frequency power switching application such as switch mode power supply and DC-DC converters.

Features

- Ultra-fast switching
- Low reverse leakage current
- High surge current capability
- Low forward voltage drop
- Single die in two-lead TO-247AC package
- Pb-free E3 means 2nd level interconnect is Pb-free and the terminal finish material is tin(Sn) (IPC/JEDEC J-STD-609A.01)

Circuit Diagram

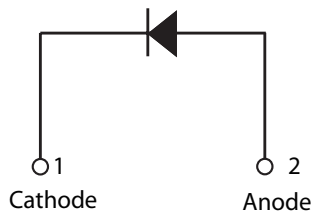

Applications

- Output rectifiers in switch mode power supplies (SMPS) and DC to DC converters
- Free-wheeling diode or boost diode in converters and motor control circuits
- Anti-parallel diode for high frequency switching devices such as IGBT
- Uninterruptible Power Supplies (UPS)
- Inductive heating and melting
- Ultrasonic cleaners and welders

Maximum Ratings

| Characteristics | Symbol | Conditions | Max. | Unit |
|---|-------------|---|------|------|
| Peak Inverse Voltage | V_{RWM} | - | 1200 | V |
| Average Rectifier Forward Current (Per Device) | $I_{F(AV)}$ | 50% duty cycle @ $T_c = 90^\circ\text{C}$, rectangular wave form | 60 | A |
| Peak One Cycle Non-Repetitive Surge Current (Per Leg) | I_{FSM} | 8.3 ms, half sine pulse | 280 | A |

Electrical Characteristics

| Characteristics | Symbol | Conditions | Typ. | Max. | Unit |
|---|-----------|---|------|------|---------------|
| Forward Voltage Drop (Per Leg) ¹ | V_{F1} | @60A, Pulse, $T_j = 25^\circ\text{C}$ | - | 3.5 | V |
| Reverse Current (Per Leg) ¹ | I_{R1} | @ $V_R = \text{Rated } V_R, T_j = 25^\circ\text{C}$ | 2.5 | 650 | μA |
| | I_{R2} | @ $V_R = \text{Rated } V_R, T_j = 125^\circ\text{C}$ | 1.4 | 8 | mA |
| Reverse Recovery Time (Per Leg) | t_{rr1} | $I_F = 500\text{mA}, I_R = 1\text{A}, \text{ and } I_{rm} = 250\text{mA}$ | - | 100 | ns |

Footnote ¹: Pulse Width < 300 μs , Duty Cycle < 2%

Thermal-Mechanical Specifications

| Characteristics | Symbol | Conditions | Specification | Unit |
|---|-----------------|--------------|---------------|------|
| Junction Temperature | T_J | - | -55 to +150 | °C |
| Storage Temperature | T_{stg} | - | -55 to +150 | °C |
| Typical Thermal Resistance Junction to Case | $R_{\theta JC}$ | DC operation | 0.65 | °C/W |
| Approximate Weight | wt | - | 6.7 | g |
| Case Style | - | TO-247AC | - | - |

Figure 1: Typical Forward Characteristics

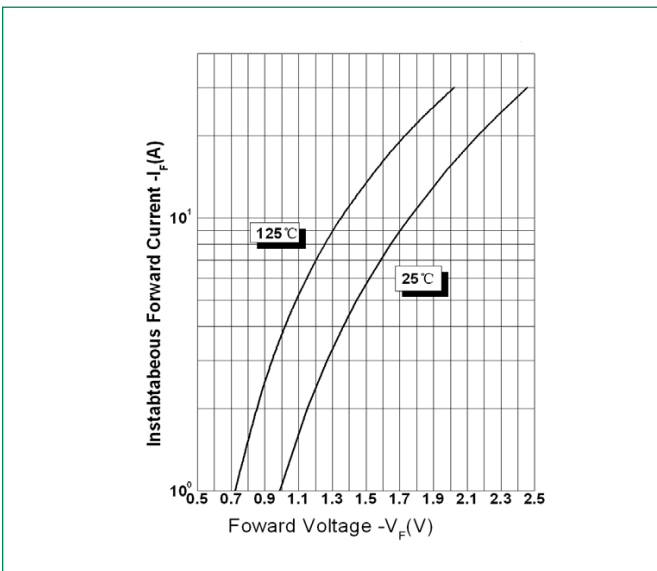

Figure 2: Typical Reverse Characteristics

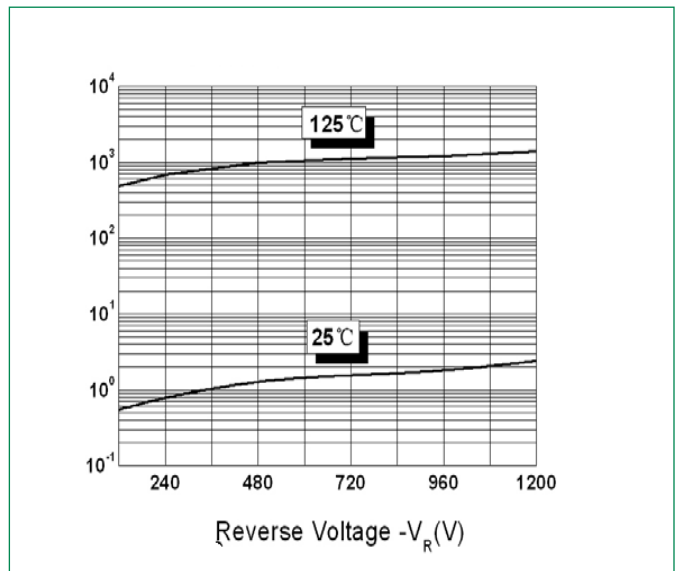
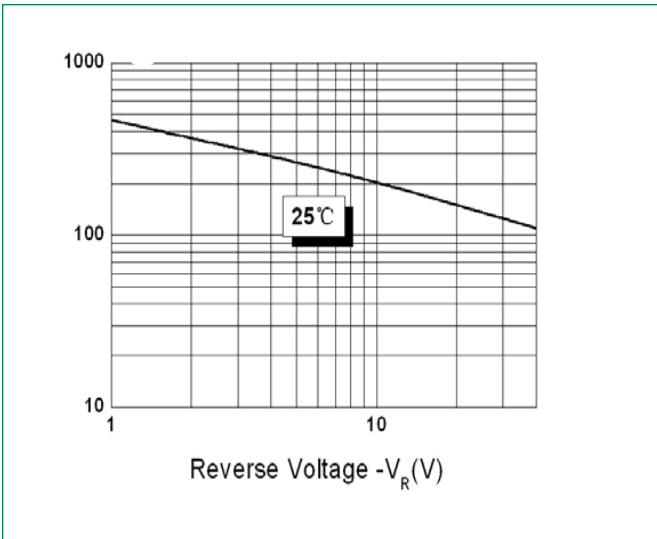
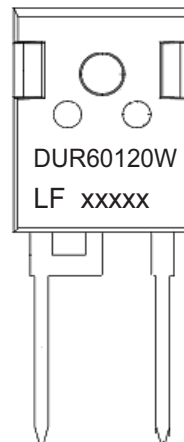

Figure 3: Typical Junction Capacitance



Part Numbering and Marking System



Where XXXXX is YYWWL

- DUR = Device Type
- 60 = Forward Current (60A)
- 120 = Reverse Voltage (1200V)
- W = Configuration
- LF = Littelfuse
- YY = Year
- WW = Week
- L = Lot Number

Ultrafast Recovery Rectifier

DUR60120W, 60A, 1200V, TO-247AC

Packing Options

| Part Number | Marking | Packing Mode | M.O.Q |
|-------------|-----------|--------------|-------|
| DUR60120W | DUR60120W | 30 pcs/Tube | 300 |

Dimensions-Package TO-247AC

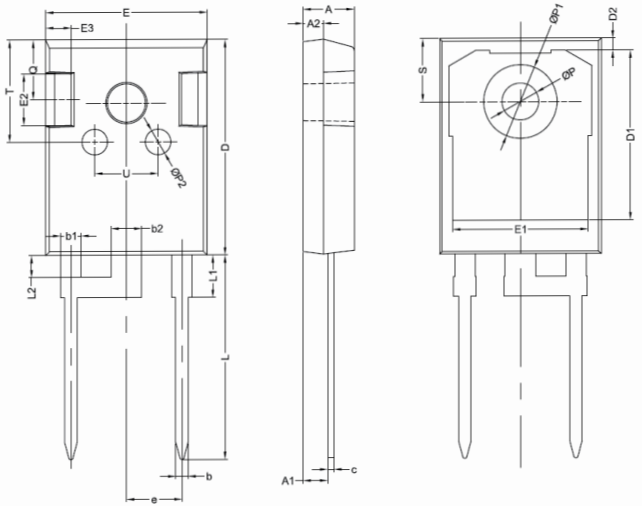

| Symbol | Millimeters | | |
|--------|-------------|-------|-------|
| | Min | Typ | Max |
| A | 4.80 | 5.00 | 5.20 |
| A1 | 2.21 | 2.41 | 2.61 |
| A2 | 1.90 | 2.00 | 2.10 |
| b | 1.10 | 1.20 | 1.35 |
| b1 | - | 2.00 | - |
| b2 | - | 3.00 | - |
| c | 0.55 | 0.60 | 0.75 |
| D | 20.80 | 21.00 | 21.20 |
| D1 | - | 16.55 | - |
| D2 | - | 1.20 | - |
| E | 15.60 | 15.80 | 16.00 |
| E1 | - | 13.30 | - |
| E2 | - | 5.00 | - |
| E3 | - | 2.50 | - |
| e | - | 5.44 | - |
| L | 19.42 | 19.92 | 20.42 |
| L1 | - | 4.13 | - |
| L2 | - | 2.15 | - |
| P | 3.50 | 3.60 | 3.70 |
| P1 | - | - | 7.40 |
| P2 | - | 2.50 | - |
| Q | - | 5.80 | - |
| S | 6.05 | 6.15 | 6.25 |
| T | - | 10.00 | - |
| U | - | 6.20 | - |

Tube Specification TO-247AC

