

Features

N-Ch:

- $V_{DS} (V) = 30V$
- $R_{DS(ON)} < 31m\Omega$ ($V_{GS} = 10V$)
- $R_{DS(ON)} < 48m\Omega$ ($V_{GS} = 4.5V$)

P-Ch:

- $V_{DS} (V) = -30V$
- $R_{DS(ON)} < 60m\Omega$ ($V_{GS} = -10V$)
- $R_{DS(ON)} < 100m\Omega$ ($V_{GS} = -4.5V$)
- Generation V Technology
- Ultra Low On-Resistance
- Dual N and P Channel MOSFET
- Surface Mount
- Fully Avalanche Rated
- Lead-Free

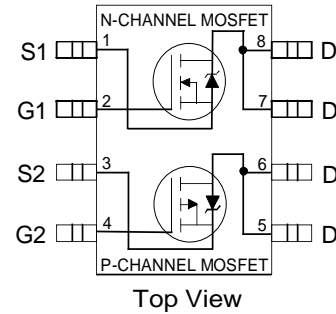

Description

The SOP-8 has been modified through a customized leadframe for enhanced thermal characteristics and multiple-die capability making it ideal in a variety of power applications. With these improvements, multiple devices can be used in an application with dramatically reduce board space. The package is designed for vapor phase, infra red, or wave soldering techniques.

Absolute Maximum Ratings ($T_A = 25^\circ C$ Unless Otherwise Noted)

| | Symbol | Maximum | | Units | |
|--|----------------|--------------------|-----------|-------|---|
| | | N-Channel | P-Channel | | |
| Drain-Source Voltage | V_{DS} | 30 | -30 | V | |
| Gate-Source Voltage | V_{GS} | ± 20 | | | |
| Continuous Drain Current ^⑤ | I_D | $T_A = 25^\circ C$ | 6.5 | -4.9 | A |
| | | $T_A = 70^\circ C$ | 5.2 | -3.9 | |
| Pulsed Drain Current | I_{DM} | 30 | -30 | | |
| Continuous Source Current (Diode Conduction) | I_S | 2.5 | -2.5 | | |
| Maximum Power Dissipation ^⑤ | P_D | $T_A = 25^\circ C$ | 2.0 | | W |
| | | $T_A = 70^\circ C$ | 1.3 | | |
| Single Pulse Avalanche Energy | E_{AS} | 82 | 140 | mJ | |
| Avalanche Current | I_{AR} | 4.0 | -2.8 | A | |
| Repetitive Avalanche Energy | E_{AR} | 0.20 | | mJ | |
| Peak Diode Recovery dv/dt ^② | dv/dt | 5.0 | -5.0 | V/ ns | |
| Junction and Storage Temperature Range | T_J, T_{STG} | -55 to + 150 °C | | | |

Thermal Resistance Ratings

| Parameter | Symbol | Limit | Units |
|--|-----------------|-------|--------------|
| Maximum Junction-to-Ambient ^⑤ | $R_{\theta JA}$ | 62.5 | $^\circ C/W$ |

Electrical Characteristics @ T_J = 25°C (unless otherwise specified)

| Parameter | Parameter | | Min. | Typ. | Max. | Units | Conditions |
|--|--------------------------------------|------|-------|------|------|-------|---|
| | | | | | | | |
| V _{(BR)DSS} | Drain-to-Source Breakdown Voltage | N-Ch | 30 | | | V | V _{GS} = 0V, I _D = 250μA |
| | | P-Ch | -30 | | | | V _{GS} = 0V, I _D = -250μA |
| ΔV _{(BR)DSS} /ΔT _J | Breakdown Voltage Temp. Coefficient | N-Ch | 0.022 | | | V/°C | Reference to 25°C, I _D = 1mA |
| | | P-Ch | 0.022 | | | | Reference to 25°C, I _D = -1mA |
| R _{DS(ON)} | Static Drain-to-Source On-Resistance | N-Ch | | 23 | 31 | mΩ | V _{GS} = 10V, I _D = 5.8A ④ |
| | | | | 32 | 48 | | V _{GS} = 4.5V, I _D = 4.7A ④ |
| | | P-Ch | | 42 | 60 | | V _{GS} = -10V, I _D = -4.9A ④ |
| | | | | 76 | 100 | | V _{GS} = -4.5V, I _D = -3.6A ④ |
| V _{GS(th)} | Gate Threshold Voltage | N-Ch | 1.0 | | | V | V _{DS} = V _{GS} , I _D = 250μA |
| | | P-Ch | -1.0 | | | | V _{DS} = V _{GS} , I _D = -250μA |
| g _{fs} | Forward Transconductance | N-Ch | | 14 | | S | V _{DS} = 15V, I _D = 5.8A ④ |
| | | P-Ch | | 7.7 | | | V _{DS} = -15V, I _D = -4.9A ④ |
| I _{DSS} | Drain-to-Source Leakage Current | N-Ch | | | 1.0 | μA | V _{DS} = 24V, V _{GS} = 0V |
| | | P-Ch | | | -1.0 | | V _{DS} = -24V, V _{GS} = 0V |
| | | N-Ch | | | 25 | | V _{DS} = 24V, V _{GS} = 0V, T _J = 55°C |
| | | P-Ch | | | -25 | | V _{DS} = -24V, V _{GS} = 0V, T _J = 55°C |
| I _{GSS} | Gate-to-Source Forward Leakage | N-P | | | ±100 | nA | V _{DS} = ±20V |
| Q _g | Total Gate Charge | N-Ch | | 22 | 33 | | N-Channel I _D = 5.8A, V _{DS} = 15V, V _{GS} = 10V ④ |
| | | P-Ch | | 23 | 34 | | |
| Q _{gs} | Gate-to-Source Charge | | | | | | |
| Q _{gd} | Gate-to-Drain ("Miller") Charge | | | | | | |
| t _{d(on)} | Turn-On Delay Time | N-Ch | | 8.1 | 12 | | N-Channel V _{DD} = 15V, I _D = 1.0A, R _G = 6.0Ω, R _D = 15Ω ④ |
| | | P-Ch | | 13 | 19 | | |
| t _r | Rise Time | N-Ch | | 8.9 | 13 | | P-Channel V _{DD} = -15V, I _D = -1.0A, R _G = 6.0Ω, R _D = 15Ω ④ |
| | | P-Ch | | 13 | 20 | | |
| t _{d(off)} | Turn-Off Delay Time | N-Ch | | 26 | 39 | | |
| | | P-Ch | | 34 | 51 | | |
| t _f | Fall Time | N-Ch | | 17 | 26 | | |
| | | P-Ch | | 32 | 48 | | |
| C _{iss} | Input Capacitance | N-Ch | | 650 | | | N-Channel V _{GS} = 0V, V _{DS} = 25V, f = 1.0MHz |
| | | P-Ch | | 710 | | | |
| C _{oss} | Output Capacitance | N-Ch | | 320 | | | P-Channel V _{GS} = 0V, V _{DS} = -25V, f = 1.0MHz |
| | | P-Ch | | 380 | | | |
| C _{rss} | Reverse Transfer Capacitance | N-Ch | | 130 | | | |
| | | P-Ch | | 180 | | | |

Source-Drain Ratings and Characteristics

| Parameter | Parameter | | Min. | Typ. | Max. | Units | Conditions |
|-----------------|--|------|-------|------|------|-------|---|
| I _S | Continuous Source Current (Body Diode) | N-Ch | | | 2.5 | A | |
| | | P-Ch | | | -2.5 | | |
| I _{SM} | Pulsed Source Current (Body Diode) ① | N-Ch | | | 30 | | |
| | | P-Ch | | | -30 | | |
| V _{SD} | Diode Forward Voltage | N-Ch | 0.78 | | 1.0 | V | T _J = 25°C, I _S = 1.7A, V _{GS} = 0V ③ |
| | | P-Ch | -0.78 | | -1.0 | | T _J = 25°C, I _S = -1.7A, V _{GS} = 0V ③ |
| t _{rr} | Reverse Recovery Time | N-Ch | | 45 | 68 | ns | N-Channel T _J = 25°C, I _F = 1.7A, di/dt = 100A/μs |
| | | P-Ch | | 44 | 66 | | |
| Q _{rr} | Reverse Recovery Charge | N-Ch | | 58 | 87 | nC | P-Channel T _J = 25°C, I _F = -1.7A, di/dt = 100A/μs ④ |
| | | P-Ch | | 42 | 63 | | |

Notes:

- ① Repetitive rating; pulse width limited by max. junction temperature. (See fig. 22)
- ② N-Channel I_{SD} ≤ 4.0A, di/dt ≤ 74A/μs, V_{DD} ≤ V_{(BR)DSS}, T_J ≤ 150°C
P-Channel I_{SD} ≤ -2.8A, di/dt ≤ 150A/μs, V_{DD} ≤ V_{(BR)DSS}, T_J ≤ 150°C
- ③ N-Channel Starting T_J = 25°C, L = 10mH R_G = 25Ω, I_{AS} = 4.0A. (See Figure 12)
P-Channel Starting T_J = 25°C, L = 35mH R_G = 25Ω, I_{AS} = -2.8A.
- ④ Pulse width ≤ 300μs; duty cycle ≤ 2%.
- ⑤ Surface mounted on FR-4 board, t ≤ 10sec.

N-Channel

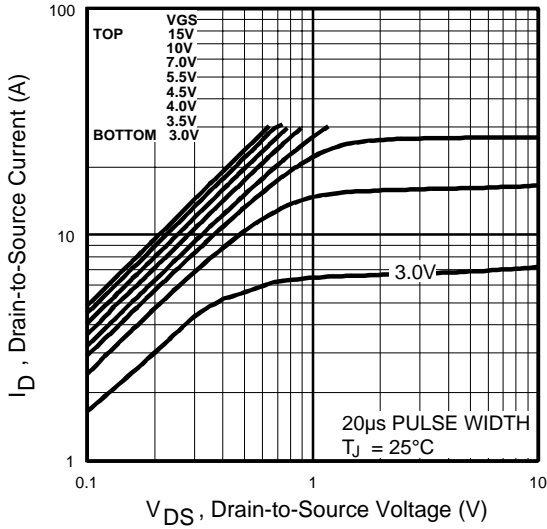

Fig 1. Typical Output Characteristics

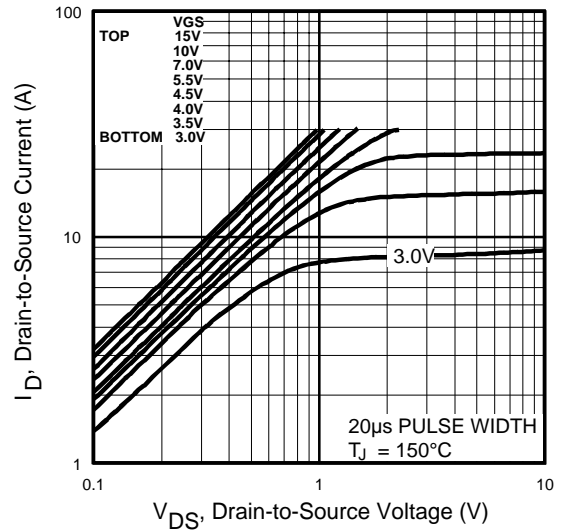

Fig 2. Typical Output Characteristics

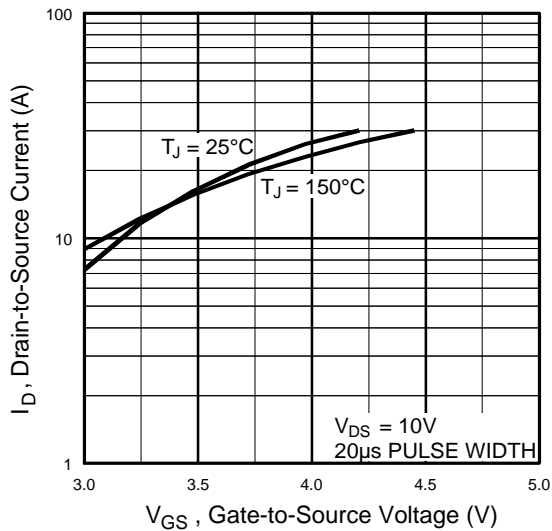

Fig 3. Typical Transfer Characteristics

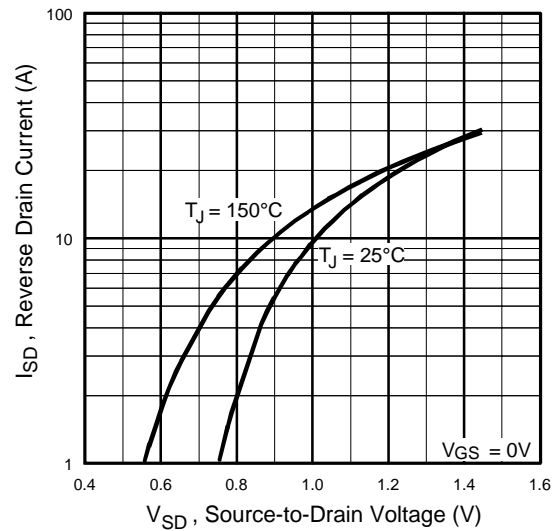

Fig 4. Typical Source-Drain Diode Forward Voltage

N-Channel

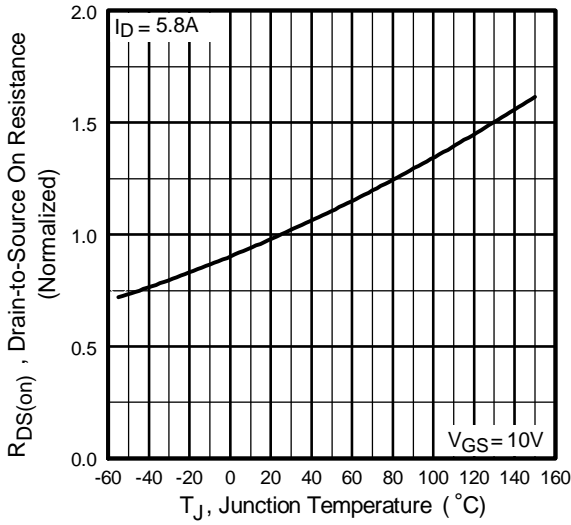

Fig 5. Normalized On-Resistance Vs. Temperature

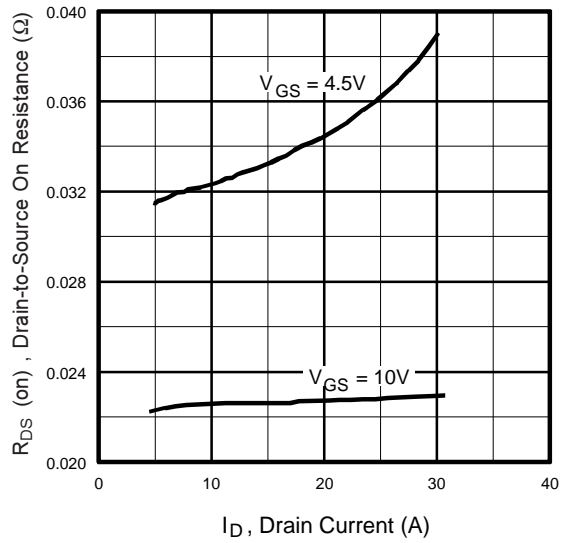

Fig 6. Typical On-Resistance Vs. Drain Current

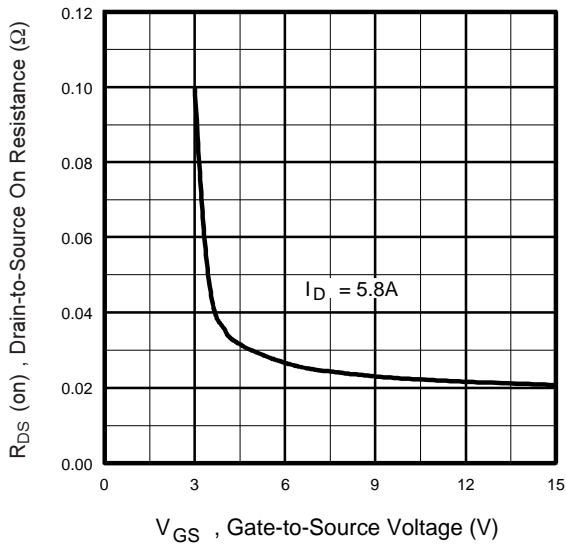

Fig 7. Typical On-Resistance Vs. Gate Voltage

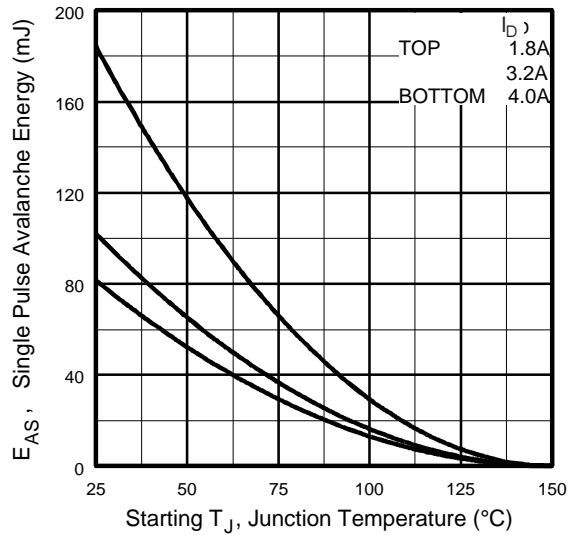

Fig 8. Maximum Avalanche Energy Vs. Drain Current

N-Channel

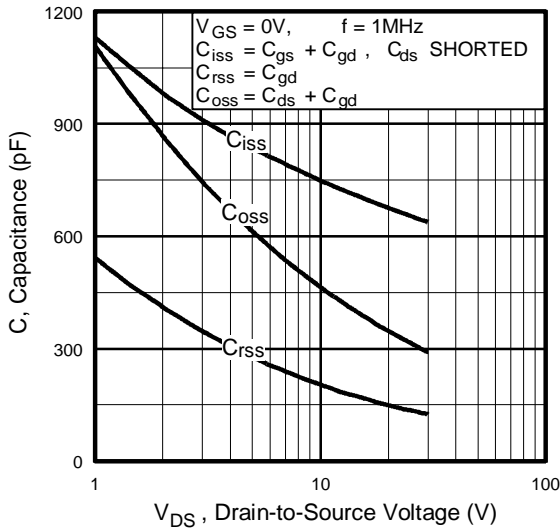

Fig 9. Typical Capacitance Vs. Drain-to-Source Voltage

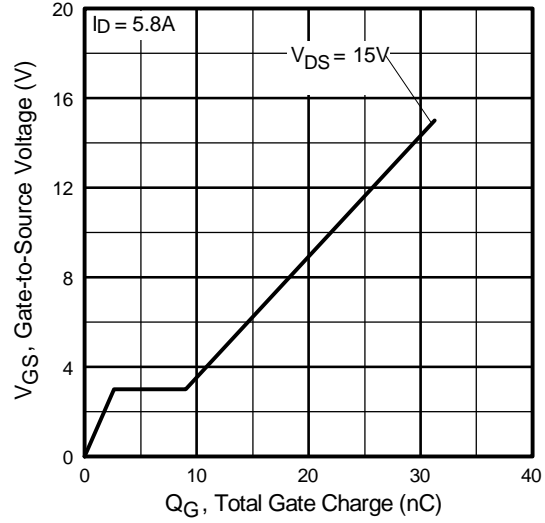

Fig 10. Typical Gate Charge Vs. Gate-to-Source Voltage

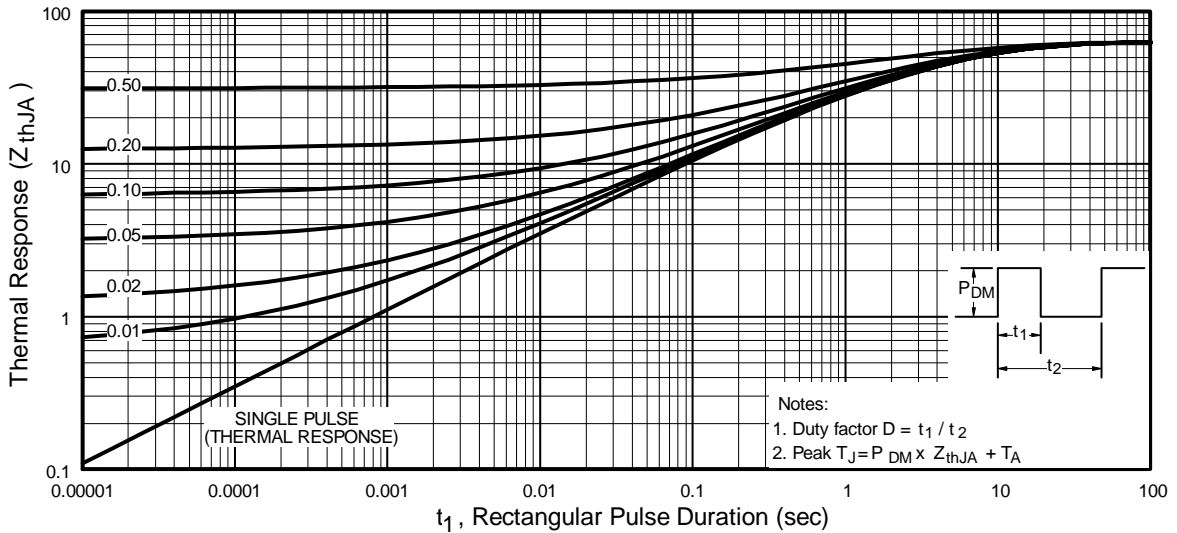

Fig 11. Maximum Effective Transient Thermal Impedance, Junction-to-Ambient

P-Channel

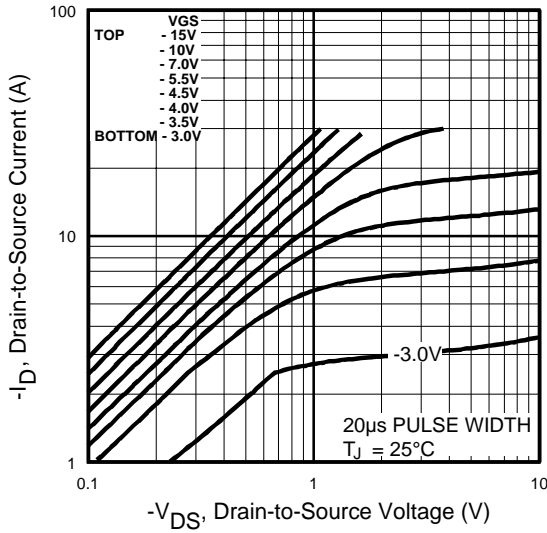

Fig 12. Typical Output Characteristics

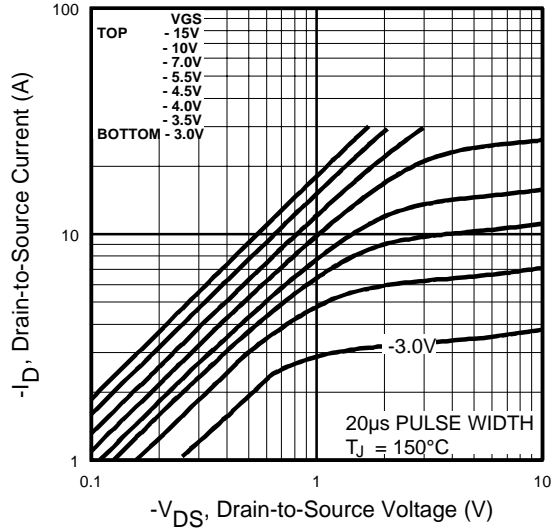

Fig 13. Typical Output Characteristics

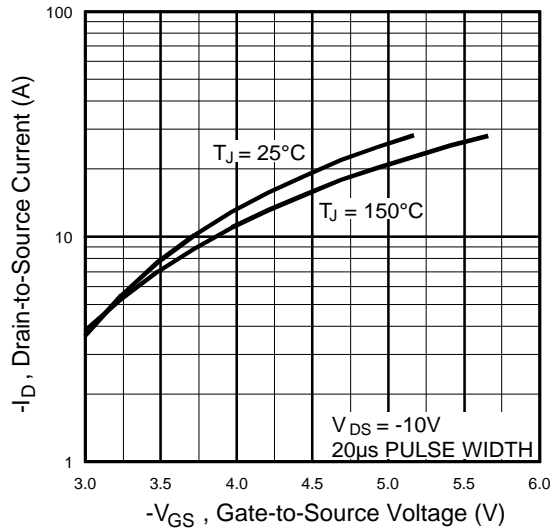

Fig 14. Typical Transfer Characteristics

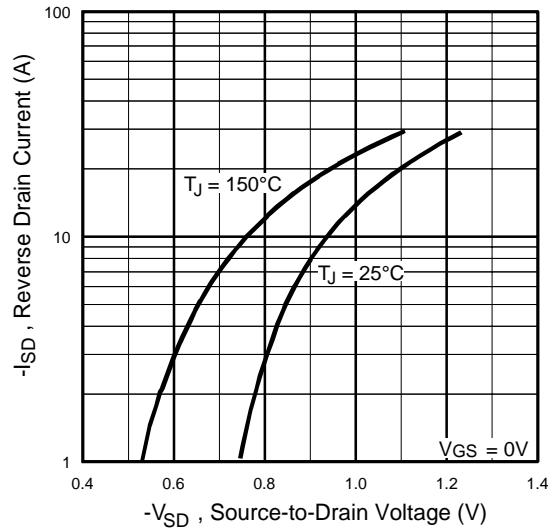

Fig 15. Typical Source-Drain Diode Forward Voltage

P-Channel

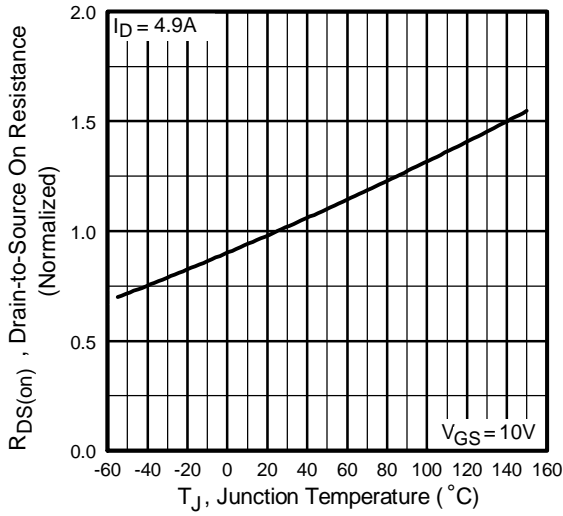

Fig 16. Normalized On-Resistance Vs. Temperature

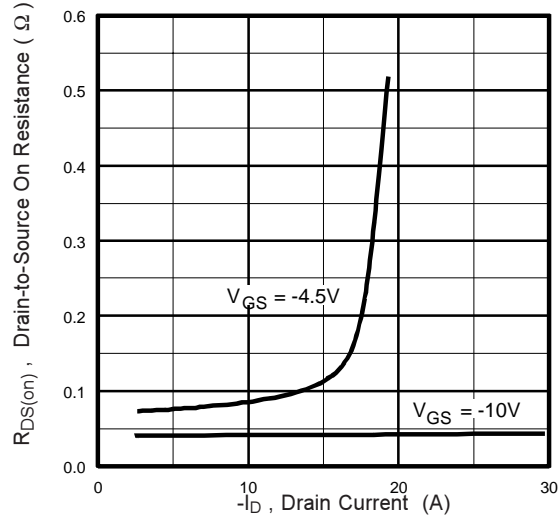

Fig 17. Typical On-Resistance Vs. Drain Current

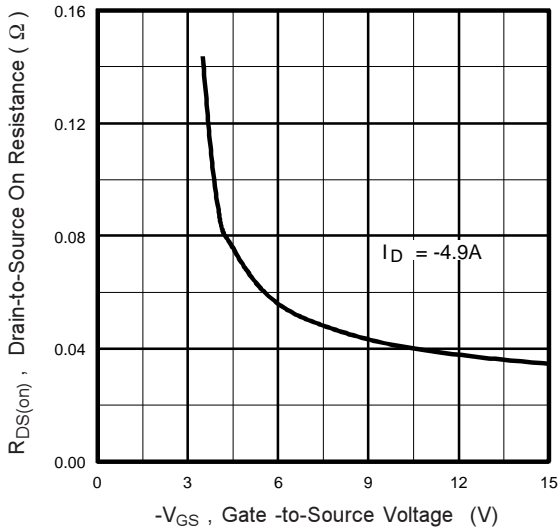

Fig 18. Typical On-Resistance Vs. Gate Voltage

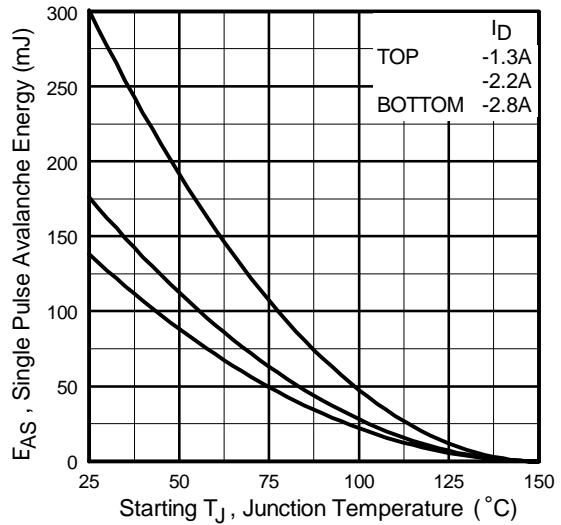

Fig 19. Maximum Avalanche Energy Vs. Drain Current

P-Channel

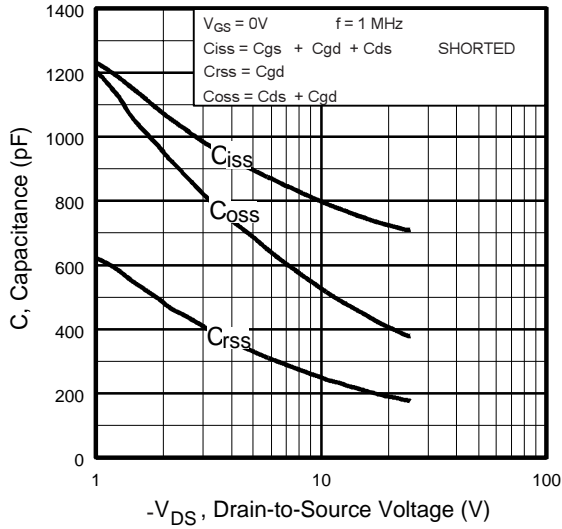

Fig 20. Typical Capacitance Vs. Drain-to-Source Voltage

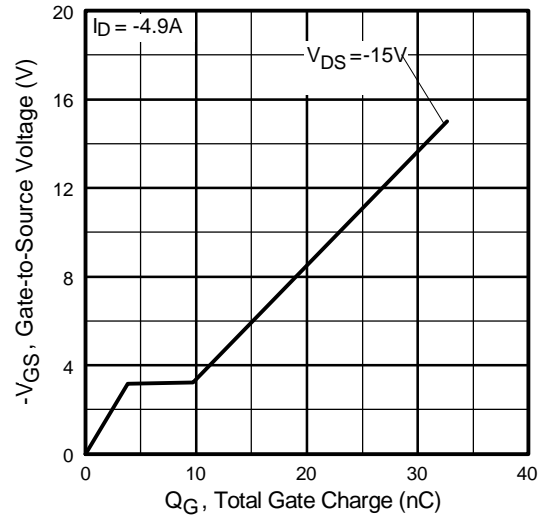

Fig 21. Typical Gate Charge Vs. Gate-to-Source Voltage

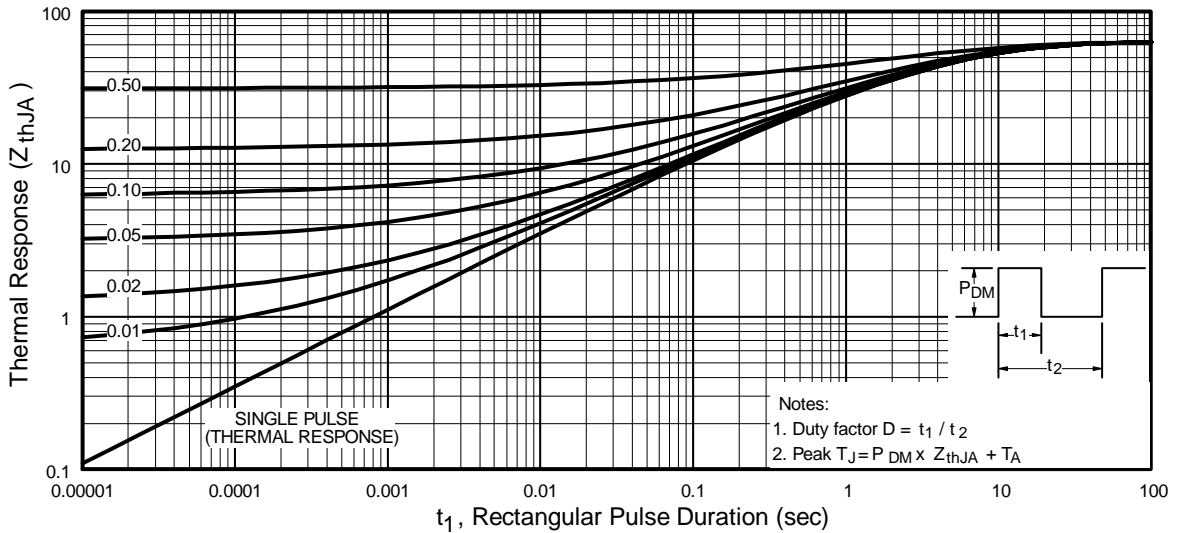
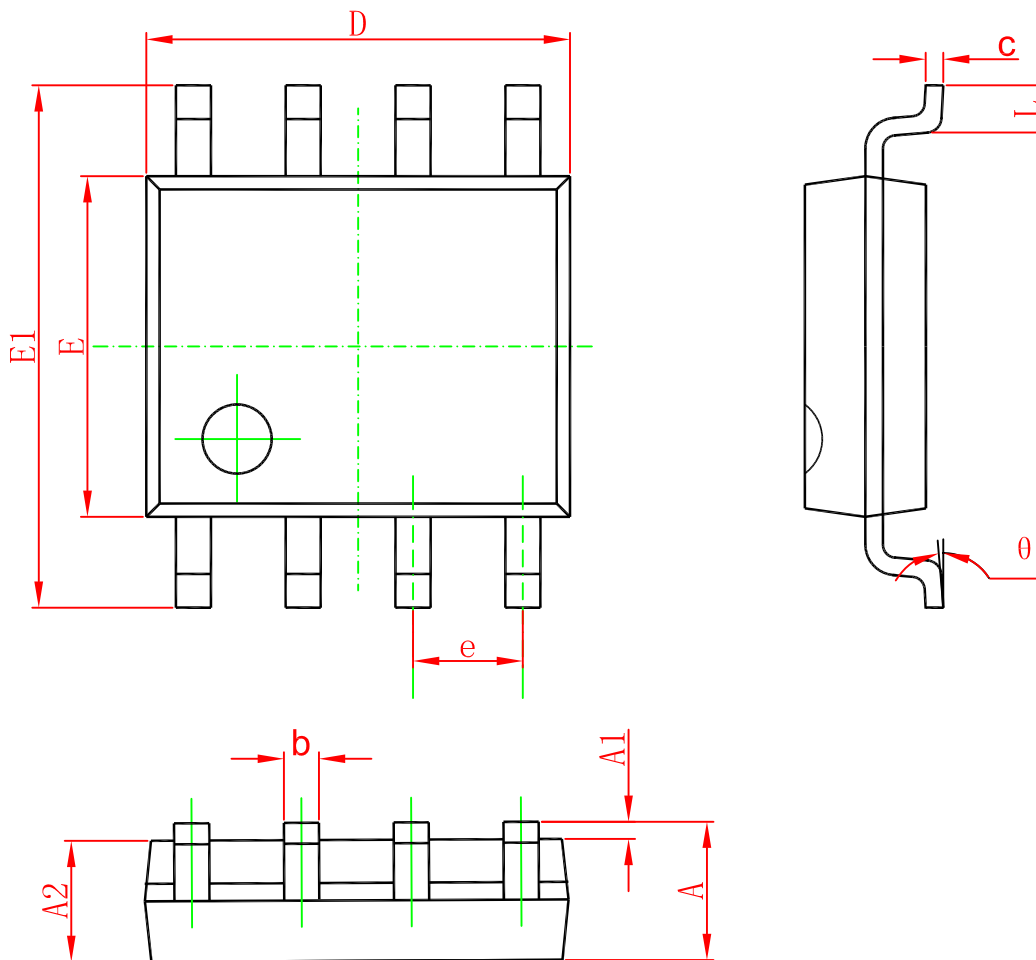

Fig 22. Maximum Effective Transient Thermal Impedance, Junction-to-Ambient

SOP-8



| Symbol | Dimensions In Millimeters | | Dimensions In Inches | |
|--------|---------------------------|-------|----------------------|-------|
| | Min | Max | Min | Max |
| A | 1.350 | 1.750 | 0.053 | 0.069 |
| A1 | 0.100 | 0.250 | 0.004 | 0.010 |
| A2 | 1.350 | 1.550 | 0.053 | 0.061 |
| b | 0.330 | 0.510 | 0.013 | 0.020 |
| c | 0.170 | 0.250 | 0.006 | 0.010 |
| D | 4.700 | 5.100 | 0.185 | 0.200 |
| E | 3.800 | 4.000 | 0.150 | 0.157 |
| E1 | 5.800 | 6.200 | 0.228 | 0.244 |
| e | 1.270(BSC) | | 0.050(BSC) | |
| L | 0.400 | 1.270 | 0.016 | 0.050 |
| θ | 0° | 8° | 0° | 8° |

Marking

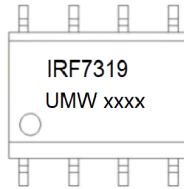

Ordering information

| Order code | Package | Baseqty | Deliverymode |
|---------------|---------|---------|---------------|
| UMW IRF7319TR | SOP-8 | 3000 | Tape and reel |