

3.3 V/5 V ECL ÷ 4 Divider

MC10EP33, MC100EP33

Description

The MC10/100EP33 is an integrated ÷ 4 divider. The differential clock inputs.

The V_{BB} pin, an internally generated voltage supply, is available to this device only. For single-ended input conditions, the unused differential input is connected to V_{BB} as a switching reference voltage. V_{BB} may also rebias AC coupled inputs. When used, decouple V_{BB} and V_{CC} via a 0.01 μ F capacitor and limit current sourcing or sinking to 0.5 mA. When not used, V_{BB} should be left open.

The reset pin is asynchronous and is asserted on the rising edge. Upon powerup, the internal flip-flops will attain a random state; the reset allows for the synchronization of multiple EP33's in a system.

The 100 Series contains temperature compensation.

Features

- 320 ps Propagation Delay
- Maximum Frequency = > 4 GHz Typical
- PECL Mode Operating Range:
 $V_{CC} = 3.0 \text{ V to } 5.5 \text{ V}$ with $V_{EE} = 0 \text{ V}$
- NECL Mode Operating Range:
 $V_{CC} = 0 \text{ V}$ with $V_{EE} = -3.0 \text{ V to } -5.5 \text{ V}$
- Open Input Default State
- Safety Clamp on Inputs
- Q Output Will Default LOW with Inputs Open or at V_{EE}
- V_{BB} Output
- These Devices are Pb-Free, Halogen Free and are RoHS Compliant



ON Semiconductor®

www.onsemi.com



SOIC-8 NB
D SUFFIX
CASE 751-07



TSSOP-8
DT SUFFIX
CASE 948R-02

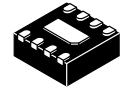

DFN8
MN SUFFIX
CASE 506AA

MARKING DIAGRAMS*

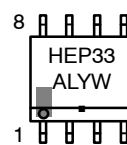

SOIC-8 NB

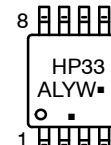

TSSOP-8

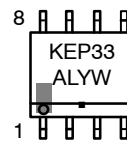

SOIC-8 NB

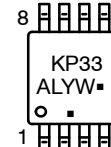

TSSOP-8

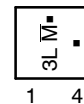

DFN8

H = MC10
A = Assembly Location
K = MC100
L = Wafer Lot
Y = Year
W = Work Week
3L = MC100
M̄ = Date Code
▪ = Pb-Free Package
(Note: Microdot may be in either location)

*For additional marking information, refer to Application Note [AND8002/D](#).

ORDERING INFORMATION

See detailed ordering and shipping information in the package dimensions section on page 8 of this data sheet.

MC10EP33, MC100EP33

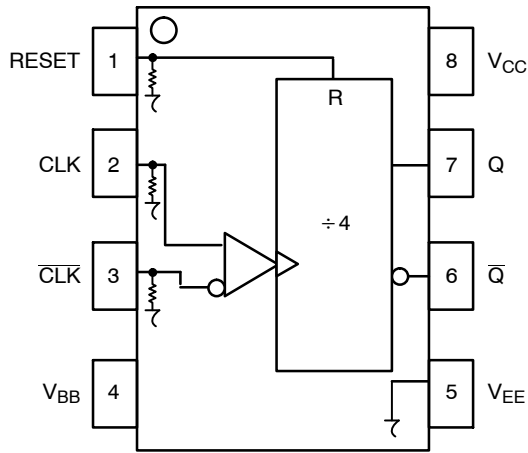

Figure 1. 8-Lead Pinout (Top View) and Logic Diagram

Table 1. PIN DESCRIPTION

PIN	FUNCTION
CLK*, $\overline{\text{CLK}}^*$	ECL Clock Inputs
Reset*	ECL Asynchronous Reset
V _{BB}	Reference Voltage Output
Q, $\overline{\text{Q}}$	ECL Data Outputs
V _{CC}	Positive Supply
V _{EE}	Negative Supply
EP	(DFN8 only) Thermal exposed pad must be connected to a sufficient thermal conduit. Electrically connect to the most negative supply (GND) or leave unconnected, floating open.

* Pins will default LOW when left open.

Table 2. TRUTH TABLE

CLK	$\overline{\text{CLK}}$	RESET	Q	$\overline{\text{Q}}$
X	X	Z	L	H
Z	Z	L	F	F

Z = LOW to HIGH Transition

$\overline{\text{Z}}$ = HIGH to LOW Transition

F = Divide by 4 Function

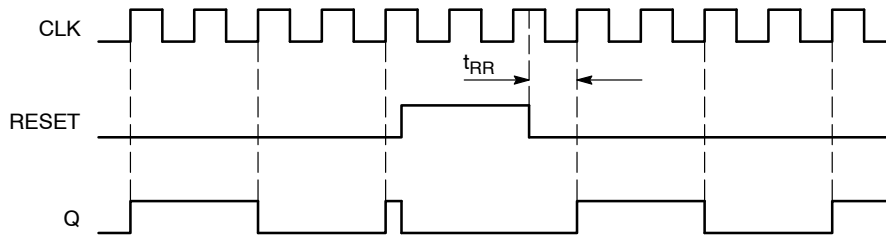

Figure 2. Timing Diagram

Table 3. ATTRIBUTES

Characteristics	Value
Internal Input Pulldown Resistor	75 k Ω
Internal Input Pullup Resistor	NA
ESD Protection Human Body Model Machine Model Charged Device Model	> 4 kV > 200 V > 2 kV
Moisture Sensitivity, Indefinite Time Out of Drypack (Note 1)	Pb-Free Pkg
SOIC-8 NB TSSOP-8 DFN8	Level 1 Level 3 Level 1
Flammability Rating Oxygen Index: 28 to 34	UL-94 V-0 @ 0.125 in
Transistor Count	91 Devices
Meets or exceeds JEDEC Spec EIA/JESD78 IC Latchup Test	

1. For additional information, see Application Note [AND8003/D](#).

MC10EP33, MC100EP33

Table 4. MAXIMUM RATINGS

Symbol	Parameter	Condition 1	Condition 2	Rating	Unit
V _{CC}	PECL Mode Power Supply	V _{EE} = 0 V		6	V
V _{EE}	NECL Mode Power Supply	V _{CC} = 0 V		-6	V
V _I	PECL Mode Input Voltage NECL Mode Input Voltage	V _{EE} = 0 V V _{CC} = 0 V	V _I ≤ V _{CC} V _I ≥ V _{EE}	6 -6	V
I _{out}	Output Current	Continuous Surge		50 100	mA
I _{BB}	V _{BB} Sink/Source			±0.5	mA
T _A	Operating Temperature Range			-40 to +85	°C
T _{stg}	Storage Temperature Range			-65 to +150	°C
θ _{JA}	Thermal Resistance (Junction-to-Ambient)	0 lfpm 500 lfpm	SOIC-8 NB SOIC-8 NB	190 130	°C/W
θ _{JC}	Thermal Resistance (Junction-to-Case)	Standard Board	SOIC-8 NB	41 to 44	°C/W
θ _{JA}	Thermal Resistance (Junction-to-Ambient)	0 lfpm 500 lfpm	TSSOP-8 TSSOP-8	185 140	°C/W
θ _{JC}	Thermal Resistance (Junction-to-Case)	Standard Board	TSSOP-8	41 to 44	°C/W
T _{sol}	Wave Solder	< 2 to 3 sec @ 248°C		265	°C
θ _{JA}	Thermal Resistance (Junction-to-Ambient)	0 lfpm 500 lfpm	DFN8 DFN8	129 84	°C/W
θ _{JC}	Thermal Resistance (Junction-to-Case)	(Note 2)	DFN8	35 to 40	°C/W
T _{sol}	Wave Solder (Pb-Free)	< 2 to 3 sec @ 260°C		265	°C

Stresses exceeding those listed in the Maximum Ratings table may damage the device. If any of these limits are exceeded, device functionality should not be assumed, damage may occur and reliability may be affected.

2. JEDEC standard multilayer board – 2S2P (2 signal, 2 power).

Table 5. 10EP DC CHARACTERISTICS, PECL (V_{CC} = 3.3 V, V_{EE} = 0 V (Note 1))

Symbol	Characteristic	-40°C			25°C			85°C			Unit
		Min	Typ	Max	Min	Typ	Max	Min	Typ	Max	
I _{EE}	Power Supply Current	18	26	40	18	26	40	18	26	40	mA
V _{OH}	Output HIGH Voltage (Note 2)	2165	2290	2415	2230	2355	2480	2290	2415	2540	mV
V _{OL}	Output LOW Voltage (Note 2)	1365	1490	1615	1430	1555	1680	1490	1615	1740	mV
V _{IH}	Input HIGH Voltage (Single-Ended)	2090		2415	2155		2480	2215		2540	mV
V _{IL}	Input LOW Voltage (Single-Ended)	1365		1690	1430		1755	1490		1815	mV
V _{BB}	Output Voltage Reference	1790	1890	1990	1855	1955	2055	1915	2015	2115	mV
V _{IHCMR}	Input HIGH Voltage Common Mode Range (Differential Configuration) (Note 3)	2.0		3.3	2.0		3.3	2.0		3.3	V
I _{IH}	Input HIGH Current			150			150			150	μA
I _{IL}	Input LOW Current	0.5			0.5			0.5			μA

NOTE: Device will meet the specifications after thermal equilibrium has been established when mounted in a test socket or printed circuit board with maintained transverse airflow greater than 500 lfpm.

- Input and output parameters vary 1:1 with V_{CC}. V_{EE} can vary +0.3 V to -2.2 V.
- All loading with 50 Ω to V_{CC} - 2.0 V.
- V_{IHCMR} min varies 1:1 with V_{EE}. V_{IHCMR} max varies 1:1 with V_{CC}. The V_{IHCMR} range is referenced to the most positive side of the differential input signal.

MC10EP33, MC100EP33

Table 6. 10EP DC CHARACTERISTICS, PECL ($V_{CC} = 5.0\text{ V}$, $V_{EE} = 0\text{ V}$ (Note 1))

Symbol	Characteristic	-40°C			25°C			85°C			Unit
		Min	Typ	Max	Min	Typ	Max	Min	Typ	Max	
I_{EE}	Power Supply Current	18	26	40	18	26	40	18	26	40	mA
V_{OH}	Output HIGH Voltage (Note 2)	3865	3990	4115	3930	4055	4180	3990	4115	4240	mV
V_{OL}	Output LOW Voltage (Note 2)	3065	3190	3315	3130	3255	3380	3190	3315	3440	mV
V_{IH}	Input HIGH Voltage (Single-Ended)	3790		4115	3855		4180	3915		4240	mV
V_{IL}	Input LOW Voltage (Single-Ended)	3065		3390	3130		3455	3190		3515	mV
V_{BB}	Output Voltage Reference	3490	3590	3690	3555	3655	3755	3615	3715	3815	mV
V_{IHCMR}	Input HIGH Voltage Common Mode Range (Differential Configuration) (Note 3)	2.0		5.0	2.0		5.0	2.0		5.0	V
I_{IH}	Input HIGH Current			150			150			150	μA
I_{IL}	Input LOW Current	0.5			0.5			0.5			μA

NOTE: Device will meet the specifications after thermal equilibrium has been established when mounted in a test socket or printed circuit board with maintained transverse airflow greater than 500 lpm.

1. Input and output parameters vary 1:1 with V_{CC} . V_{EE} can vary +2.0 V to -0.5 V.
2. All loading with $50\ \Omega$ to $V_{CC} - 2.0\text{ V}$.
3. V_{IHCMR} min varies 1:1 with V_{EE} . V_{IHCMR} max varies 1:1 with V_{CC} . The V_{IHCMR} range is referenced to the most positive side of the differential input signal.

Table 7. 10EP DC CHARACTERISTICS, NECL ($V_{CC} = 0\text{ V}$; $V_{EE} = -5.5\text{ V}$ to -3.0 V (Note 1))

Symbol	Characteristic	-40°C			25°C			85°C			Unit
		Min	Typ	Max	Min	Typ	Max	Min	Typ	Max	
I_{EE}	Power Supply Current	18	26	40	18	26	40	18	26	40	mA
V_{OH}	Output HIGH Voltage (Note 2)	-1135	-1010	-885	-1070	-945	-820	-1010	-885	-760	mV
V_{OL}	Output LOW Voltage (Note 2)	-1935	-1810	-1685	-1870	-1745	-1620	-1810	-1685	-1560	mV
V_{IH}	Input HIGH Voltage (Single-Ended)	-1210		-885	-1145		-820	-1085		-760	mV
V_{IL}	Input LOW Voltage (Single-Ended)	-1935		-1610	-1870		-1545	-1810		-1485	mV
V_{BB}	Output Voltage Reference	-1510	-1410	-1310	-1445	-1345	-1245	-1385	-1285	-1185	mV
V_{IHCMR}	Input HIGH Voltage Common Mode Range (Differential Configuration) (Note 3)	$V_{EE}+2.0$		0.0	$V_{EE}+2.0$		0.0	$V_{EE}+2.0$		0.0	V
I_{IH}	Input HIGH Current			150			150			150	μA
I_{IL}	Input LOW Current	0.5			0.5			0.5			μA

NOTE: Device will meet the specifications after thermal equilibrium has been established when mounted in a test socket or printed circuit board with maintained transverse airflow greater than 500 lpm.

1. Input and output parameters vary 1:1 with V_{CC} .
2. All loading with $50\ \Omega$ to $V_{CC} - 2.0\text{ V}$.
3. V_{IHCMR} min varies 1:1 with V_{EE} . V_{IHCMR} max varies 1:1 with V_{CC} . The V_{IHCMR} range is referenced to the most positive side of the differential input signal.

MC10EP33, MC100EP33

Table 8. 100EP DC CHARACTERISTICS, PECL ($V_{CC} = 3.3\text{ V}$, $V_{EE} = 0\text{ V}$ (Note 1))

Symbol	Characteristic	-40°C			25°C			85°C			Unit
		Min	Typ	Max	Min	Typ	Max	Min	Typ	Max	
I_{EE}	Power Supply Current	18	26	40	23	26	45	23	26	45	mA
V_{OH}	Output HIGH Voltage (Note 2)	2155	2280	2405	2155	2280	2405	2155	2280	2405	mV
V_{OL}	Output LOW Voltage (Note 2)	1355	1480	1605	1355	1480	1605	1355	1480	1605	mV
V_{IH}	Input HIGH Voltage (Single-Ended)	2075		2420	2075		2420	2075		2420	mV
V_{IL}	Input LOW Voltage (Single-Ended)	1355		1675	1355		1675	1355		1675	mV
V_{BB}	Output Voltage Reference	1775	1875	1975	1775	1875	1975	1775	1875	1975	mV
V_{IHCMR}	Input HIGH Voltage Common Mode Range (Differential Configuration) (Note 3)	2.0		3.3	2.0		3.3	2.0		3.3	V
I_{IH}	Input HIGH Current			150			150			150	μA
I_{IL}	Input LOW Current	0.5			0.5			0.5			μA

NOTE: Device will meet the specifications after thermal equilibrium has been established when mounted in a test socket or printed circuit board with maintained transverse airflow greater than 500 lfm.

1. Input and output parameters vary 1:1 with V_{CC} . V_{EE} can vary +0.3 V to -2.2 V.
2. All loading with $50\ \Omega$ to $V_{CC} - 2.0\text{ V}$.
3. V_{IHCMR} min varies 1:1 with V_{EE} . V_{IHCMR} max varies 1:1 with V_{CC} . The V_{IHCMR} range is referenced to the most positive side of the differential input signal.

Table 9. 100EP DC CHARACTERISTICS, PECL ($V_{CC} = 5.0\text{ V}$, $V_{EE} = 0\text{ V}$ (Note 1))

Symbol	Characteristic	-40°C			25°C			85°C			Unit
		Min	Typ	Max	Min	Typ	Max	Min	Typ	Max	
I_{EE}	Power Supply Current	18	26	40	23	26	45	23	26	45	mA
V_{OH}	Output HIGH Voltage (Note 2)	3855	3980	4105	3855	3980	4105	3855	3980	4105	mV
V_{OL}	Output LOW Voltage (Note 2)	3055	3180	3305	3055	3180	3305	3055	3180	3305	mV
V_{IH}	Input HIGH Voltage (Single-Ended)	3775		4120	3775		4120	3775		4120	mV
V_{IL}	Input LOW Voltage (Single-Ended)	3055		3375	3055		3375	3055		3375	mV
V_{BB}	Output Voltage Reference	3475	3575	3675	3475	3575	3675	3475	3575	3675	mV
V_{IHCMR}	Input HIGH Voltage Common Mode Range (Differential Configuration) (Note 3)	2.0		5.0	2.0		5.0	2.0		5.0	V
I_{IH}	Input HIGH Current			150			150			150	μA
I_{IL}	Input LOW Current	0.5			0.5			0.5			μA

NOTE: Device will meet the specifications after thermal equilibrium has been established when mounted in a test socket or printed circuit board with maintained transverse airflow greater than 500 lfm.

1. Input and output parameters vary 1:1 with V_{CC} . V_{EE} can vary +2.0 V to -0.5 V.
2. All loading with $50\ \Omega$ to $V_{CC} - 2.0\text{ V}$.
3. V_{IHCMR} min varies 1:1 with V_{EE} . V_{IHCMR} max varies 1:1 with V_{CC} . The V_{IHCMR} range is referenced to the most positive side of the differential input signal.

MC10EP33, MC100EP33

Table 10. 100EP DC CHARACTERISTICS, NECL ($V_{CC} = 0\text{ V}$; $V_{EE} = -5.5\text{ V}$ to -3.0 V (Note 1))

Symbol	Characteristic	-40°C			25°C			85°C			Unit
		Min	Typ	Max	Min	Typ	Max	Min	Typ	Max	
I_{EE}	Power Supply Current	18	26	40	23	26	45	23	26	45	mA
V_{OH}	Output HIGH Voltage (Note 2)	-1145	-1020	-895	-1145	-1020	-895	-1145	-1020	-895	mV
V_{OL}	Output LOW Voltage (Note 2)	-1945	-1820	-1695	-1945	-1820	-1695	-1945	-1820	-1695	mV
V_{IH}	Input HIGH Voltage (Single-Ended)	-1225		-880	-1225		-880	-1225		-880	mV
V_{IL}	Input LOW Voltage (Single-Ended)	-1945		-1625	-1945		-1625	-1945		-1625	mV
V_{BB}	Output Voltage Reference	-1525	-1425	-1325	-1525	-1425	-1325	-1525	-1425	-1325	mV
V_{IHCMR}	Input HIGH Voltage Common Mode Range (Differential Configuration) (Note 3)	$V_{EE}+2.0$		0.0	$V_{EE}+2.0$		0.0	$V_{EE}+2.0$		0.0	V
I_{IH}	Input HIGH Current			150			150			150	μA
I_{IL}	Input LOW Current	0.5			0.5			0.5			μA

NOTE: Device will meet the specifications after thermal equilibrium has been established when mounted in a test socket or printed circuit board with maintained transverse airflow greater than 500 lfm.

1. Input and output parameters vary 1:1 with V_{CC} .
2. All loading with $50\ \Omega$ to $V_{CC} - 2.0\text{ V}$.
3. V_{IHCMR} min varies 1:1 with V_{EE} , V_{IHCMR} max varies 1:1 with V_{CC} . The V_{IHCMR} range is referenced to the most positive side of the differential input signal.

Table 11. AC CHARACTERISTICS ($V_{CC} = 0\text{ V}$; $V_{EE} = -3.0\text{ V}$ to -5.5 V or $V_{CC} = 3.0\text{ V}$ to 5.5 V ; $V_{EE} = 0\text{ V}$ (Note 1))

Symbol	Characteristic	-40°C			25°C			85°C			Unit
		Min	Typ	Max	Min	Typ	Max	Min	Typ	Max	
V_{OPP}	Output Voltage Amplitude (See Figure 4) $f_{in} < 4.0\text{ GHz}$ $f_{in} < 4.5\text{ GHz}$		700 600			700 600			700 600		mV
t_{PLH} , t_{PHL}	Propagation Delay to CLK/Q Output Differential RESET/Q	300 370	380 420	440 470	300 370	380 420	440 470	320 400	400 450	460 500	ps
t_{RR}	Set/Rest Recovery	150	100		200	100		200	100		ps
t_{PW}	Minimum Pulse width RESET	550	480		550	480		550	480		ps
t_{JITTER}	Random Clock Jitter (RMS)		0.2	2		0.2	2		0.2	2	ps
V_{PP}	Input Voltage Swing (Differential Configuration)	150	800	1200	150	800	1200	150	800	1200	mV
t_r t_f	Output Rise/Fall Times Q, \bar{Q} (20%–80%)	90	170	200	100	180	250	120	200	280	ps

NOTE: Device will meet the specifications after thermal equilibrium has been established when mounted in a test socket or printed circuit board with maintained transverse airflow greater than 500 lfm.

1. Measured using a 750 mV source, 50% duty cycle clock source. All loading with $50\ \Omega$ to $V_{CC} - 2.0\text{ V}$.

MC10EP33, MC100EP33

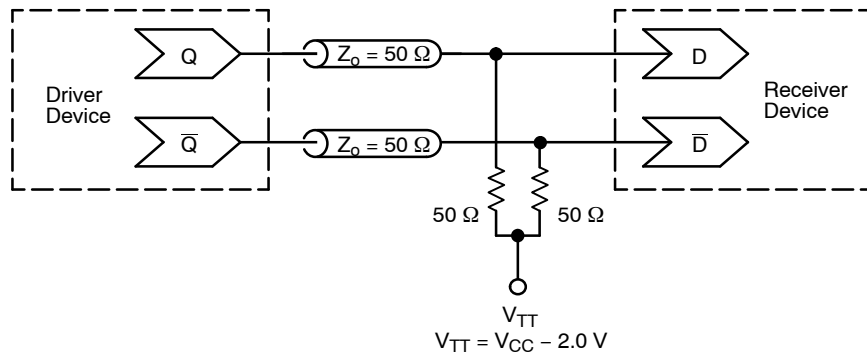

Figure 3. Typical Termination for Output Driver and Device Evaluation
 (See Application Note [AND8020/D](#) – Termination of ECL Logic Devices)

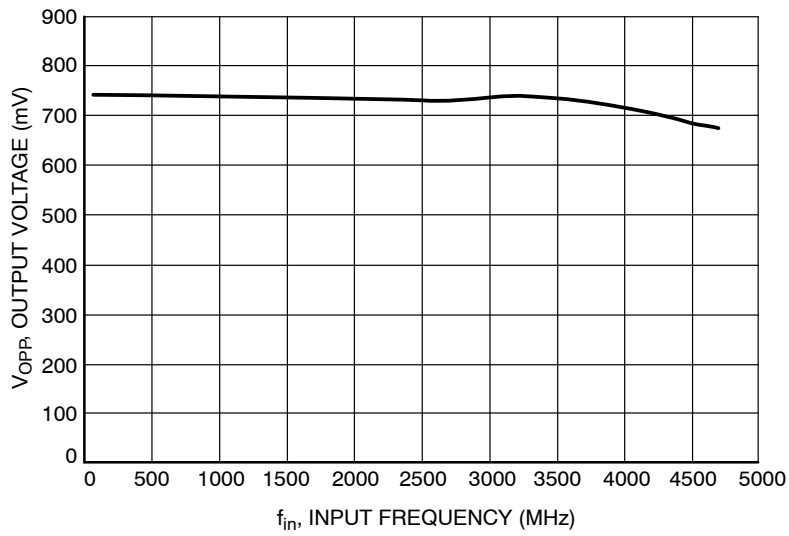

Figure 4. Input Frequency (f_{in}) versus Output Voltage (V_{Opp})

MC10EP33, MC100EP33

ORDERING INFORMATION

Device	Package	Shipping [†]
MC10EP33DG	SOIC-8 NB (Pb-Free)	98 Units / Tube
MC10EP33DR2G	SOIC-8 NB (Pb-Free)	2500 / Tape & Reel
MC10EP33DTG	TSSOP-8 (Pb-Free)	100 Units / Tube
MC100EP33DG	SOIC-8 NB (Pb-Free)	98 Units / Tube
MC100EP33DTG	TSSOP-8 (Pb-Free)	100 Units / Tube
MC100EP33DTR2G	TSSOP-8 (Pb-Free)	2500 / Tape & Reel
MC100EP33MNR4G	DFN8 (Pb-Free)	1000 / Tape & Reel

[†]For information on tape and reel specifications, including part orientation and tape sizes, please refer to our Tape and Reel Packaging Specifications Brochure, [BRD8011/D](#).

Resource Reference of Application Notes

- AN1405/D** – ECL Clock Distribution Techniques
- AN1406/D** – Designing with PECL (ECL at +5.0 V)
- AN1503/D** – ECLinPS™ I/O SPiCE Modeling Kit
- AN1504/D** – Metastability and the ECLinPS Family
- AN1568/D** – Interfacing Between LVDS and ECL
- AN1672/D** – The ECL Translator Guide
- AND8001/D** – Odd Number Counters Design
- AND8002/D** – Marking and Date Codes
- AND8020/D** – Termination of ECL Logic Devices
- AND8066/D** – Interfacing with ECLinPS
- AND8090/D** – AC Characteristics of ECL Devices

ECLinPS is a trademark of Semiconductor Components Industries, LLC (SCILLC) or its subsidiaries in the United States and/or other countries.

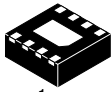

SCALE 4:1

DFN8 2x2, 0.5P
CASE 506AA
ISSUE F

DATE 04 MAY 2016

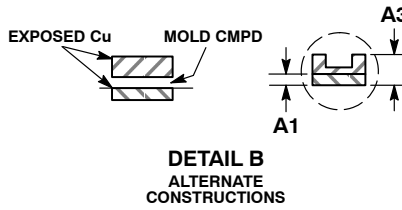
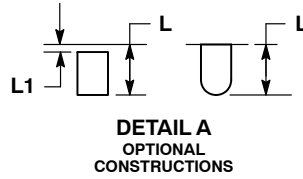

NOTES:

1. DIMENSIONING AND TOLERANCING PER ASME Y14.5M, 1994 .
2. CONTROLLING DIMENSION: MILLIMETERS.
3. DIMENSION b APPLIES TO PLATED TERMINAL AND IS MEASURED BETWEEN 0.15 AND 0.20 MM FROM TERMINAL TIP.
4. COPLANARITY APPLIES TO THE EXPOSED PAD AS WELL AS THE TERMINALS.

DIM	MILLIMETERS	
	MIN	MAX
A	0.80	1.00
A1	0.00	0.05
A3	0.20 REF	
b	0.20	0.30
D	2.00 BSC	
D2	1.10	1.30
E	2.00 BSC	
E2	0.70	0.90
e	0.50 BSC	
K	0.30 REF	
L	0.25	0.35
L1	---	0.10

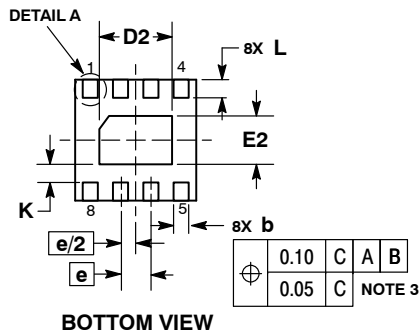

RECOMMENDED
SOLDERING FOOTPRINT*

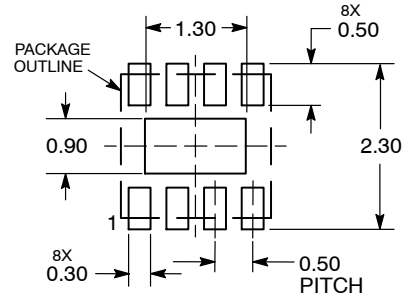

DIMENSIONS: MILLIMETERS

GENERIC
MARKING DIAGRAM*

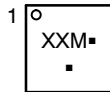

- XX = Specific Device Code
- M = Date Code
- = Pb-Free Device

*This information is generic. Please refer to device data sheet for actual part marking. Pb-Free indicator, "G" or microdot "▪", may or may not be present. Some products may not follow the Generic Marking.

*For additional information on our Pb-Free strategy and soldering details, please download the onsemi Soldering and Mounting Techniques Reference Manual, SOLDERRM/D.

DOCUMENT NUMBER:	98AON18658D	Electronic versions are uncontrolled except when accessed directly from the Document Repository. Printed versions are uncontrolled except when stamped "CONTROLLED COPY" in red.
DESCRIPTION:	DFN8, 2.0X2.0, 0.5MM PITCH	PAGE 1 OF 1

onsemi and onsemi are trademarks of Semiconductor Components Industries, LLC dba onsemi or its subsidiaries in the United States and/or other countries. onsemi reserves the right to make changes without further notice to any products herein. onsemi makes no warranty, representation or guarantee regarding the suitability of its products for any particular purpose, nor does onsemi assume any liability arising out of the application or use of any product or circuit, and specifically disclaims any and all liability, including without limitation special, consequential or incidental damages. onsemi does not convey any license under its patent rights nor the rights of others.

MECHANICAL CASE OUTLINE PACKAGE DIMENSIONS



SCALE 1:1

SOIC-8 NB
CASE 751-07
ISSUE AK

DATE 16 FEB 2011



- NOTES:
1. DIMENSIONING AND TOLERANCING PER ANSI Y14.5M, 1982.
 2. CONTROLLING DIMENSION: MILLIMETER.
 3. DIMENSION A AND B DO NOT INCLUDE MOLD PROTRUSION.
 4. MAXIMUM MOLD PROTRUSION 0.15 (0.006) PER SIDE.
 5. DIMENSION D DOES NOT INCLUDE DAMBAR PROTRUSION. ALLOWABLE DAMBAR PROTRUSION SHALL BE 0.127 (0.005) TOTAL IN EXCESS OF THE D DIMENSION AT MAXIMUM MATERIAL CONDITION.
 6. 751-01 THRU 751-06 ARE OBSOLETE. NEW STANDARD IS 751-07.

DIM	MILLIMETERS		INCHES	
	MIN	MAX	MIN	MAX
A	4.80	5.00	0.189	0.197
B	3.80	4.00	0.150	0.157
C	1.35	1.75	0.053	0.069
D	0.33	0.51	0.013	0.020
G	1.27 BSC		0.050 BSC	
H	0.10	0.25	0.004	0.010
J	0.19	0.25	0.007	0.010
K	0.40	1.27	0.016	0.050
M	0°	8°	0°	8°
N	0.25	0.50	0.010	0.020
S	5.80	6.20	0.228	0.244

SOLDERING FOOTPRINT*



*For additional information on our Pb-Free strategy and soldering details, please download the ON Semiconductor Soldering and Mounting Techniques Reference Manual, SOLDERRM/D.

GENERIC MARKING DIAGRAM*



XXXXXX = Specific Device Code
A = Assembly Location
L = Wafer Lot
Y = Year
W = Work Week
▪ = Pb-Free Package

XXXXXX = Specific Device Code
A = Assembly Location
Y = Year
WW = Work Week
▪ = Pb-Free Package

*This information is generic. Please refer to device data sheet for actual part marking. Pb-Free indicator, "G" or microdot "▪", may or may not be present. Some products may not follow the Generic Marking.

STYLES ON PAGE 2

DOCUMENT NUMBER:	98ASB42564B	Electronic versions are uncontrolled except when accessed directly from the Document Repository. Printed versions are uncontrolled except when stamped "CONTROLLED COPY" in red.
DESCRIPTION:	SOIC-8 NB	PAGE 1 OF 2

onsemi and ONsemi are trademarks of Semiconductor Components Industries, LLC dba onsemi or its subsidiaries in the United States and/or other countries. onsemi reserves the right to make changes without further notice to any products herein. onsemi makes no warranty, representation or guarantee regarding the suitability of its products for any particular purpose, nor does onsemi assume any liability arising out of the application or use of any product or circuit, and specifically disclaims any and all liability, including without limitation special, consequential or incidental damages. onsemi does not convey any license under its patent rights nor the rights of others.

SOIC-8 NB
CASE 751-07
ISSUE AK

DATE 16 FEB 2011

- | | | | |
|---|--|--|--|
| <p>STYLE 1:
 PIN 1. EMITTER
 2. COLLECTOR
 3. COLLECTOR
 4. EMITTER
 5. EMITTER
 6. BASE
 7. BASE
 8. EMITTER</p> | <p>STYLE 2:
 PIN 1. COLLECTOR, DIE, #1
 2. COLLECTOR, #1
 3. COLLECTOR, #2
 4. COLLECTOR, #2
 5. BASE, #2
 6. EMITTER, #2
 7. BASE, #1
 8. EMITTER, #1</p> | <p>STYLE 3:
 PIN 1. DRAIN, DIE #1
 2. DRAIN, #1
 3. DRAIN, #2
 4. DRAIN, #2
 5. GATE, #2
 6. SOURCE, #2
 7. GATE, #1
 8. SOURCE, #1</p> | <p>STYLE 4:
 PIN 1. ANODE
 2. ANODE
 3. ANODE
 4. ANODE
 5. ANODE
 6. ANODE
 7. ANODE
 8. COMMON CATHODE</p> |
| <p>STYLE 5:
 PIN 1. DRAIN
 2. DRAIN
 3. DRAIN
 4. DRAIN
 5. GATE
 6. GATE
 7. SOURCE
 8. SOURCE</p> | <p>STYLE 6:
 PIN 1. SOURCE
 2. DRAIN
 3. DRAIN
 4. SOURCE
 5. SOURCE
 6. GATE
 7. GATE
 8. SOURCE</p> | <p>STYLE 7:
 PIN 1. INPUT
 2. EXTERNAL BYPASS
 3. THIRD STAGE SOURCE
 4. GROUND
 5. DRAIN
 6. GATE 3
 7. SECOND STAGE Vd
 8. FIRST STAGE Vd</p> | <p>STYLE 8:
 PIN 1. COLLECTOR, DIE #1
 2. BASE, #1
 3. BASE, #2
 4. COLLECTOR, #2
 5. COLLECTOR, #2
 6. EMITTER, #2
 7. EMITTER, #1
 8. COLLECTOR, #1</p> |
| <p>STYLE 9:
 PIN 1. EMITTER, COMMON
 2. COLLECTOR, DIE #1
 3. COLLECTOR, DIE #2
 4. EMITTER, COMMON
 5. EMITTER, COMMON
 6. BASE, DIE #2
 7. BASE, DIE #1
 8. EMITTER, COMMON</p> | <p>STYLE 10:
 PIN 1. GROUND
 2. BIAS 1
 3. OUTPUT
 4. GROUND
 5. GROUND
 6. BIAS 2
 7. INPUT
 8. GROUND</p> | <p>STYLE 11:
 PIN 1. SOURCE 1
 2. GATE 1
 3. SOURCE 2
 4. GATE 2
 5. DRAIN 2
 6. DRAIN 2
 7. DRAIN 1
 8. DRAIN 1</p> | <p>STYLE 12:
 PIN 1. SOURCE
 2. SOURCE
 3. SOURCE
 4. GATE
 5. DRAIN
 6. DRAIN
 7. DRAIN
 8. DRAIN</p> |
| <p>STYLE 13:
 PIN 1. N.C.
 2. SOURCE
 3. SOURCE
 4. GATE
 5. DRAIN
 6. DRAIN
 7. DRAIN
 8. DRAIN</p> | <p>STYLE 14:
 PIN 1. N-SOURCE
 2. N-GATE
 3. P-SOURCE
 4. P-GATE
 5. P-DRAIN
 6. P-DRAIN
 7. N-DRAIN
 8. N-DRAIN</p> | <p>STYLE 15:
 PIN 1. ANODE 1
 2. ANODE 1
 3. ANODE 1
 4. ANODE 1
 5. CATHODE, COMMON
 6. CATHODE, COMMON
 7. CATHODE, COMMON
 8. CATHODE, COMMON</p> | <p>STYLE 16:
 PIN 1. EMITTER, DIE #1
 2. BASE, DIE #1
 3. EMITTER, DIE #2
 4. BASE, DIE #2
 5. COLLECTOR, DIE #2
 6. COLLECTOR, DIE #2
 7. COLLECTOR, DIE #1
 8. COLLECTOR, DIE #1</p> |
| <p>STYLE 17:
 PIN 1. VCC
 2. V2OUT
 3. V1OUT
 4. TXE
 5. RXE
 6. VEE
 7. GND
 8. ACC</p> | <p>STYLE 18:
 PIN 1. ANODE
 2. ANODE
 3. SOURCE
 4. GATE
 5. DRAIN
 6. DRAIN
 7. CATHODE
 8. CATHODE</p> | <p>STYLE 19:
 PIN 1. SOURCE 1
 2. GATE 1
 3. SOURCE 2
 4. GATE 2
 5. DRAIN 2
 6. MIRROR 2
 7. DRAIN 1
 8. MIRROR 1</p> | <p>STYLE 20:
 PIN 1. SOURCE (N)
 2. GATE (N)
 3. SOURCE (P)
 4. GATE (P)
 5. DRAIN
 6. DRAIN
 7. DRAIN
 8. DRAIN</p> |
| <p>STYLE 21:
 PIN 1. CATHODE 1
 2. CATHODE 2
 3. CATHODE 3
 4. CATHODE 4
 5. CATHODE 5
 6. COMMON ANODE
 7. COMMON ANODE
 8. CATHODE 6</p> | <p>STYLE 22:
 PIN 1. I/O LINE 1
 2. COMMON CATHODE/VCC
 3. COMMON CATHODE/VCC
 4. I/O LINE 3
 5. COMMON ANODE/GND
 6. I/O LINE 4
 7. I/O LINE 5
 8. COMMON ANODE/GND</p> | <p>STYLE 23:
 PIN 1. LINE 1 IN
 2. COMMON ANODE/GND
 3. COMMON ANODE/GND
 4. LINE 2 IN
 5. LINE 2 OUT
 6. COMMON ANODE/GND
 7. COMMON ANODE/GND
 8. LINE 1 OUT</p> | <p>STYLE 24:
 PIN 1. BASE
 2. EMITTER
 3. COLLECTOR/ANODE
 4. COLLECTOR/ANODE
 5. CATHODE
 6. CATHODE
 7. COLLECTOR/ANODE
 8. COLLECTOR/ANODE</p> |
| <p>STYLE 25:
 PIN 1. VIN
 2. N/C
 3. REXT
 4. GND
 5. IOUT
 6. IOUT
 7. IOUT
 8. IOUT</p> | <p>STYLE 26:
 PIN 1. GND
 2. dv/dt
 3. ENABLE
 4. ILIMIT
 5. SOURCE
 6. SOURCE
 7. SOURCE
 8. VCC</p> | <p>STYLE 27:
 PIN 1. ILIMIT
 2. OVLO
 3. UVLO
 4. INPUT+
 5. SOURCE
 6. SOURCE
 7. SOURCE
 8. DRAIN</p> | <p>STYLE 28:
 PIN 1. SW_TO_GND
 2. DASIC_OFF
 3. DASIC_SW_DET
 4. GND
 5. V_MON
 6. VBULK
 7. VBULK
 8. VIN</p> |
| <p>STYLE 29:
 PIN 1. BASE, DIE #1
 2. EMITTER, #1
 3. BASE, #2
 4. EMITTER, #2
 5. COLLECTOR, #2
 6. COLLECTOR, #2
 7. COLLECTOR, #1
 8. COLLECTOR, #1</p> | <p>STYLE 30:
 PIN 1. DRAIN 1
 2. DRAIN 1
 3. GATE 2
 4. SOURCE 2
 5. SOURCE 1/DRAIN 2
 6. SOURCE 1/DRAIN 2
 7. SOURCE 1/DRAIN 2
 8. GATE 1</p> | | |

DOCUMENT NUMBER:	98ASB42564B	Electronic versions are uncontrolled except when accessed directly from the Document Repository. Printed versions are uncontrolled except when stamped "CONTROLLED COPY" in red.
DESCRIPTION:	SOIC-8 NB	PAGE 2 OF 2

onsemi and **ONSEMI** are trademarks of Semiconductor Components Industries, LLC dba **onsemi** or its subsidiaries in the United States and/or other countries. **onsemi** reserves the right to make changes without further notice to any products herein. **onsemi** makes no warranty, representation or guarantee regarding the suitability of its products for any particular purpose, nor does **onsemi** assume any liability arising out of the application or use of any product or circuit, and specifically disclaims any and all liability, including without limitation special, consequential or incidental damages. **onsemi** does not convey any license under its patent rights nor the rights of others.

MECHANICAL CASE OUTLINE

PACKAGE DIMENSIONS

ON Semiconductor®



SCALE 2:1

TSSOP 8 CASE 948R-02 ISSUE A

DATE 04/07/2000



NOTES:

1. DIMENSIONING AND TOLERANCING PER ANSI Y14.5M, 1982.
2. CONTROLLING DIMENSION: MILLIMETER.
3. DIMENSION A DOES NOT INCLUDE MOLD FLASH. PROTRUSIONS OR GATE BURRS. MOLD FLASH OR GATE BURRS SHALL NOT EXCEED 0.15 (0.006) PER SIDE.
4. DIMENSION B DOES NOT INCLUDE INTERLEAD FLASH OR PROTRUSION. INTERLEAD FLASH OR PROTRUSION SHALL NOT EXCEED 0.25 (0.010) PER SIDE.
5. TERMINAL NUMBERS ARE SHOWN FOR REFERENCE ONLY.
6. DIMENSION A AND B ARE TO BE DETERMINED AT DATUM PLANE -V-.

DIM	MILLIMETERS		INCHES	
	MIN	MAX	MIN	MAX
A	2.90	3.10	0.114	0.122
B	2.90	3.10	0.114	0.122
C	0.80	1.10	0.031	0.043
D	0.05	0.15	0.002	0.006
F	0.40	0.70	0.016	0.028
G	0.65 BSC		0.026 BSC	
K	0.25	0.40	0.010	0.016
L	4.90 BSC		0.193 BSC	
M	0°	6°	0°	6°

DOCUMENT NUMBER:	98AON00236D	Electronic versions are uncontrolled except when accessed directly from the Document Repository. Printed versions are uncontrolled except when stamped "CONTROLLED COPY" in red.
DESCRIPTION:	TSSOP 8	PAGE 1 OF 1

ON Semiconductor and ON are trademarks of Semiconductor Components Industries, LLC dba ON Semiconductor or its subsidiaries in the United States and/or other countries. ON Semiconductor reserves the right to make changes without further notice to any products herein. ON Semiconductor makes no warranty, representation or guarantee regarding the suitability of its products for any particular purpose, nor does ON Semiconductor assume any liability arising out of the application or use of any product or circuit, and specifically disclaims any and all liability, including without limitation special, consequential or incidental damages. ON Semiconductor does not convey any license under its patent rights nor the rights of others.

onsemi, **Onsemi**, and other names, marks, and brands are registered and/or common law trademarks of Semiconductor Components Industries, LLC dba "**onsemi**" or its affiliates and/or subsidiaries in the United States and/or other countries. **onsemi** owns the rights to a number of patents, trademarks, copyrights, trade secrets, and other intellectual property. A listing of **onsemi**'s product/patent coverage may be accessed at www.onsemi.com/site/pdf/Patent-Marking.pdf. **onsemi** reserves the right to make changes at any time to any products or information herein, without notice. The information herein is provided "as-is" and **onsemi** makes no warranty, representation or guarantee regarding the accuracy of the information, product features, availability, functionality, or suitability of its products for any particular purpose, nor does **onsemi** assume any liability arising out of the application or use of any product or circuit, and specifically disclaims any and all liability, including without limitation special, consequential or incidental damages. Buyer is responsible for its products and applications using **onsemi** products, including compliance with all laws, regulations and safety requirements or standards, regardless of any support or applications information provided by **onsemi**. "Typical" parameters which may be provided in **onsemi** data sheets and/or specifications can and do vary in different applications and actual performance may vary over time. All operating parameters, including "Typicals" must be validated for each customer application by customer's technical experts. **onsemi** does not convey any license under any of its intellectual property rights nor the rights of others. **onsemi** products are not designed, intended, or authorized for use as a critical component in life support systems or any FDA Class 3 medical devices or medical devices with a same or similar classification in a foreign jurisdiction or any devices intended for implantation in the human body. Should Buyer purchase or use **onsemi** products for any such unintended or unauthorized application, Buyer shall indemnify and hold **onsemi** and its officers, employees, subsidiaries, affiliates, and distributors harmless against all claims, costs, damages, and expenses, and reasonable attorney fees arising out of, directly or indirectly, any claim of personal injury or death associated with such unintended or unauthorized use, even if such claim alleges that **onsemi** was negligent regarding the design or manufacture of the part. **onsemi** is an Equal Opportunity/Affirmative Action Employer. This literature is subject to all applicable copyright laws and is not for resale in any manner.

ADDITIONAL INFORMATION

TECHNICAL PUBLICATIONS:

Technical Library: www.onsemi.com/design/resources/technical-documentation
onsemi Website: www.onsemi.com

ONLINE SUPPORT: www.onsemi.com/support

For additional information, please contact your local Sales Representative at www.onsemi.com/support/sales

