



# LUXEON CoB Core Range

Uniform, high efficacy and easy to design array

LUXEON CoB represents a new breakthrough for arrays. The efficacies will be >160 lm/W for 70CRI and 80CRI products. Due to its small Light Emitting Surface (LES) and industry-leading thermal resistance, LUXEON CoB is easy to work with, enabling simplified and less expensive luminaire designs. LUXEON CoBs are hot-tested at 85°C—real world operating conditions—which means additional testing can be minimized. LUXEON CoB LEDs are available in 3-step MacAdam ellipse, ensuring uniform optical performance in a wide range of applications.



## FEATURES AND BENEFITS

Highest flux densities with industry's smallest LES

3-step MacAdam ellipse color definition: *Freedom from Binning* for color consistency from luminaire to luminaire

Up to 4x lower thermal resistance than competition, enabling smaller heatsinks and higher lumens

Supported by a comprehensive optical, mechanical and electrical ecosystem

## PRIMARY APPLICATIONS

Spotlights

Track Lights

Downlights

High Bay

Low Bay

Floodlights

[More...](#)

# Table of Contents

<b>General Product Information</b> .....	<b>2</b>
Product Test Conditions .....	2
Part Number Nomenclature .....	2
Lumen Maintenance .....	2
Environmental Compliance .....	3
<b>Performance Characteristics</b> .....	<b>3</b>
Product Selection Guide .....	3
Optical Characteristics .....	11
Electrical and Thermal Characteristics .....	11
<b>Absolute Maximum Ratings</b> .....	<b>12</b>
<b>Characteristic Curves</b> .....	<b>13</b>
Spectral Power Distribution Characteristics .....	13
Light Output Characteristics .....	15
Forward Current Characteristics .....	16
Radiation Pattern Characteristics .....	18
<b>Color Bin Definitions</b> .....	<b>19</b>
<b>Mechanical Dimensions</b> .....	<b>20</b>
<b>Packaging and Labeling Information</b> .....	<b>23</b>
Tube .....	23
Inner Box .....	25
Outer Box .....	26

# General Product Information

## Product Test Conditions

LUXEON CoB Core Range LEDs are tested and binned with a DC drive current specified below at a junction temperature,  $T_j$ , of 85°C:

200mA	-	LUXEON CoB 1202s
200mA	-	LUXEON CoB 1202
300mA	-	LUXEON CoB 1203
450mA	-	LUXEON CoB 1204
600mA	-	LUXEON CoB 1205
900mA	-	LUXEON CoB 1208
1200mA	-	LUXEON CoB 1211
1600mA	-	LUXEON CoB 1216
1200mA	-	LUXEON CoB 1812
2100mA	-	LUXEON CoB 1321
2250mA	-	LUXEON CoB 1825

## Part Number Nomenclature

Part numbers for LUXEON CoB Core Range follow the convention below:

L 2 C 5 – **A A B B C C C C D E E F F**

Where:

- A A** – designates nominal CCT (22=2200K, 27=2700K, 30=3000K, 35=3500K, 40=4000K, 50=5000K, 56=5600K, 57=5700K, 65=6500K)
- B B** – designates minimum CRI (60=60CRI, 70=70CRI, 80=80CRI, 90=90CRI, 95=95CRI)
- C C C C** – designates product configuration (example: 1202, 1203, 1204, 1205, 1208, 1211, 1216, 1812, 1321, 1825)
- D** – designates options for product specification
- E E** – designates light emitting surface (LES) size (06=6mm, 09=9mm, 13=13mm, 15=15mm, 19=19mm, 23=23mm, 29=29mm, 32=32mm)
- F F** – designates options for product specification

Therefore, the following part number is used for a LUXEON CoB 1203, Gen 4, 3000K 80CRI, with a 9mm LES:

L 2 C 5 – **3 0 8 0 1 2 0 3 F 0 9 0 0**

## Lumen Maintenance

Please contact your local Sales Representative or Lumileds Technical Solutions Manager for more information about the long-term performance of this product.

## Environmental Compliance

Lumileds LLC is committed to providing environmentally friendly products to the solid-state lighting market. LUXEON CoB Core Range is compliant to the European Union directives on the restriction of hazardous substances in electronic equipment, namely the RoHS Directive 2011/65/EU and REACH Regulation (EC) 1907/2006. Lumileds LLC will not intentionally add the following restricted materials to its products: lead, mercury, cadmium, hexavalent chromium, polybrominated biphenyls (PBB) or polybrominated diphenyl ethers (PBDE).

## Performance Characteristics

### Product Selection Guide

Table 1. Product performance of LUXEON CoB Core Range at specified test current,  $T_j=85^\circ\text{C}$ .

PRODUCT	NOMINAL CCT	MINIMUM CRI <sup>[1, 2, 3]</sup>	LUMINOUS FLUX <sup>[1]</sup> (lm)		TYPICAL LUMINOUS EFFICACY (lm/W)	TEST CURRENT (mA)	LES <sup>[4]</sup> (mm)	PART NUMBER
			MINIMUM	TYPICAL				
LUXEON CoB 1202s	2200K	80	675	750	109	200	6	L2C5-22801202E0600
	2700K	80	797	886	128	200	6	L2C5-27801202E0600
	3000K	80	837	930	135	200	6	L2C5-30801202E0600
	3500K	80	854	949	138	200	6	L2C5-35801202E0600
	4000K	80	863	959	139	200	6	L2C5-40801202E0600
	5000K	80	863	959	139	200	6	L2C5-50801202E0600
	2200K <sup>[5]</sup>	90	589	654	95	200	6	L2C5-22901202E0600
	2700K	90	662	736	107	200	6	L2C5-27901202E0600
	3000K	90	689	766	111	200	6	L2C5-30901202E0600
	3500K	90	725	805	117	200	6	L2C5-35901202E0600
LUXEON CoB 1202	4000K	90	742	824	119	200	6	L2C5-40901202E0600
	3000K	70	923	1026	149	200	9	L2C5-30701202E0900
	3500K	70	923	1026	149	200	9	L2C5-35701202E0900
	4000K	70	968	1075	156	200	9	L2C5-40701202E0900
	5000K	70	968	1075	156	200	9	L2C5-50701202E0900
	5700K	70	942	1047	152	200	9	L2C5-57701202E0900
	2200K	80	703	781	113	200	9	L2C5-22801202E0900
	2700K	80	830	922	134	200	9	L2C5-27801202E0900
	3000K	80	876	973	141	200	9	L2C5-30801202E0900
	3500K	80	893	992	144	200	9	L2C5-35801202E0900
LUXEON CoB 1202	4000K	80	899	999	145	200	9	L2C5-40801202E0900
	5000K	80	899	999	145	200	9	L2C5-50801202E0900
	2200K <sup>[5]</sup>	90	625	694	101	200	9	L2C5-22901202E0900
	2700K	90	690	766	111	200	9	L2C5-27901202E0900
	3000K	90	729	810	117	200	9	L2C5-30901202E0900
	3500K	90	752	836	121	200	9	L2C5-35901202E0900
	4000K	90	772	858	124	200	9	L2C5-40901202E0900

Table 1 continued on next page.

1. Lumileds maintains a tolerance of  $\pm 2$  on CRI and  $\pm 6.5\%$  on luminous flux measurements.
2. Typical CRI is approximately 2 points higher than the minimum CRI specified, but this is not guaranteed.
3. R9 value of 90CRI products is  $>50$ .
4. Light Emitting Surface (LES) is the inner diameter (phosphor area) inside the dam.
5. Atmosphere Technology creates the ideal ambiance for restaurants and other hospitality venues.

Table 1. Product performance of LUXEON CoB Core Range at specified test current, T<sub>j</sub>=85°C (continued).

PRODUCT	NOMINAL CCT	MINIMUM CRI <sup>[1, 2, 3]</sup>	LUMINOUS FLUX <sup>[1]</sup> (lm)		TYPICAL LUMINOUS EFFICACY (lm/W)	TEST CURRENT (mA)	LES <sup>[4]</sup> (mm)	PART NUMBER
			MINIMUM	TYPICAL				
LUXEON CoB 1203	3000K	70	1475	1639	158	300	9	L2C5-30701203F0900
		70	1379	1532	148	300	9	L2C5-30701203E0900
	3500K	70	1379	1532	148	300	9	L2C5-35701203E0900
	4000K	70	1569	1743	168	300	9	L2C5-40701203F0900
		70	1466	1629	157	300	9	L2C5-40701203E0900
	5000K	70	1466	1629	157	300	9	L2C5-50701203E0900
	5700K	70	1428	1587	153	300	9	L2C5-57701203E0900
	6500K	70	1391	1546	149	300	9	L2C5-65701203E0900
	2200K	80	1066	1184	114	300	9	L2C5-22801203E0900
	2700K	80	1359	1510	146	300	9	L2C5-27801203F0900
		80	1258	1398	135	300	9	L2C5-27801203E0900
	3000K	80	1392	1547	149	300	9	L2C5-30801203F0900
		80	1289	1432	138	300	9	L2C5-30801203E0900
	3500K	80	1420	1578	152	300	9	L2C5-35801203F0900
		80	1315	1461	141	300	9	L2C5-35801203E0900
	4000K	80	1472	1635	158	300	9	L2C5-40801203F0900
		80	1363	1514	146	300	9	L2C5-40801203E0900
	5000K	80	1472	1635	158	300	9	L2C5-50801203F0900
		80	1363	1514	146	300	9	L2C5-50801203E0900
	5700K	80	1359	1510	146	300	9	L2C5-57801203E0900
	2200K <sup>[5]</sup>	90	929	1032	100	300	9	L2C5-22901203E0900
	2700K	90	1170	1300	125	300	9	L2C5-27901203F0900
		90	1045	1161	112	300	9	L2C5-27901203E0900
	3000K	90	1210	1344	130	300	9	L2C5-30901203F0900
		90	1080	1200	116	300	9	L2C5-30901203E0900
	3500K	90	1258	1398	134	300	9	L2C5-35901203F0900
		90	1140	1267	122	300	9	L2C5-35901203E0900
	4000K	90	1251	1390	134	300	9	L2C5-40901203F0900
		90	1170	1301	126	300	9	L2C5-40901203E0900
	2700K	95	999	1110	107	300	9	L2C5-27951203F0900
3000K	95	1053	1170	113	300	9	L2C5-30951203F0900	

Notes:

1. Lumileds maintains a tolerance of ±2 on CRI and ±6.5% on luminous flux measurements.
2. Typical CRI is approximately 2 points higher than the minimum CRI specified, but this is not guaranteed.
3. R9 value of 90CRI products is >50.
4. Light Emitting Surface (LES) is the inner diameter (phosphor area) inside the dam.
5. AtmoSphere Technology creates the ideal ambiance for restaurants and other hospitality venues.

Table 1. Product performance of LUXEON CoB Core Range at specified test current, T<sub>j</sub>=85°C (continued).

PRODUCT	NOMINAL CCT	MINIMUM CRI <sup>[1, 2, 3]</sup>	LUMINOUS FLUX <sup>[1]</sup> (lm)		TYPICAL LUMINOUS EFFICACY (lm/W)	TEST CURRENT (mA)	LES <sup>[4]</sup> (mm)	PART NUMBER
			MINIMUM	TYPICAL				
LUXEON CoB 1204	3000K	70	2124	2360	151	450	13	L2C5-30701204E1300
	3500K	70	2124	2360	151	450	13	L2C5-35701204E1300
	4000K	70	2258	2509	160	450	13	L2C5-40701204E1300
	5000K	70	2258	2509	160	450	13	L2C5-50701204E1300
	5700K	70	2199	2443	156	450	13	L2C5-57701204E1300
	6500K	70	2142	2380	152	450	13	L2C5-65701204E1300
	2200K	80	1641	1823	117	450	13	L2C5-22801204E1300
	2700K	80	2092	2324	149	450	13	L2C5-27801204F1300
		80	1937	2152	138	450	13	L2C5-27801204E1300
	3000K	80	2138	2376	152	450	13	L2C5-30801204F1300
		80	1980	2200	141	450	13	L2C5-30801204E1300
	3500K	80	2020	2244	144	450	13	L2C5-35801204E1300
	4000K	80	2253	2504	160	450	13	L2C5-40801204F1300
		80	2098	2332	149	450	13	L2C5-40801204E1300
	5000K	80	2098	2332	149	450	13	L2C5-50801204E1300
	5700K	80	2093	2325	148	450	13	L2C5-57801204E1300
	2200K <sup>[5]</sup>	90	1430	1589	102	450	13	L2C5-22901204E1300
	2700K	90	1802	2003	129	450	13	L2C5-27901204F1300
		90	1609	1788	115	450	13	L2C5-27901204E1300
	3000K	90	1855	2061	132	450	13	L2C5-30901204F1300
		90	1656	1840	118	450	13	L2C5-30901204E1300
	3500K	90	1929	2143	137	450	13	L2C5-35901204F1300
		90	1755	1950	125	450	13	L2C5-35901204E1300
	4000K	90	1802	2003	128	450	13	L2C5-40901204E1300

Notes:

1. Lumileds maintains a tolerance of ±2 on CRI and ±6.5% on luminous flux measurements.
2. Typical CRI is approximately 2 points higher than the minimum CRI specified, but this is not guaranteed.
3. R9 value of 90CRI products is >50.
4. Light Emitting Surface (LES) is the inner diameter (phosphor area) inside the dam.
5. AtmoSphere Technology creates the ideal ambiance for restaurants and other hospitality venues.

Table 1. Product performance of LUXEON CoB Core Range at specified test current, T<sub>j</sub>=85°C (continued).

PRODUCT	NOMINAL CCT	MINIMUM CRI <sup>[1, 2, 3]</sup>	LUMINOUS FLUX <sup>[1]</sup> (lm)		TYPICAL LUMINOUS EFFICACY (lm/W)	TEST CURRENT (mA)	LES <sup>[4]</sup> (mm)	PART NUMBER
			MINIMUM	TYPICAL				
LUXEON CoB 1205	3000K	70	2958	3287	157	600	13	L2C5-30701205F1300
		70	2765	3072	146	600	13	L2C5-30701205E1300
	3500K	70	2765	3072	146	600	13	L2C5-35701205E1300
	4000K	70	3137	3486	166	600	13	L2C5-40701205F1300
		70	2932	3258	155	600	13	L2C5-40701205E1300
	5000K	70	2932	3258	155	600	13	L2C5-50701205E1300
	5700K	70	2856	3173	151	600	13	L2C5-57701205E1300
	6500K	70	2782	3091	147	600	13	L2C5-65701205E1300
	2200K	80	2131	2368	113	600	13	L2C5-22801205E1300
	2700K	80	2717	3019	144	600	13	L2C5-27801205F1300
		80	2516	2795	133	600	13	L2C5-27801205E1300
	3000K	80	2824	3137	149	600	13	L2C5-30801205F1300
		80	2615	2905	138	600	13	L2C5-30801205E1300
	3500K	80	2880	3200	152	600	13	L2C5-35801205F1300
		80	2667	2963	141	600	13	L2C5-35801205E1300
	4000K	80	2943	3270	156	600	13	L2C5-40801205F1300
		80	2725	3028	144	600	13	L2C5-40801205E1300
	5000K	80	2943	3270	156	600	13	L2C5-50801205F1300
		80	2725	3028	144	600	13	L2C5-50801205E1300
	5700K	80	2934	3261	156	600	13	L2C5-57801205F1300
		80	2717	3019	144	600	13	L2C5-57801205E1300
	6500K	80	2861	3179	152	600	13	L2C5-65801205F1300
	2200K <sup>[5]</sup>	90	1857	2063	98	600	13	L2C5-22901205E1300
	2700K	90	2341	2601	124	600	13	L2C5-27901205F1300
		90	2090	2322	111	600	13	L2C5-27901205E1300
	3000K	90	2437	2708	129	600	13	L2C5-30901205F1300
		90	2176	2418	115	600	13	L2C5-30901205E1300
	3500K	90	2535	2816	135	600	13	L2C5-35901205F1300
		90	2280	2533	121	600	13	L2C5-35901205E1300
	4000K	90	2622	2913	139	600	13	L2C5-40901205F1300
		90	2341	2601	124	600	13	L2C5-40901205E1300
	5000K	90	2623	2914	144	600	13	L2C5-50901205F1300
2700K	95	2007	2230	106	600	13	L2C5-27951205F1300	
3000K	95	2097	2330	111	600	13	L2C5-30951205F1300	

Notes:

1. Lumileds maintains a tolerance of ±2 on CRI and ±6.5% on luminous flux measurements.
2. Typical CRI is approximately 2 points higher than the minimum CRI specified, but this is not guaranteed.
3. R9 value of 90CRI products is >50.
4. Light Emitting Surface (LES) is the inner diameter (phosphor area) inside the dam.
5. AtmoSphere Technology creates the ideal ambiance for restaurants and other hospitality venues.

Table 1. Product performance of LUXEON CoB Core Range at specified test current, T<sub>j</sub>=85°C (continued).

PRODUCT	NOMINAL CCT	MINIMUM CRI <sup>[1, 2, 3]</sup>	LUMINOUS FLUX <sup>[1]</sup> (lm)		TYPICAL LUMINOUS EFFICACY (lm/W)	TEST CURRENT (mA)	LES <sup>[4]</sup> (mm)	PART NUMBER
			MINIMUM	TYPICAL				
LUXEON CoB 1208	3000K	70	4439	4933	157	900	15	L2C5-30701208F1500
		70	4149	4610	147	900	15	L2C5-30701208E1500
	3500K	70	4149	4610	147	900	15	L2C5-35701208E1500
	4000K	70	4651	5243	167	900	15	L2C5-40701208F1500
		70	4347	4900	156	900	15	L2C5-40701208E1500
	5000K	70	4651	5243	167	900	15	L2C5-50701208F1500
		70	4347	4900	156	900	15	L2C5-50701208E1500
	5700K	70	4584	5093	163	900	15	L2C5-57701208F1500
		70	4284	4760	152	900	15	L2C5-57701208E1500
	6500K	70	4465	4962	158	900	15	L2C5-65701208F1500
		70	4173	4637	148	900	15	L2C5-65701208E1500
	2200K	80	3197	3552	114	900	15	L2C5-22801208E1500
	2700K	80	4076	4528	145	900	15	L2C5-27801208F1500
		80	3774	4193	134	900	15	L2C5-27801208E1500
	3000K	80	4245	4717	151	900	15	L2C5-30801208F1500
		80	3931	4368	140	900	15	L2C5-30801208E1500
	3500K	80	4331	4811	154	900	15	L2C5-35801208F1500
		80	4010	4455	143	900	15	L2C5-35801208E1500
	4000K	80	4415	4905	157	900	15	L2C5-40801208F1500
		80	4088	4542	145	900	15	L2C5-40801208E1500
	5000K	80	4415	4905	157	900	15	L2C5-50801208F1500
		80	4088	4542	145	900	15	L2C5-50801208E1500
	5700K	80	4402	4891	157	900	15	L2C5-57801208F1500
		80	4076	4529	145	900	15	L2C5-57801208E1500
	6500K	80	4292	4769	152	900	15	L2C5-65801208F1500
	2200K <sup>[5]</sup>	90	2785	3095	99	900	15	L2C5-22901208E1500
	2700K	90	3514	3904	125	900	15	L2C5-27901208F1500
		90	3137	3486	111	900	15	L2C5-27901208E1500
	3000K	90	3639	4043	130	900	15	L2C5-30901208F1500
		90	3249	3610	116	900	15	L2C5-30901208E1500
	3500K	90	3784	4205	134	900	15	L2C5-35901208F1500
		90	3420	3800	122	900	15	L2C5-35901208E1500
4000K	90	3932	4370	140	900	15	L2C5-40901208F1500	
	90	3511	3902	125	900	15	L2C5-40901208E1500	
2700K	95	3015	3350	107	900	15	L2C5-27951208F1500	
3000K	95	3150	3500	112	900	15	L2C5-30951208F1500	

Notes:

1. Lumileds maintains a tolerance of ±2 on CRI and ±6.5% on luminous flux measurements.
2. Typical CRI is approximately 2 points higher than the minimum CRI specified, but this is not guaranteed.
3. R9 value of 90CRI products is >50.
4. Light Emitting Surface (LES) is the inner diameter (phosphor area) inside the dam.
5. AtmoSphere Technology creates the ideal ambiance for restaurants and other hospitality venues.



Table 1. Product performance of LUXEON CoB Core Range at specified test current, T<sub>j</sub>=85°C (continued).

PRODUCT	NOMINAL CCT	MINIMUM CRI <sup>[1, 2, 3]</sup>	LUMINOUS FLUX <sup>[1]</sup> (lm)		TYPICAL LUMINOUS EFFICACY (lm/W)	TEST CURRENT (mA)	LES <sup>[4]</sup> (mm)	PART NUMBER
			MINIMUM	TYPICAL				
LUXEON CoB 1211	3000K	70	6133	6739	161	1200	19	L2C5-30701211F1900
		70	5695	6328	152	1200	19	L2C5-30701211E1900
	3500K	70	5695	6328	152	1200	19	L2C5-35701211E1900
	4000K	70	6519	7163	172	1200	19	L2C5-40701211F1900
		70	6053	6726	162	1200	19	L2C5-40701211E1900
	5000K	70	6519	7163	172	1200	19	L2C5-50701211F1900
		70	6053	6726	162	1200	19	L2C5-50701211E1900
	5700K	70	6334	6961	167	1200	19	L2C5-57701211F1900
		70	5882	6536	157	1200	19	L2C5-57701211E1900
	6500K	70	6172	6782	162	1200	19	L2C5-65701211F1900
		70	5731	6368	152	1200	19	L2C5-65701211E1900
	2200K	80	4390	4878	117	1200	19	L2C5-22801211E1900
	2700K	80	5580	6132	147	1200	19	L2C5-27801211F1900
		80	5183	5758	138	1200	19	L2C5-27801211E1900
	3000K	80	5737	6305	151	1200	19	L2C5-30801211F1900
		80	5328	5920	142	1200	19	L2C5-30801211E1900
	3500K	80	5852	6430	154	1200	19	L2C5-35801211F1900
		80	5435	6038	145	1200	19	L2C5-35801211E1900
	4000K	80	6046	6643	159	1200	19	L2C5-40801211F1900
		80	5614	6238	150	1200	19	L2C5-40801211E1900
	5000K	80	6046	6643	159	1200	19	L2C5-50801211F1900
		80	5614	6238	150	1200	19	L2C5-50801211E1900
	5700K	80	6028	6624	159	1200	19	L2C5-57801211F1900
		80	5598	6220	149	1200	19	L2C5-57801211E1900
	2200K <sup>[5]</sup>	90	3749	4165	100	1200	19	L2C5-22901211E1900
	2700K	90	4744	5213	125	1200	19	L2C5-27901211F1900
		90	4305	4783	115	1200	19	L2C5-27901211E1900
	3000K	90	4964	5455	131	1200	19	L2C5-30901211F1900
		90	4505	5005	120	1200	19	L2C5-30901211E1900
	3500K	90	5176	5688	136	1200	19	L2C5-35901211F1900
90		4696	5218	125	1200	19	L2C5-35901211E1900	
4000K	90	5315	5840	141	1200	19	L2C5-40901211F1900	
	90	4822	5358	129	1200	19	L2C5-40901211E1900	
2700K	95	4032	4480	107	1200	19	L2C5-27951211F1900	
3000K	95	4221	4690	112	1200	19	L2C5-30951211F1900	

Notes:

1. Lumileds maintains a tolerance of ±2 on CRI and ±6.5% on luminous flux measurements.
2. Typical CRI is approximately 2 points higher than the minimum CRI specified, but this is not guaranteed.
3. R9 value of 90CRI products is >50.
4. Light Emitting Surface (LES) is the inner diameter (phosphor area) inside the dam.
5. AtmoSphere Technology creates the ideal ambiance for restaurants and other hospitality venues.

Table 1. Product performance of LUXEON CoB Core Range at specified test current, T<sub>j</sub>=85°C (continued).

PRODUCT	NOMINAL CCT	MINIMUM CRI <sup>[1, 2, 3]</sup>	LUMINOUS FLUX <sup>[1]</sup> (lm)		TYPICAL LUMINOUS EFFICACY (lm/W)	TEST CURRENT (mA)	LES <sup>[4]</sup> (mm)	PART NUMBER
			MINIMUM	TYPICAL				
LUXEON CoB 1216	3000K	70	7987	8875	161	1600	23	L2C5-30701216F2300
		70	7465	8294	150	1600	23	L2C5-30701216E2300
	3500K	70	7465	8294	150	1600	23	L2C5-35701216E2300
	4000K	70	8427	9364	170	1600	23	L2C5-40701216F2300
		70	7876	8751	159	1600	23	L2C5-40701216E2300
	5000K	70	8427	9364	170	1600	23	L2C5-50701216F2300
		70	7876	8751	159	1600	23	L2C5-50701216E2300
	5700K	70	8250	9167	166	1600	23	L2C5-57701216F2300
		70	7710	8567	155	1600	23	L2C5-57701216E2300
	6500K	70	8038	8931	162	1600	23	L2C5-65701216F2300
		70	7512	8347	151	1600	23	L2C5-65701216E2300
	2200K	80	5755	6394	116	1600	23	L2C5-22801216E2300
	2700K	80	7334	8150	148	1600	23	L2C5-27801216F2300
		80	6791	7546	137	1600	23	L2C5-27801216E2300
	3000K	80	7508	8342	151	1600	23	L2C5-30801216F2300
		80	6952	7724	140	1600	23	L2C5-30801216E2300
	3500K	80	7657	8508	154	1600	23	L2C5-35801216F2300
		80	7090	7878	143	1600	23	L2C5-35801216E2300
	4000K	80	7947	8830	160	1600	23	L2C5-40801216F2300
		80	7358	8176	148	1600	23	L2C5-40801216E2300
	5000K	80	7947	8830	160	1600	23	L2C5-50801216F2300
		80	7358	8176	148	1600	23	L2C5-50801216E2300
	5700K	80	7923	8803	160	1600	23	L2C5-57801216F2300
		80	7336	8151	148	1600	23	L2C5-57801216E2300
	2200K <sup>[5]</sup>	90	5013	5570	101	1600	23	L2C5-22901216E2300
	2700K	90	6319	7021	127	1600	23	L2C5-27901216F2300
		90	5642	6269	114	1600	23	L2C5-27901216E2300
	3000K	90	6570	7300	132	1600	23	L2C5-30901216F2300
		90	5866	6518	118	1600	23	L2C5-30901216E2300
	3500K	90	6155	6839	124	1600	23	L2C5-35901216E2300
4000K	90	6321	7023	127	1600	23	L2C5-40901216E2300	
LUXEON CoB 1812	4000K	70	9356	10395	168	1200	23	L2C5-40701812F2300
		70	9000	10000	161	1200	23	L2C5-40701812G2300
	5000K	70	9450	10500	169	1200	23	L2C5-50701812F2300
		70	9000	10000	161	1200	23	L2C5-50701812G2300
	3000K	80	8221	9134	147	1200	23	L2C5-30801812F2300
		80	7682	8536	138	1200	23	L2C5-30801812G2300
	4000K	80	8691	9657	156	1200	23	L2C5-40801812F2300
		80	8122	9025	145	1200	23	L2C5-40801812G2300
	5000K	80	8814	9793	158	1200	23	L2C5-50801812F2300
		80	8122	9025	145	1200	23	L2C5-50801812G2300

Notes:

1. Lumileds maintains a tolerance of ±2 on CRI and ±6.5% on luminous flux measurements.
2. Typical CRI is approximately 2 points higher than the minimum CRI specified, but this is not guaranteed.
3. R9 value of 90CRI products is >50.
4. Light Emitting Surface (LES) is the inner diameter (phosphor area) inside the dam.
5. AtmoSphere Technology creates the ideal ambiance for restaurants and other hospitality venues.

Table 1. Product performance of LUXEON CoB Core Range at specified test current, T<sub>j</sub>=85°C (continued).

PRODUCT	NOMINAL CCT	MINIMUM CRI <sup>[1, 2, 3]</sup>	LUMINOUS FLUX <sup>[1]</sup> (lm)		TYPICAL LUMINOUS EFFICACY (lm/W)	TEST CURRENT (mA)	LES <sup>[4]</sup> (mm)	PART NUMBER
			MINIMUM	TYPICAL				
LUXEON CoB 1321	2200K	60	10961	12179	155	2100	29	L2C5-22601321F2900
	3000K	70	10736	11929	151	2100	29	L2C5-30701321E2900
	4000K	70	11866	13185	167	2100	29	L2C5-40701321F2900
		70	11416	12684	161	2100	29	L2C5-40701321E2900
	5000K	70	11986	13318	169	2100	29	L2C5-50701321F2900
		70	11416	12684	161	2100	29	L2C5-50701321E2900
	5700K	70	11121	12357	157	2100	29	L2C5-57701321E2900
	6500K	70	10834	12038	153	2100	29	L2C5-65701321E2900
	2700K	80	9797	10885	138	2100	29	L2C5-27801321E2900
	3000K	80	10737	11930	151	2100	29	L2C5-30801321F2900
		80	10035	11150	142	2100	29	L2C5-30801321E2900
	3500K	80	10238	11376	144	2100	29	L2C5-35801321E2900
	4000K	80	11352	12613	160	2100	29	L2C5-40801321F2900
		80	10610	11788	150	2100	29	L2C5-40801321E2900
	5000K	80	10610	11788	150	2100	29	L2C5-50801321E2900
	2700K	90	8136	9040	115	2100	29	L2C5-27901321E2900
	3000K	90	8409	9344	119	2100	29	L2C5-30901321E2900
	5600K	90	9117	10130	129	2100	29	L2C5-56901321E2900
LUXEON CoB 1825	2200K	60	15120	16800	144	2250	32	L2C5-22601825G3200
	3000K	70	15550	17278	151	2250	32	L2C5-30701825G3200
	4000K	70	17362	19291	166	2250	32	L2C5-40701825F3200
		70	16535	18372	161	2250	32	L2C5-40701825G3200
	5000K	70	17362	19291	166	2250	32	L2C5-50701825F3200
		70	16535	18372	161	2250	32	L2C5-50701825G3200
	5700K	70	16108	17898	157	2250	32	L2C5-57701825G3200
	6500K	70	15692	17436	153	2250	32	L2C5-65701825G3200
	2700K	80	14190	15767	138	2250	32	L2C5-27801825G3200
	3000K	80	15553	17281	149	2250	32	L2C5-30801825F3200
		80	14535	16150	138	2250	32	L2C5-30801825G3200
	3500K	80	14829	16477	144	2250	32	L2C5-35801825G3200
	4000K	80	16443	18270	157	2250	32	L2C5-40801825F3200
		80	15367	17075	150	2250	32	L2C5-40801825G3200
	5000K	80	15367	17075	150	2250	32	L2C5-50801825G3200
	2700K	90	11784	13094	115	2250	32	L2C5-27901825G3200
	3000K	90	12180	13534	119	2250	32	L2C5-30901825G3200
	5600K	90	13205	14673	129	2250	32	L2C5-56901825G3200

Notes for Table 1:

1. Lumileds maintains a tolerance of ±2 on CRI and ±6.5% on luminous flux measurements.
2. Typical CRI is approximately 2 points higher than the minimum CRI specified, but this is not guaranteed.
3. R9 value of 90CRI products is >50.
4. Light Emitting Surface (LES) is the inner diameter (phosphor area) inside the dam.
5. AtmoSphere Technology creates the ideal ambiance for restaurants and other hospitality venues.

# Optical Characteristics

Table 2. Optical characteristics for LUXEON CoB Core Range at specified test current,  $T_j=85^\circ\text{C}$ .

PART NUMBER	TYPICAL TOTAL INCLUDED ANGLE <sup>[1]</sup>	TYPICAL VIEWING ANGLE <sup>[2]</sup>
L2C5-xxxx12xxxx00	135°	115°

**Notes for Table 2:**

1. Total angle at which 90% of total luminous flux is captured.
2. Viewing angle is the off axis angle from the LED centerline where the luminous intensity is ½ of the peak value.

# Electrical and Thermal Characteristics

Table 3. Electrical and thermal characteristics for LUXEON CoB Core Range at specified test current,  $T_j=85^\circ\text{C}$ .

PART NUMBER	FORWARD VOLTAGE <sup>[1]</sup> (V <sub>f</sub> )			TYPICAL TEMPERATURE COEFFICIENT OF FORWARD VOLTAGE <sup>[2]</sup> (mV/°C)	TYPICAL THERMAL RESISTANCE—JUNCTION TO CASE <sup>[3]</sup> (°C/W)
	MINIMUM	TYPICAL	MAXIMUM		
L2C5-xxxx1202E0600	32.5	34.5	37.5	-16	0.98
L2C5-xxxx1202E0900	32.5	34.5	37.5	-16	0.98
L2C5-xxxx1203F0900	32.5	34.5	37.5	-16	0.62
L2C5-xxxx1203E0900	32.5	34.5	37.5	-16	0.70
L2C5-xxxx1204F1300	32.5	34.8	37.5	-16	0.46
L2C5-xxxx1204E1300	32.5	34.8	37.5	-16	0.55
L2C5-xxxx1205F1300	32.5	35.0	37.5	-16	0.37
L2C5-xxxx1205E1300	32.5	35.0	37.5	-16	0.51
L2C5-xxxx1208F1500	32.5	34.8	37.5	-16	0.25
L2C5-xxxx1208E1500	32.5	34.8	37.5	-16	0.29
L2C5-xxxx1211F1900	32.5	34.8	37.5	-16	0.18
L2C5-xxxx1211E1900	32.5	34.8	37.5	-16	0.23
L2C5-xxxx1216F2300	32.5	34.5	37.5	-16	0.13
L2C5-xxxx1216E2300	32.5	34.5	37.5	-16	0.14
L2C5-xxxx1812F2300	48.8	51.7	56.3	-16	0.12
L2C5-xxxx1812G2300	48.8	51.7	56.3	-16	0.12
L2C5-xxxx1321F2900	35.2	37.5	40.6	-16	0.08
L2C5-xxxx1321E2900	35.2	37.5	40.6	-16	0.08
L2C5-xxxx1825F3200	48.8	51.7	56.3	-16	0.05
L2C5-xxxx1825G3200	48.8	51.7	56.3	-16	0.05

**Notes for Table 3:**

1. Lumileds maintains a tolerance of ±2% on forward voltage measurements.
2. Measured between 25°C and 85°C.
3. Thermal resistance is measured between junction and the bottom of the LUXEON CoB substrate.

# Absolute Maximum Ratings

Table 4. Absolute maximum ratings for LUXEON CoB Core Range.

PARAMETER	MAXIMUM PERFORMANCE
DC Forward Current <sup>[1,2]</sup>	2x test current <sup>[3]</sup>
LED Junction Temperature <sup>[1]</sup> (DC & Pulse)	125°C
ESD Sensitivity (ANSI/ESDA/JEDEC JS-001-2012)	Class 3B
Operating Case Temperature <sup>[1]</sup>	-40°C to 105°C
LED Storage Temperature	-40°C to 120°C
Allowable Reflow Cycles	3
Reverse Voltage ( $V_{reverse}$ )	LUXEON LEDs are not designed to be driven in reverse bias

**Notes for Table 4:**

1. Proper current derating must be observed to maintain the junction temperature below the maximum allowable junction temperature.
2. Residual periodic variations due to power conversion from alternating current (AC) to direct current (DC), also called "ripple," are acceptable if the following conditions are met:
  - The frequency of the ripple current is 100Hz or higher
  - The average current for each cycle does not exceed the maximum allowable DC forward current
  - The maximum amplitude of the ripple does not exceed 20% of the maximum allowable DC forward current
3. Exception: LUXEON CoB 1812 has a maximum DC forward current of 2.1A (1.75x test current).

# Characteristic Curves

## Spectral Power Distribution Characteristics

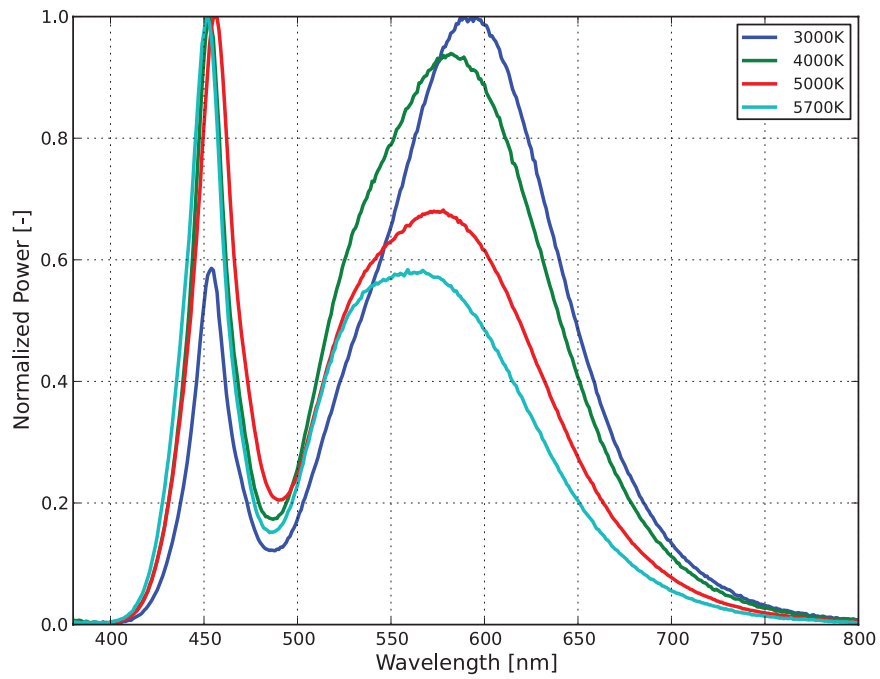

Figure 1a. Typical normalized power vs. wavelength for L2C5-xx7012xxxxx00 at specified test current,  $T_j=85^{\circ}\text{C}$ .

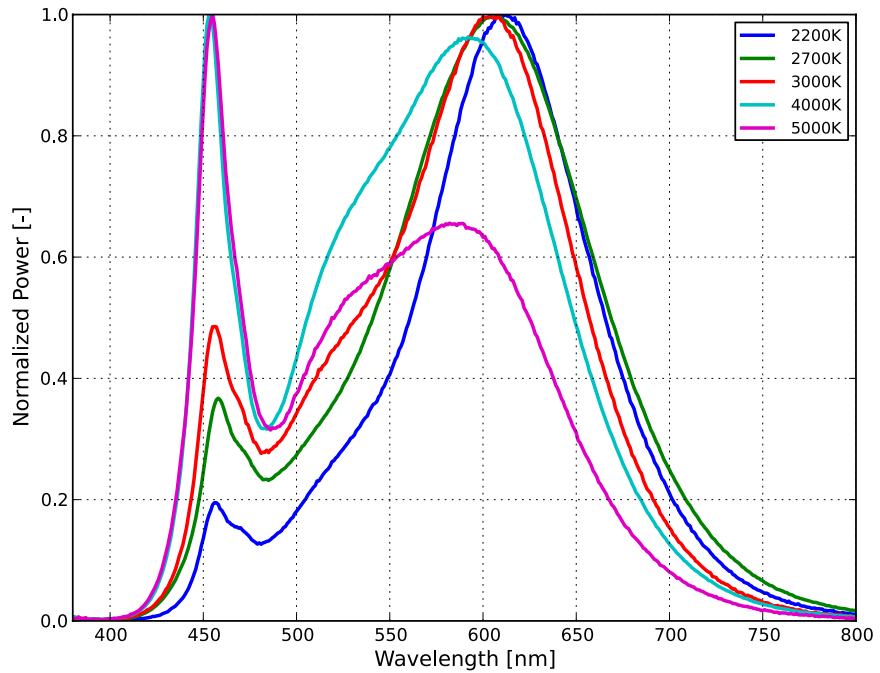

Figure 1b. Typical normalized power vs. wavelength for L2C5-xx8012xxxxx00 at specified test current,  $T_j=85^{\circ}\text{C}$ .

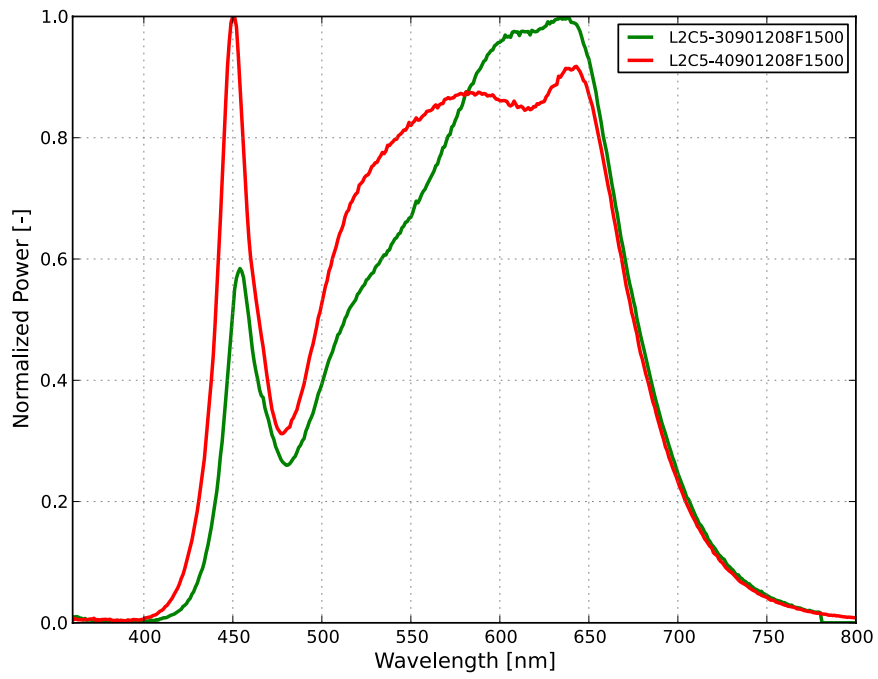

Figure 1c. Typical normalized power vs. wavelength for L2C5-xx9012xxFxx00 at specified test current,  $T_j=85^\circ\text{C}$ .

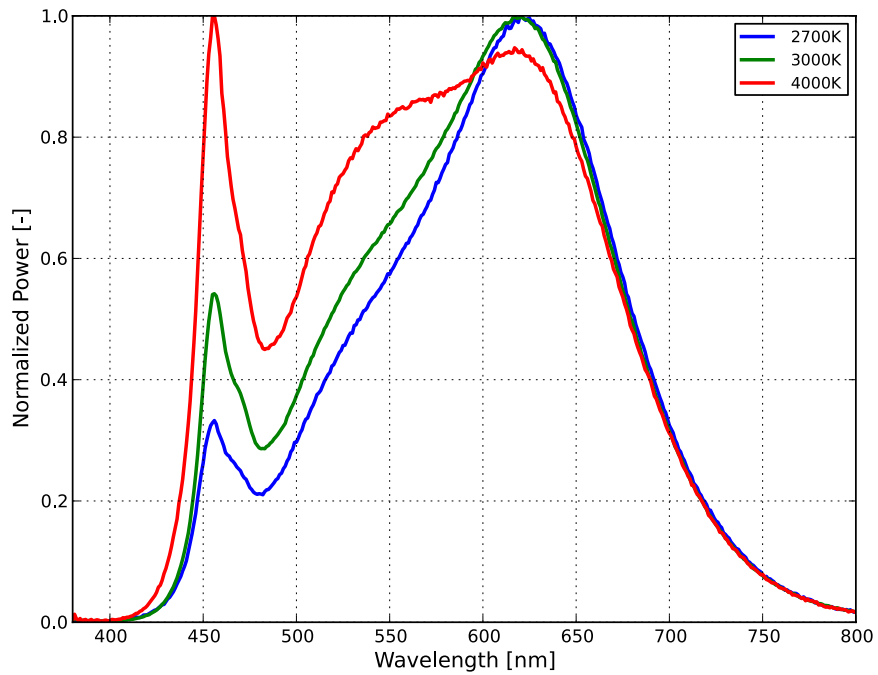

Figure 1d. Typical normalized power vs. wavelength for L2C5-xx9012xxExx00 at specified test current,  $T_j=85^\circ\text{C}$ .

# Light Output Characteristics

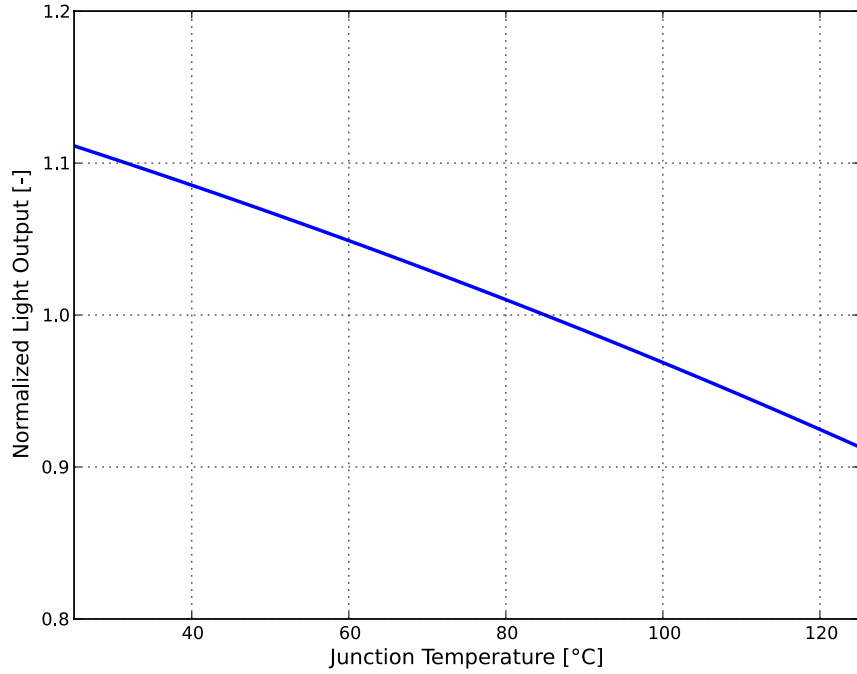

Figure 2. Typical normalized light output vs. junction temperature for L2C5-xxxx12xxxx00 at specified test current.

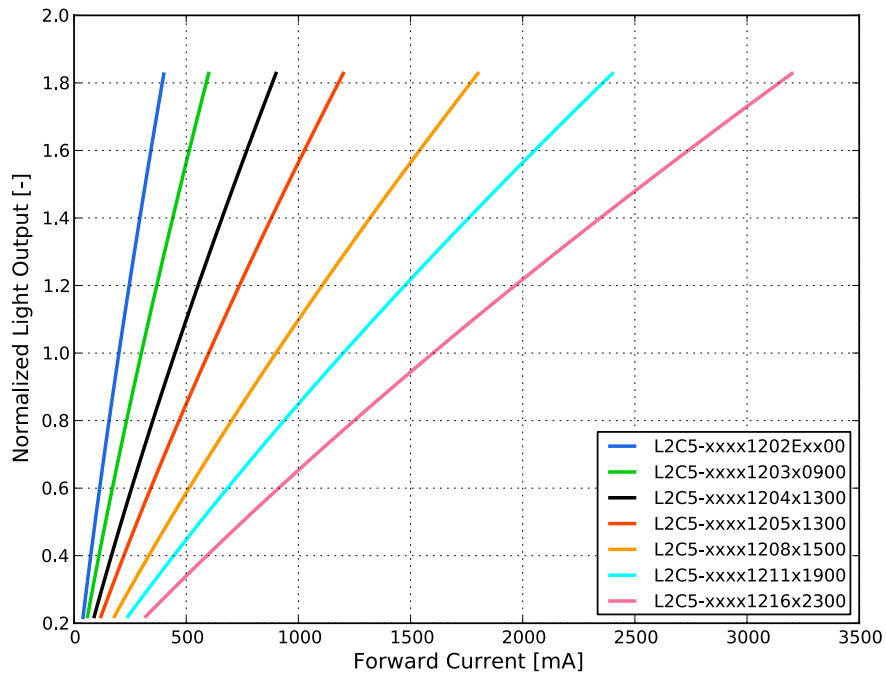

Figure 3a. Typical normalized light output vs. forward current for L2C5-xxxx12xxxx00 at T<sub>j</sub>=85°C.



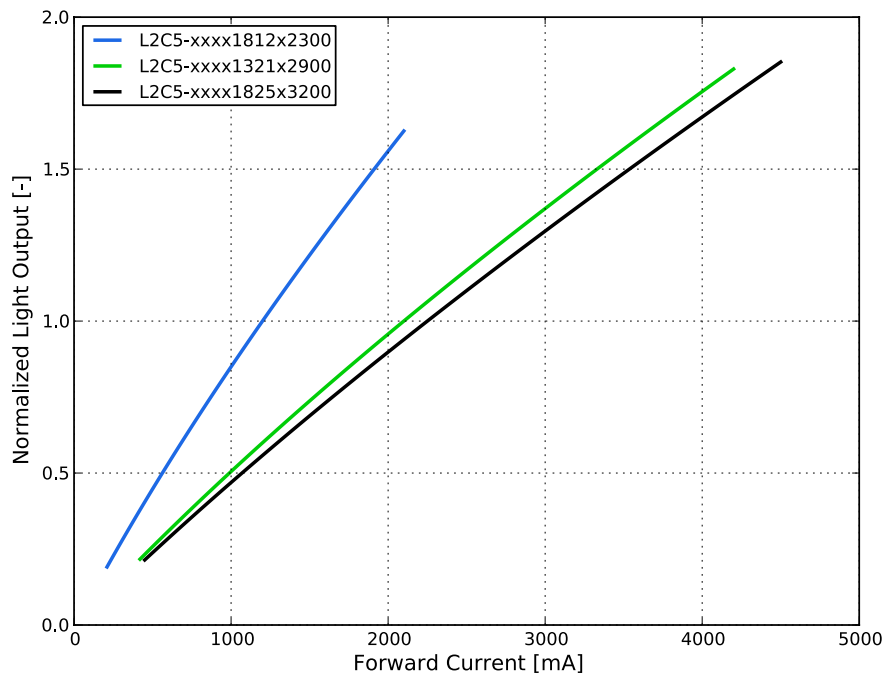

Figure 3b. Typical normalized light output vs. forward current for L2C5-xxxx1812xxx00, L2C5-xxxx1321xxx00, and L2C5-xxxx1825xxx00 at  $T_j=85^\circ\text{C}$ .

## Forward Current Characteristics

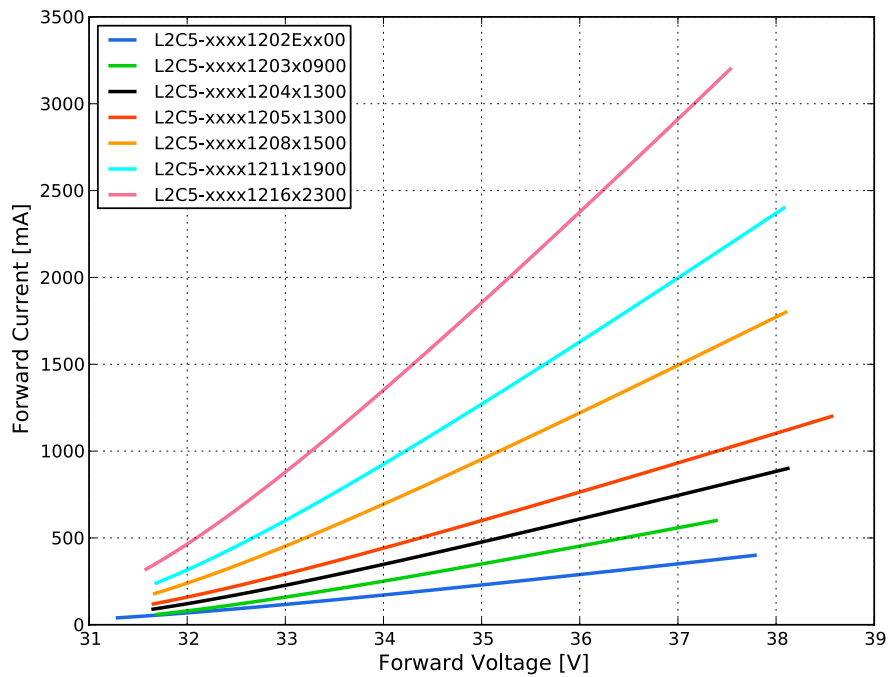

Figure 4a. Typical forward current vs. forward voltage for L2C5-xxxx12xxxxx00 at  $T_j=85^\circ\text{C}$ .

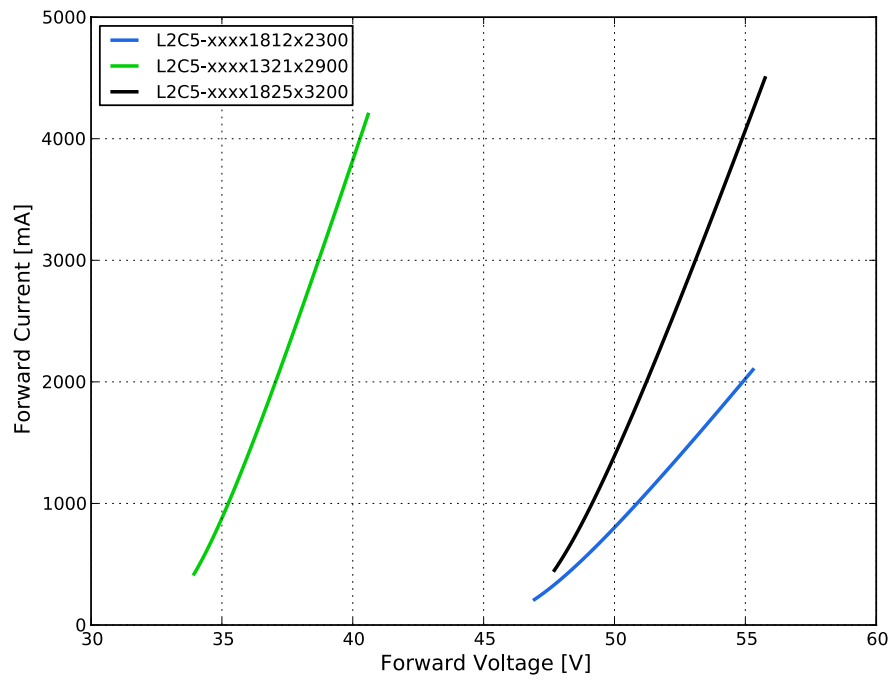

Figure 4b. Typical forward current vs. forward voltage for L2C5-xxxx1812xxx00, L2C5-xxxx1321xxx00, and L2C5-xxxx1825xxx00 at  $T_j=85^\circ\text{C}$ .

# Radiation Pattern Characteristics



Figure 5. Typical radiation pattern for LUXEON CoB Core Range at specified test current,  $T_j=85^{\circ}\text{C}$ .

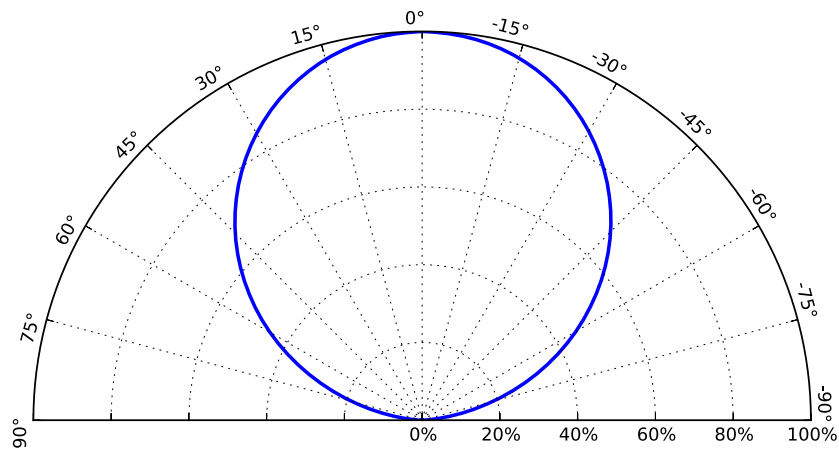

Figure 6. Typical polar radiation pattern for LUXEON CoB Core Range at specified test current,  $T_j=85^{\circ}\text{C}$ .

# Color Bin Definitions

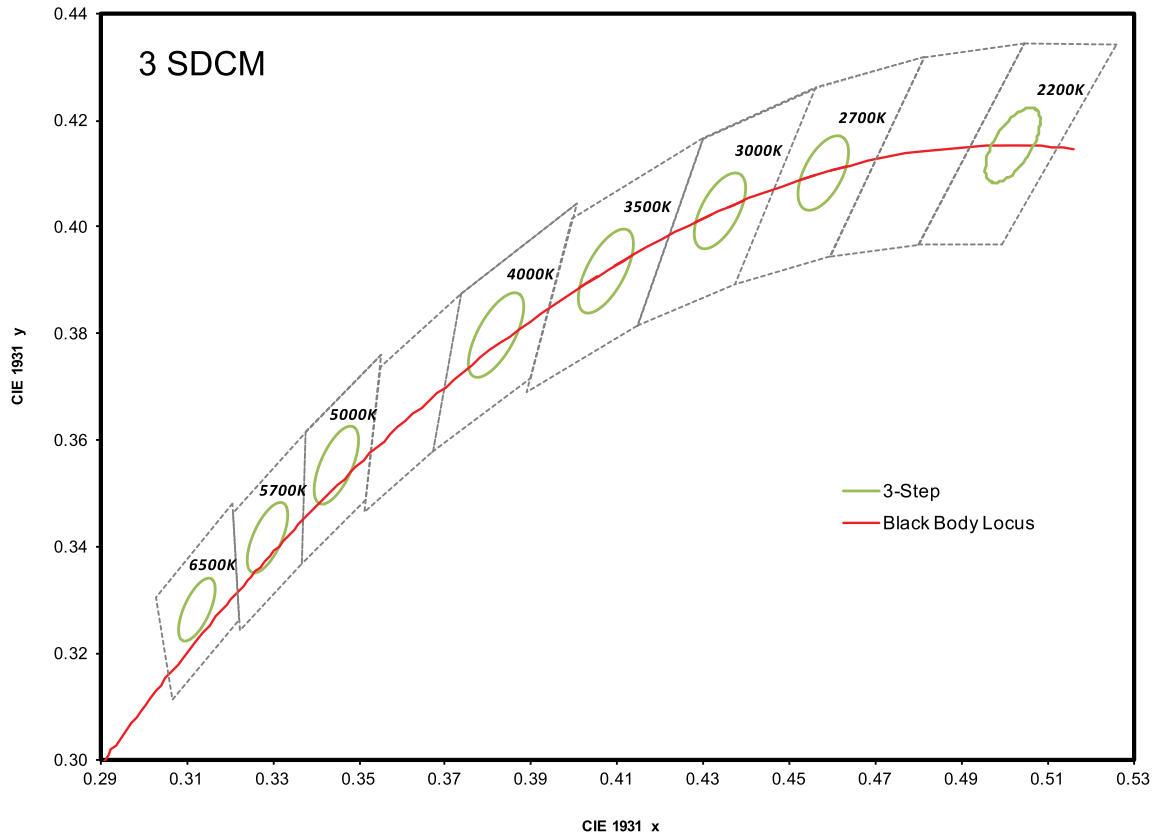

Figure 7. 3-step MacAdam ellipse illustration for Table 5.

Table 5. 3-step MacAdam ellipse color bin definitions for LUXEON CoB Core Range.

NOMINAL CCT	COLOR SPACE	CENTER POINT <sup>(1)</sup> (cx, cy)	MAJOR AXIS, a	MINOR AXIS, b	ELLIPSE ROTATION ANGLE, $\theta$
2200K	Single 3-step MacAdam ellipse	(0.5020, 0.4155)	0.00862	0.00397	49.30°
2700K	Single 3-step MacAdam ellipse	(0.4578, 0.4101)	0.00810	0.00420	53.70°
3000K	Single 3-step MacAdam ellipse	(0.4338, 0.4030)	0.00834	0.00408	53.20°
3500K	Single 3-step MacAdam ellipse	(0.4073, 0.3917)	0.00927	0.00414	54.00°
4000K	Single 3-step MacAdam ellipse	(0.3818, 0.3797)	0.00939	0.00402	53.70°
5000K	Single 3-step MacAdam ellipse	(0.3447, 0.3553)	0.00822	0.00354	59.60°
5600K	Single 3-step MacAdam ellipse	(0.3293, 0.3423)	0.00745	0.00320	59.10°
5700K	Single 3-step MacAdam ellipse	(0.3287, 0.3417)	0.00745	0.00320	59.09°
6500K	Single 3-step MacAdam ellipse	(0.3123, 0.3282)	0.00669	0.00285	58.57°

**Notes for Table 5:**

1. Lumileds maintains a tolerance of  $\pm 0.005$  on x and y coordinates in the CIE 1931 color space.

# Mechanical Dimensions

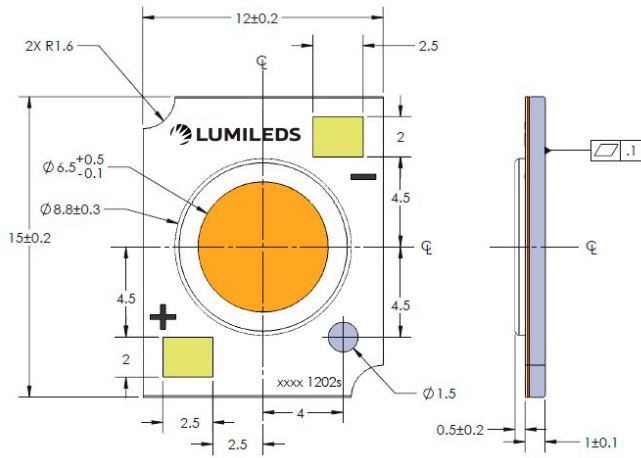

L2C5-xxxx1202E0600

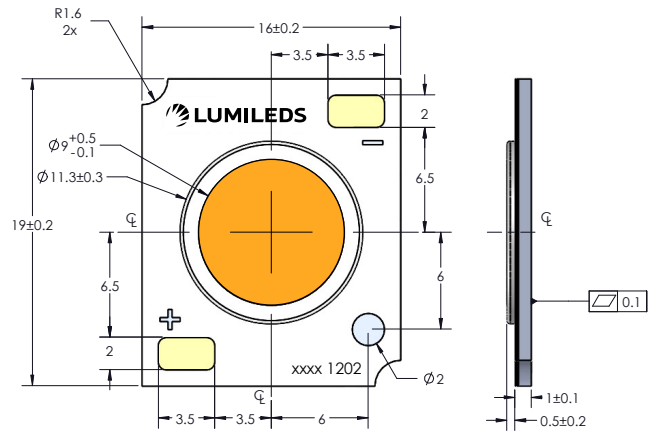

L2C5-xxxx1202E0900

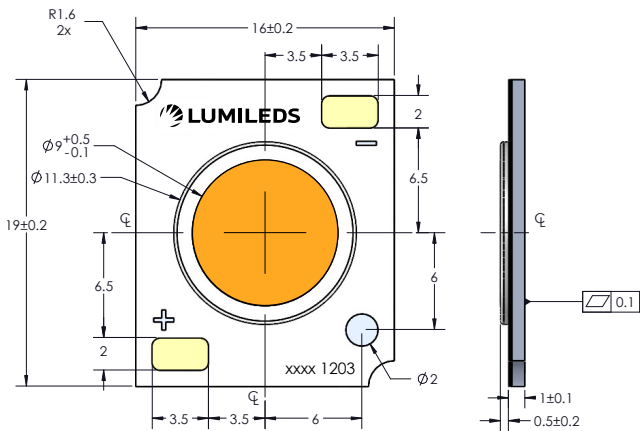

L2C5-xxxx1203x0900

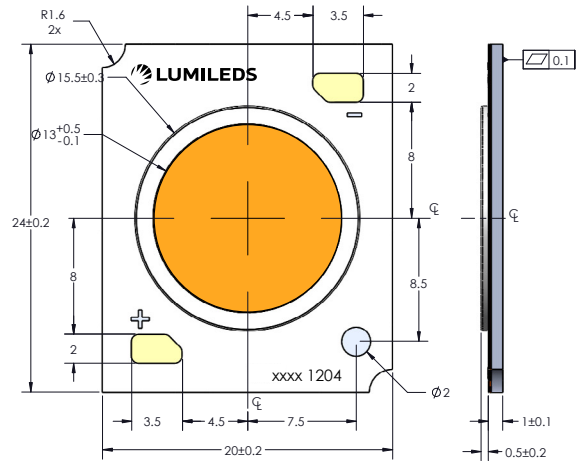

L2C5-xxxx1204x1300

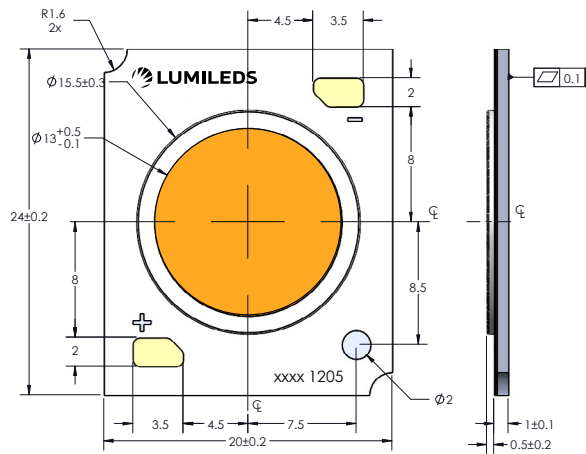

L2C5-xxxx1205x1300

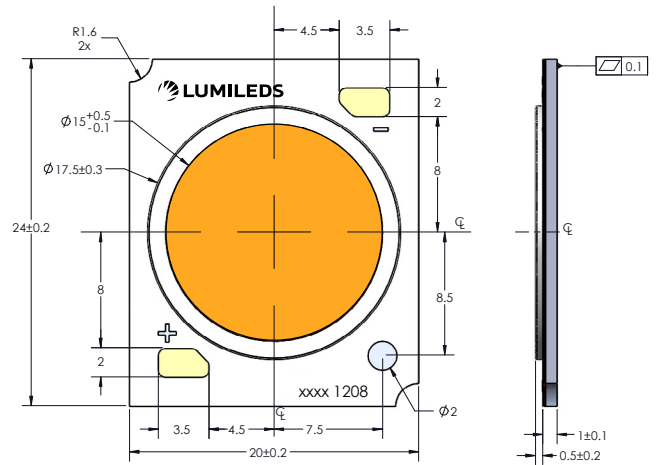

L2C5-xxxx1208x1500

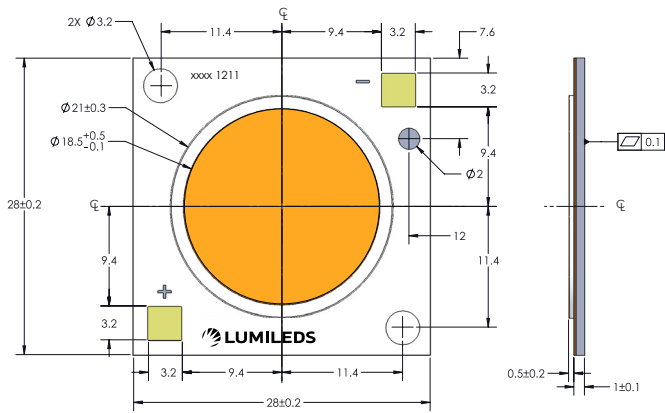

L2C5-xxxx1211x1900

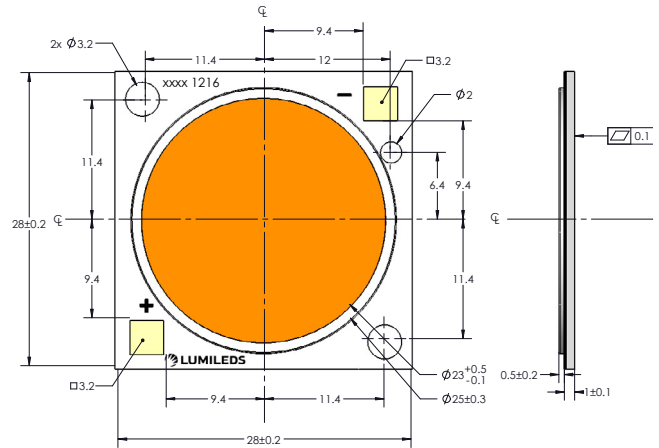

L2C5-xxxx1216x2300 and L2C5-xxxx1812x2300

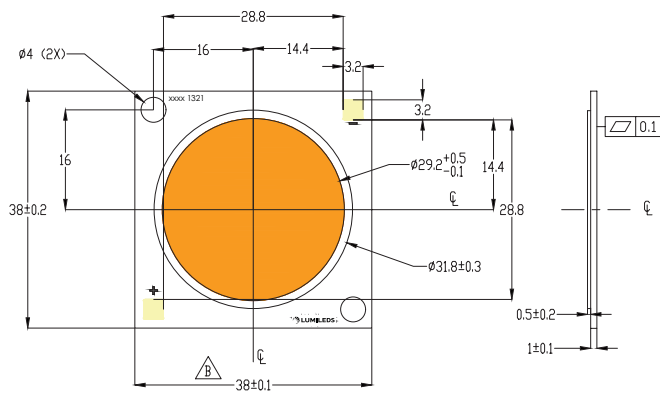

L2C5-xxxx1321x2900

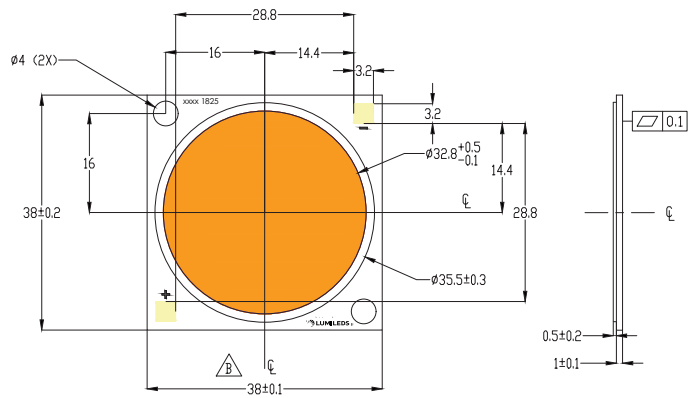

L2C5-xxxx1825x3200

Figure 8. Mechanical dimensions for LUXEON CoB Core Range.

Notes for Figure 8:

1. Drawings not to scale.
2. All dimensions are in millimeters.

# Packaging and Labeling Information

LUXEON CoB Core Range LEDs are packaged in tubes then in a carton box. Each tube contains a specified number of LEDs. The LEDs in each tube come from a single category code, ensuring they are all well-matched for light output, color, and forward voltage. Each tube contains a rubber stopper at one end. The tube label has both alphanumeric and bar code information. The carton boxes have printed information providing part numbers with CAT codes that indicate luminous flux, color and forward voltage bins.

Table 6. Number of LEDs per tube for LUXEON CoB Core Range.

PART NUMBER	TOTAL UNITS PER TUBE	TOTAL TUBES PER INNER BOX	TOTAL UNITS PER INNER BOX
L2C5-xxxx1202E0600	20	5	100
L2C5-xxxx1202E0900	20	5	100
L2C5-xxxx1203x0900	20	5	100
L2C5-xxxx1204x1300	20	5	100
L2C5-xxxx1205x1300	20	5	100
L2C5-xxxx1208x1500	20	5	100
L2C5-xxxx1211x1900	10	5	50
L2C5-xxxx1216x2300	10	5	50
L2C5-xxxx1812x2300	10	5	50
L2C5-xxxx1321x2900	10	5	50
L2C5-xxxx1825x3200	10	5	50

## Tube

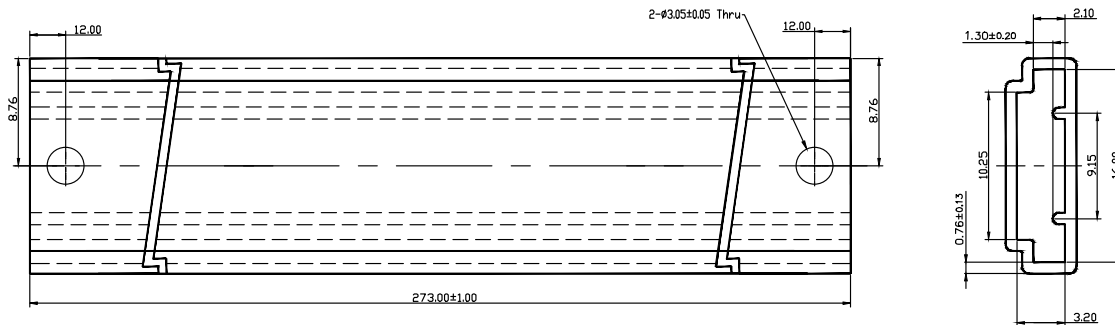

Figure 9a. Tube dimensions for L2C5-xxxx1202E0600.

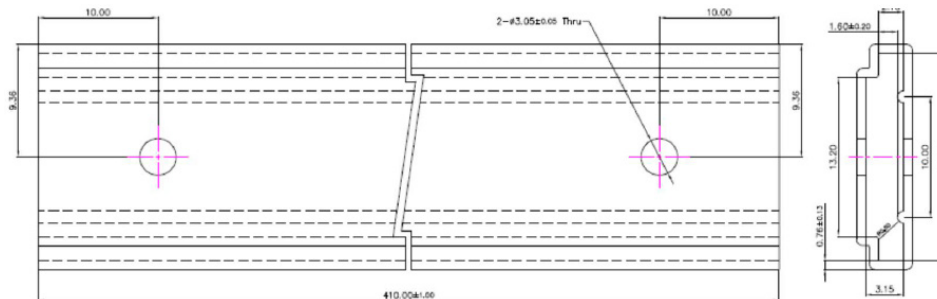

Figure 9b. Tube dimensions for L2C5-xxxx1202E0900.

Notes for Figures 9a and 9b:

1. Drawings not to scale.
2. All dimensions are in millimeters.



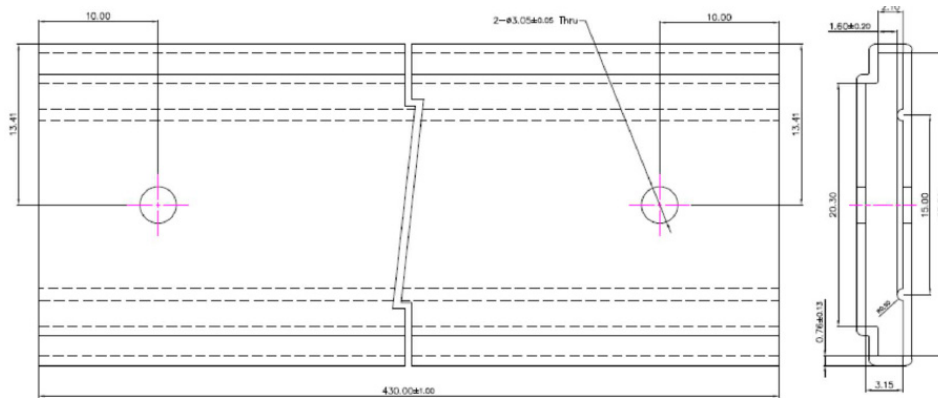

Figure 9c. Tube dimensions for L2C5-xxxx120xx1300 and L2C5-xxxx1208x1500.

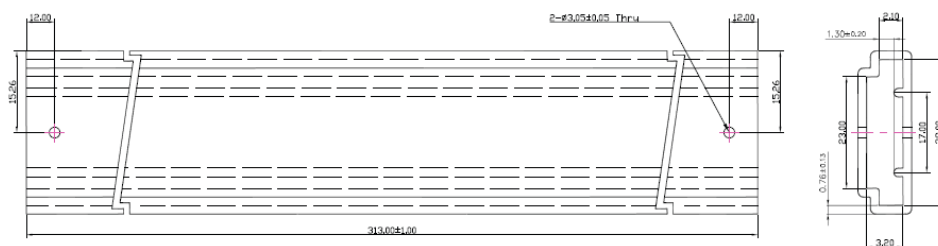

Figure 9d. Tube dimensions for L2C5-xxxx1211x1900, L2C5-xxxx1216x2300 and L2C5-xxxx1812x2300.

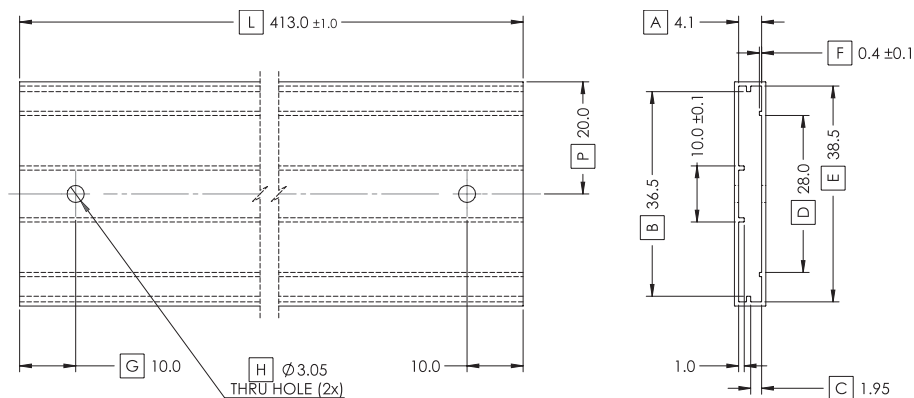

Figure 9e. Tube dimensions for L2C5-xxxx1321x2900 and L2C5-xxxx1825x3200.

Notes for Figures 9c, 9d and 9e:  
 1. Drawings not to scale.  
 2. All dimensions are in millimeters.

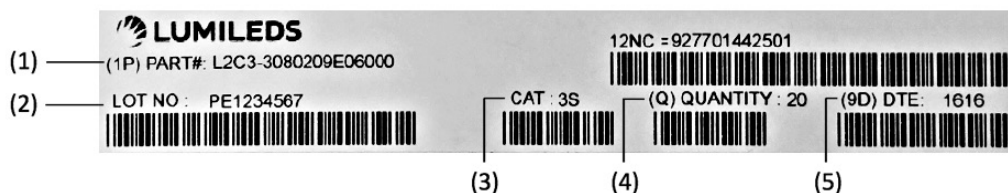

Figure 10. Example of a tube label for LUXEON CoB Core Range.

Notes for Figure 10 - Tube Label descriptions for customer use:  
 Field labels not described are for Lumileds internal use only.  
 1. Lumileds part number.  
 2. Unique production lot identification number. This number is required for traceability purpose.  
 3. Product category code.  
 4. Number of LED emitters in a tube.  
 5. LED test date in YYYY format.

# Inner Box

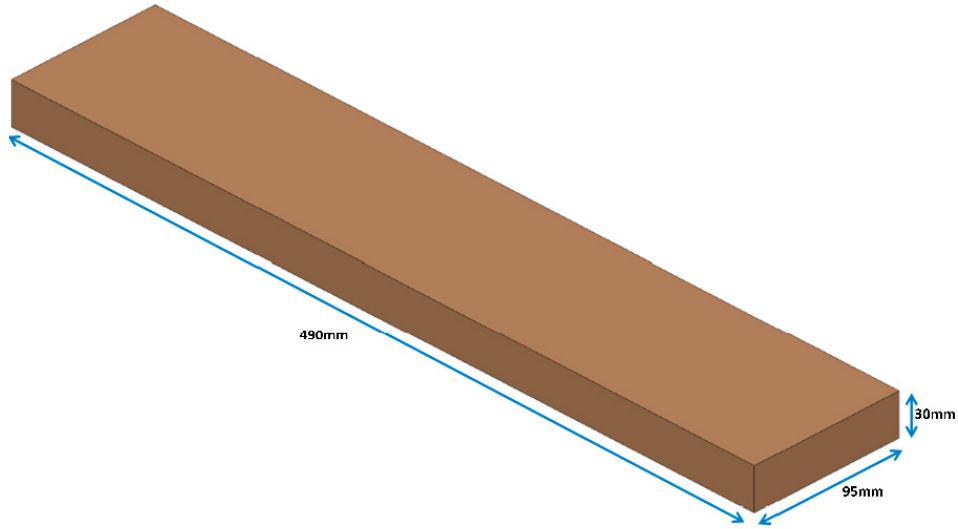

Figure 11. Dimensions for inner box packaging for LUXEON CoB Core Range.

Table 7. Inner box information for LUXEON CoB Core Range.

BOX TYPE	DIMENSIONS (mm)			AVERAGE WEIGHT (100pcs/box)	AVERAGE WEIGHT (100pcs/box)
	H	L	W		
Inner Box	30	490	95	0.340Kg	0.305Kg



Figure 12. Example of inner box label for LUXEON CoB Core Range.

Notes for Figure 12 – Inner Box Label descriptions for customer use:  
Field labels not described are for Lumileds internal use only.

1. Lumileds part number.
2. Number of LED emitters in a box.
3. LED test date in YYWW format.
4. Customer part number for custom requests only.
5. Unique production lot identification number. This number is required for traceability purpose.
6. Product category code.

# Outer Box

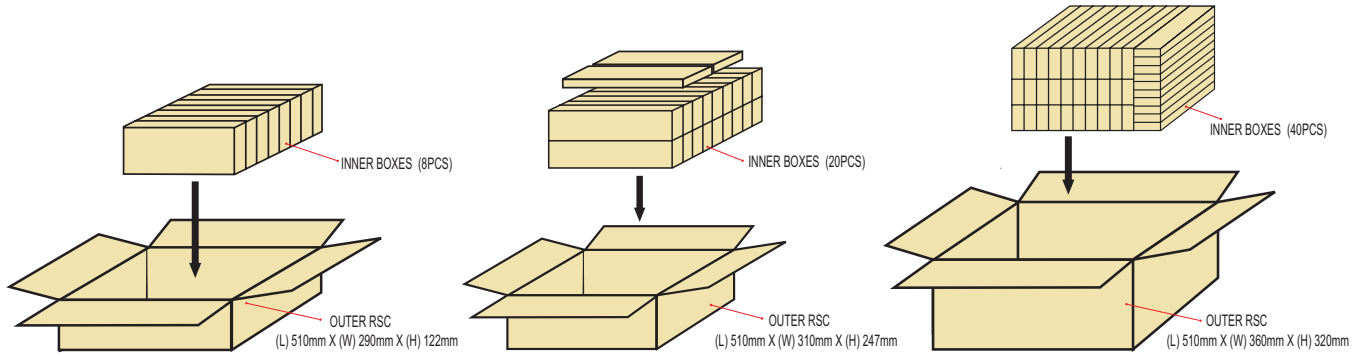

Figure 13. Dimensions for outer box packaging for LUXEON CoB Core Range.

Table 8. Outer box information for LUXEON CoB Core Range.

BOX TYPE	DIMENSIONS (mm)			MAXIMUM INNER BOXES PER OUTER BOX	MAXIMUM QUANTITY PER OUTER BOX	AVERAGE WEIGHT (100pcs/box)	AVERAGE WEIGHT (50pcs/box)
	H	L	W				
Outer Box 8	122	510	290	8	800	3.05kg	2.77kg
Outer Box 20	247	510	310	20	2000	7.55kg	6.85kg
Outer Box 40	320	510	360	40	4000	15.10kg	13.70kg

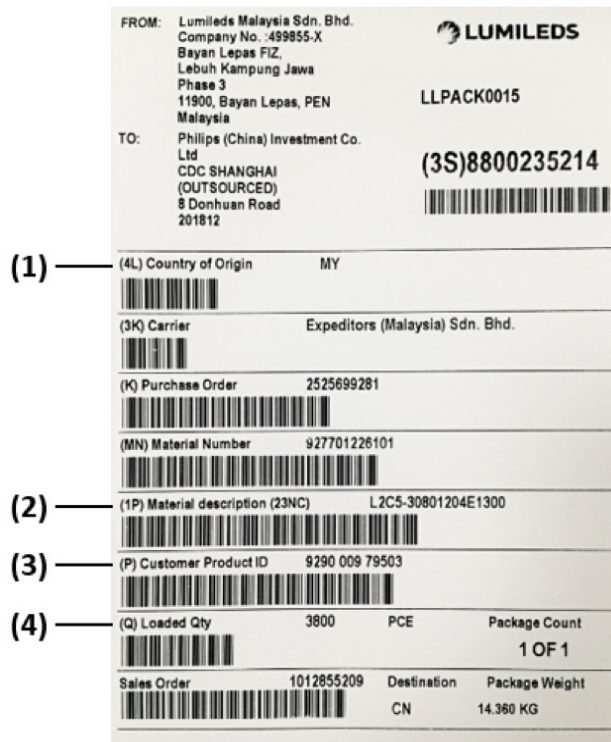

Figure 14. Example of outer box label for LUXEON CoB Core Range.

Notes for Figure 14 – Outer Box Label descriptions for customer use:  
Field labels not described are for Lumileds internal use only.

1. Country code of origin of manufacturing of parts (e.g. MY for Malaysia, CN for China) according to ISO 3166-1 alpha-2 document.
2. Lumileds part number.
3. Customer part number for custom requests only.
4. Total number of LED emitters in a shipment box.

## About Lumileds

Companies developing automotive, mobile, IoT and illumination lighting applications need a partner who can collaborate with them to push the boundaries of light. With over 100 years of inventions and industry firsts, Lumileds is a global lighting solutions company that helps customers around the world deliver differentiated solutions to gain and maintain a competitive edge. As the inventor of Xenon technology, a pioneer in halogen lighting and the leader in high performance LEDs, Lumileds builds innovation, quality and reliability into its technology, products and every customer engagement. Together with its customers, Lumileds is making the world better, safer, more beautiful—with light.

To learn more about our lighting solutions, visit [lumileds.com](http://lumileds.com).



©2020 Lumileds Holding B.V. All rights reserved.  
LUXEON is a registered trademark of the Lumileds Holding B.V. in the United States and other countries.

[lumileds.com](http://lumileds.com)

Neither Lumileds Holding B.V. nor its affiliates shall be liable for any kind of loss of data or any other damages, direct, indirect or consequential, resulting from the use of the provided information and data. Although Lumileds Holding B.V. and/or its affiliates have attempted to provide the most accurate information and data, the materials and services information and data are provided "as is," and neither Lumileds Holding B.V. nor its affiliates warrants or guarantees the contents and correctness of the provided information and data. Lumileds Holding B.V. and its affiliates reserve the right to make changes without notice. You as user agree to this disclaimer and user agreement with the download or use of the provided materials, information and data. A listing of Lumileds product/patent coverage may be accessed at [lumileds.com/patents](http://lumileds.com/patents).