

SPL S1L90A_3 A01

SMT Laser

1 Channel SMT Laser in QFN package

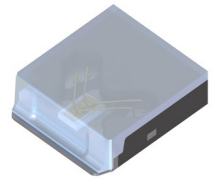

Applications

- 3D Sensing
- CCTV Surveillance
- Industrial Automation (Machine Controls, Light Barriers, Vision Controls)
- LIDAR, Pre-Crash, ACC
- Measurement Levelling

Features:

- Qualifications: The product qualification test plan is based on the guidelines of AEC-Q102, failure mechanism based Stress Test Qualification for Discrete Optoelectronic Semiconductors in Automotive applications.
- Laser wavelength 905 nm
- 1 channel pulsed laser module
- Suited for short laser pulses from 1 to 100 ns
- SMT device

Ordering Information

Type	Peak output power typ. P_{opt}	Ordering Code
SPL S1L90A_3 A01	120 W	Q65112A6166

Preliminary datasheet version

Maximum Ratings

$T_s = 25\text{ °C}$

Parameter	Symbol	Values
Operating temperature	T_{op}	min. -40 °C max. 105 °C
Storage temperature	T_{stg}	min. -40 °C max. 125 °C
Junction temperature	T_j	max. 125 °C
Output power	P_{opt}	max. 0.24 W
Forward current dc = 0.2 %	I_F	max. 40 A
Pulse width (FWHM)	t_p	max. 100 ns
Duty cycle	dc	max. 0.2 %
Reverse voltage ¹⁾	V_R	max. 45 V

Characteristics

$I_F = 40 \text{ A}$; $t_p = 100 \text{ ns}$; $D = 0.01 \%$; $T_s = 25 \text{ °C}$

Parameter	Symbol		Values
Number of channels	N	typ.	1
Operating voltage	V_{op}	typ.	11 V
Centroid wavelength	$\lambda_{centroid}$	min. typ. max.	895 nm 905 nm 915 nm
Spectral bandwidth (FWHM)	$\Delta\lambda$	min. typ. max.	3 nm 7 nm 12 nm
Peak output power	P_{opt}	min. typ. max.	105 W 125 W 145 W
Beam divergence (FWHM) parallel to pn-junction	$\Theta_{ }$	min. typ. max.	3 ° 10 ° 13 °
Beam divergence (FWHM) perpendicular to pn-junction	Θ_{\perp}	min. typ. max.	20 ° 25 ° 30 °
Beam divergence (1/e ²) parallel to pn-junction	$\Theta_{ }$	min. typ. max.	10 ° 13 ° 16 °
Beam divergence (1/e ²) perpendicular to pn-junction	Θ_{\perp}	min. typ. max.	35 ° 40 ° 50 °
Threshold current	I_{th}	typ.	0.6 A
Laser aperture (FWHM) parallel to pn-junction	$W_{ }$	typ.	220 μm
Laser aperture (FWHM) perpendicular to pn-junction	W_{\perp}	typ.	10 μm
Thermal resistance junction solder point real ²⁾	$R_{thJS real}$	typ. max.	31 K / W 36 K / W

Relative Spectral Emission ^{3), 4)}

$$I_{rel} = f(\lambda); I_F = 40A; P_{opt} = 125W; t_p = 100ns; D = 0.01\%$$

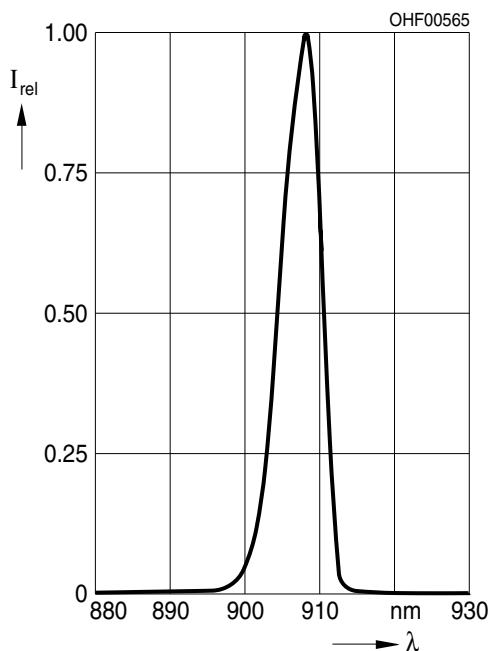

Far-Field Distribution Perpendicular to pn-Junction ^{3), 4)}

$$I_{rel} = f(\Theta_{\perp}); P_{opt} = 125W; t_p = 100ns; D = 0.01\%$$

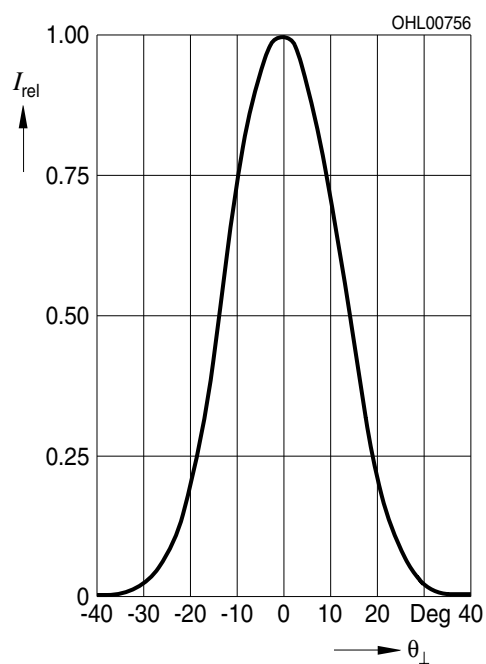

Far-Field Distribution Parallel to pn-Junction ^{3), 4)}

$I_{rel} = f(\Theta_{||})$; $P_{opt} = 125W$; $t_p = 100ns$; $D = 0.01\%$

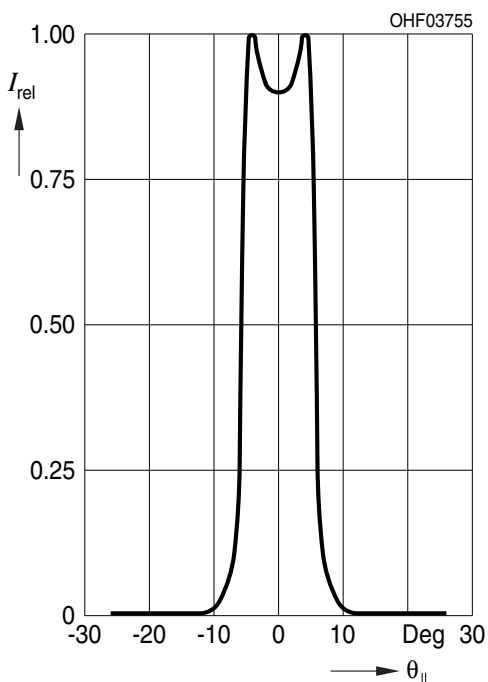

Near-Field Distribution Parallel to pn-Junction ^{3), 4)}

$I_{rel} = f(\Theta_{||})$; $P_{opt} = 125W$; $t_p = 100ns$; $D = 0.01\%$

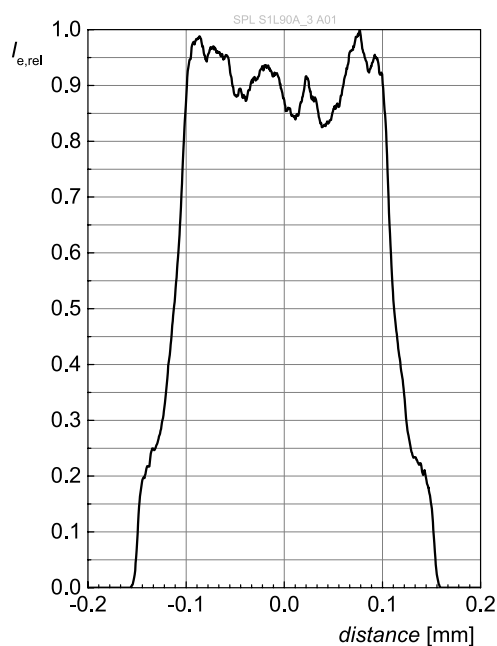

Near-Field Distribution Perpendicular to pn-Junction ^{3), 4)}

$$I_{rel} = f(\Theta_{\perp}); P_{opt} = 125W; t_p = 100ns; D = 0.01\%$$

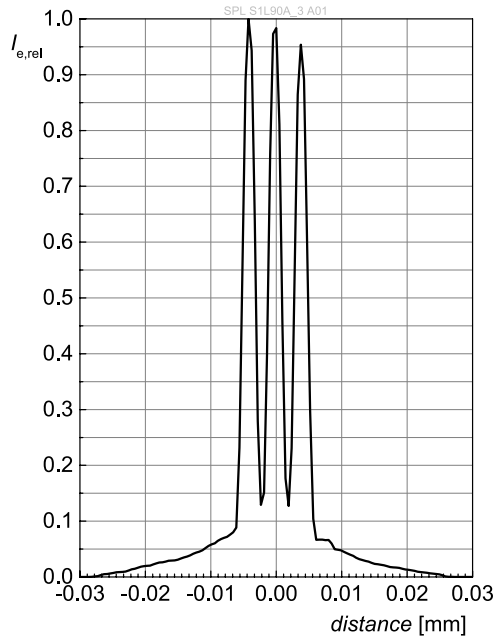

Optical Output Power ^{3), 4)}

$$P_{opt} = f(I_F)$$

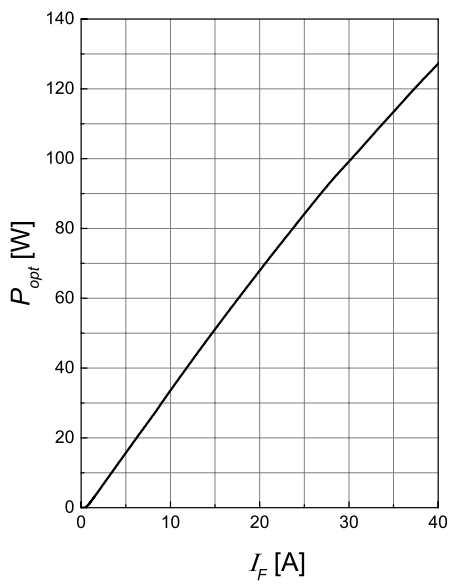

Preliminary datasheet version

Centroid Wavelength ³⁾

$$\lambda_{\text{centroid}} = f(T_J); I_F = 40\text{A}; t_p = 100\text{ns}; D = 0.01\%$$

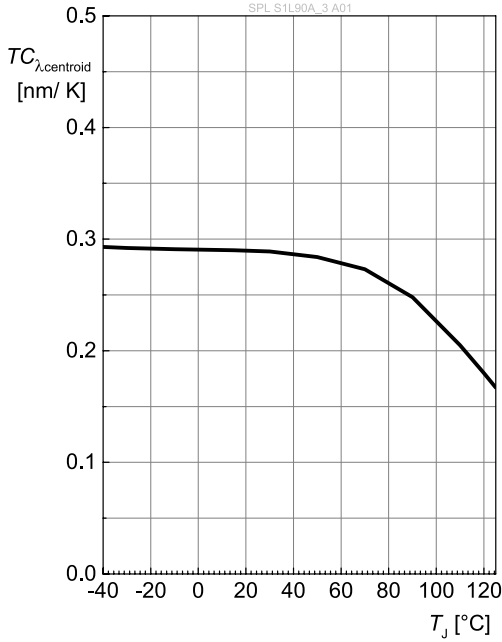

Centroid Wavelength ³⁾

$$\lambda_{\text{centroid}} = f(T_J); I_F = 40\text{A}; t_p = 100\text{ns}; D = 0.01\%$$

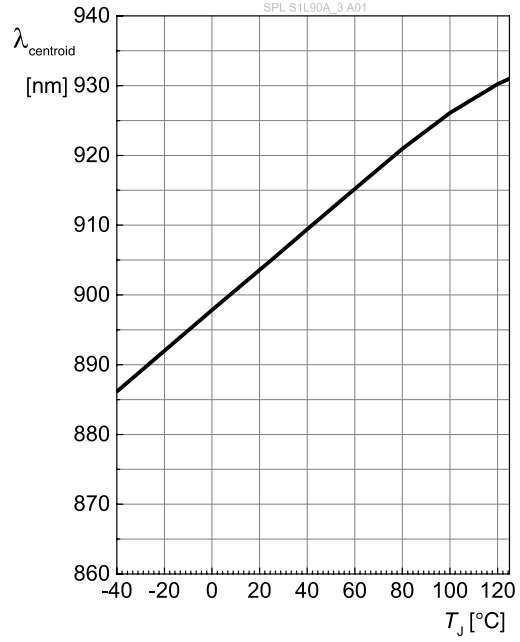

Centroid Wavelength ³⁾

$$\lambda_{\text{centroid}} = f(T_S); I_F = 40\text{A}; t_p = 100\text{ns}; D = 0.01\%$$

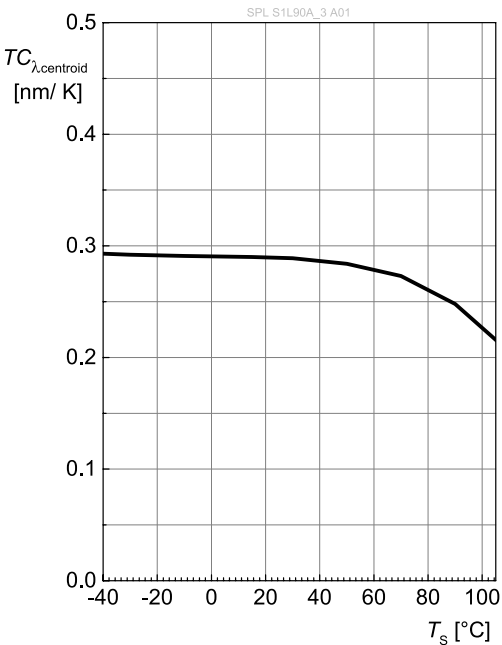

Centroid Wavelength ³⁾

$$\lambda_{\text{centroid}} = f(T_S); I_F = 40\text{A}; t_p = 100\text{ns}; D = 0.01\%$$

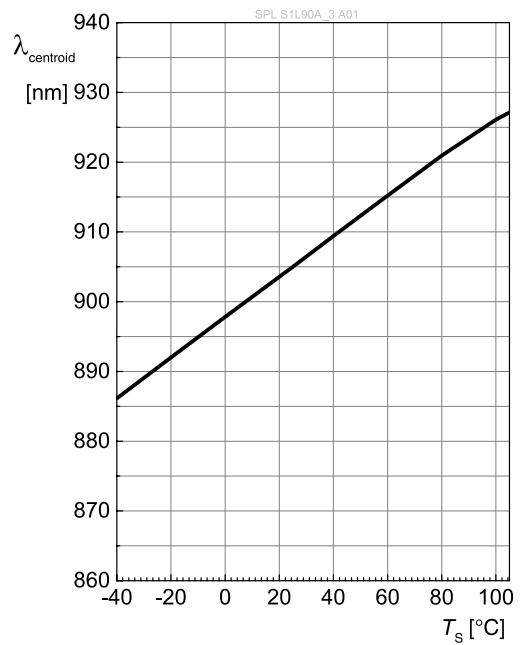

Preliminary datasheet version

Peak Output Power

$$P_{opt} = f(T_J); I_F = 40A; t_p = 100ns; D = 0.01\%$$

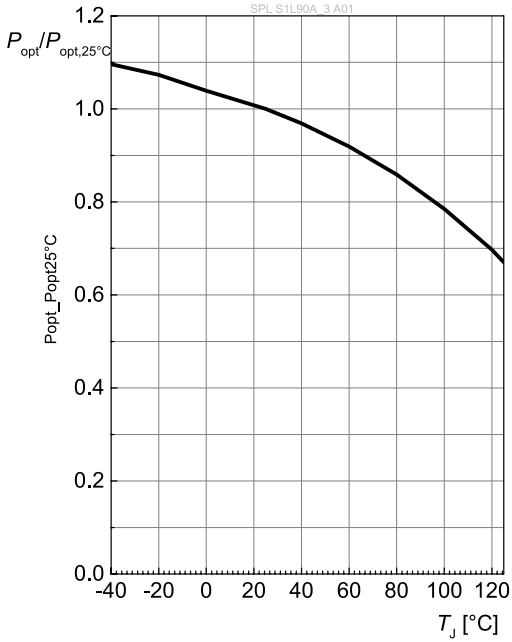

Peak Output Power

$$P_{opt} = f(T_S); I_F = 40A; t_p = 100ns; D = 0.01\%$$

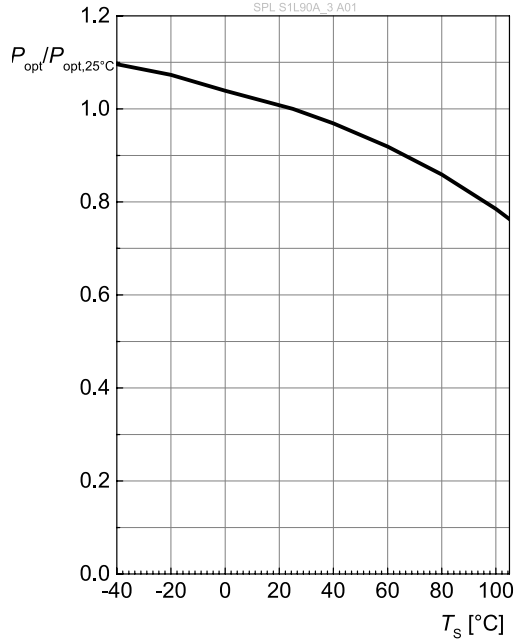

Permissible Pulse Handling Capability

$$I_F = f(t_p); D = \text{parameter}; P_{opt, typ}; R_{thjs, typ}; T_S = 85^\circ\text{C (typ)}$$

Permissible Pulse Handling Capability

$$I_F = f(t_p); D = \text{parameter}; P_{opt, min}; R_{thjs, max}; T_S = 85^\circ\text{C}$$

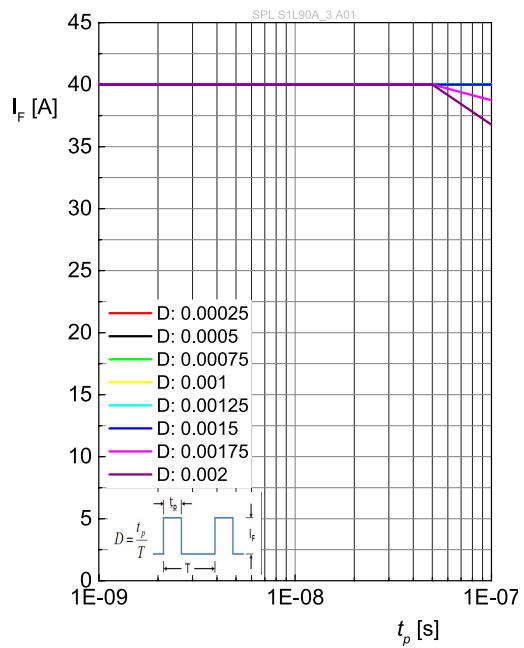
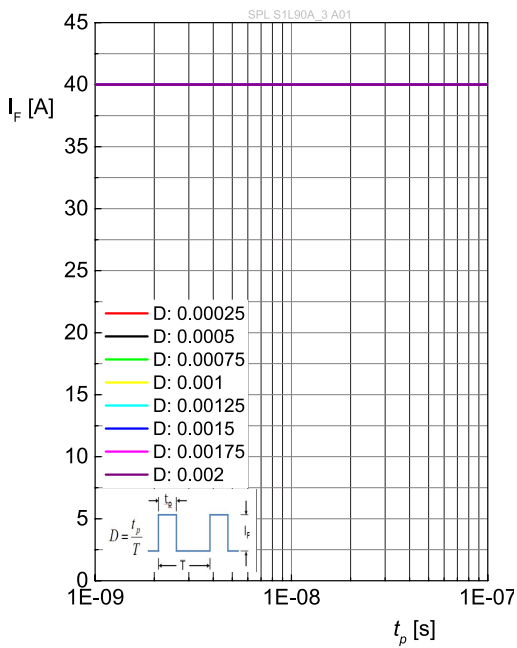

Preliminary datasheet version

Permissible Pulse Handling Capability

$I_F = f(t_p)$; $D = \text{parameter}$; $P_{opt, typ}$; $R_{thjs, typ}$; $T_S = 105^\circ\text{C}$

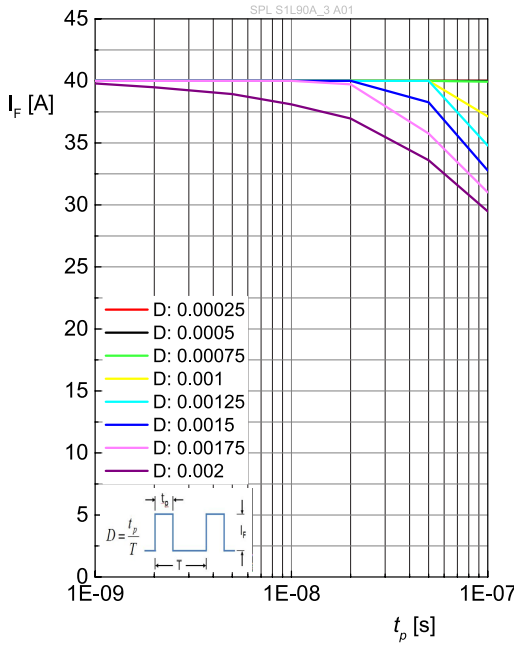

Permissible Pulse Handling Capability

$I_F = f(t_p)$; $D = \text{parameter}$; $P_{opt, min}$; $R_{thjs, max}$; $T_S = 105^\circ\text{C}$

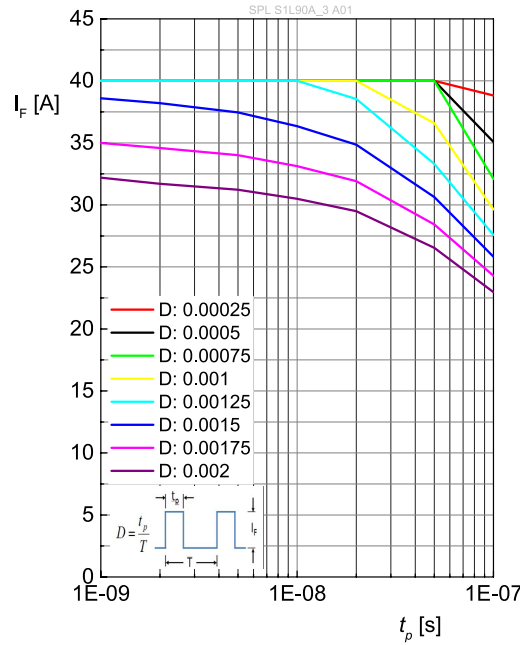

Dimensional Drawing ⁵⁾

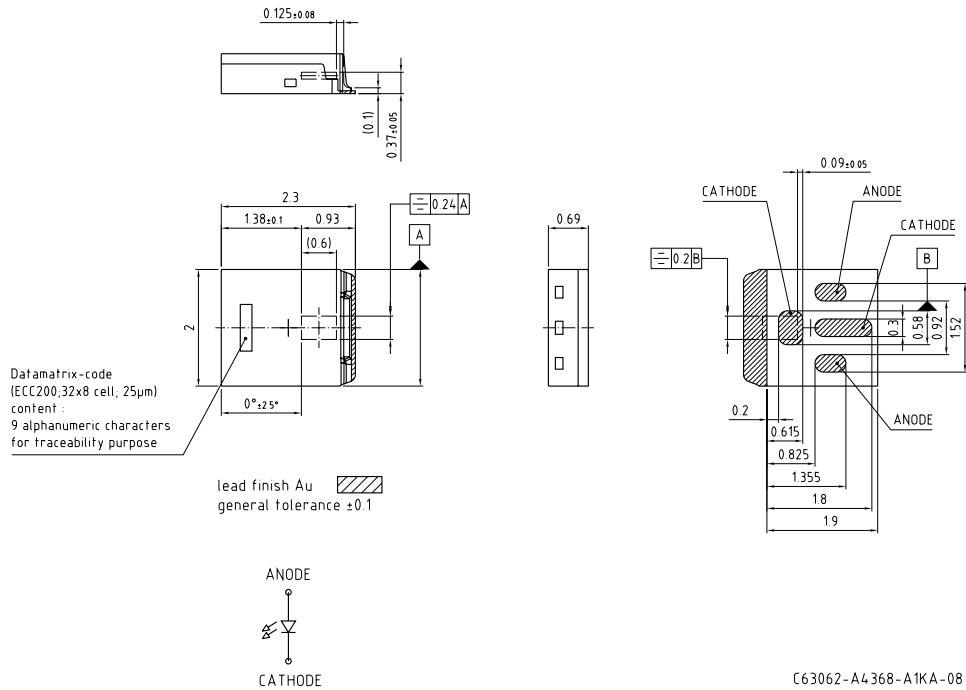

Further Information:

Approximate Weight: 8.0 mg

Recommended Solder Pad ⁵⁾

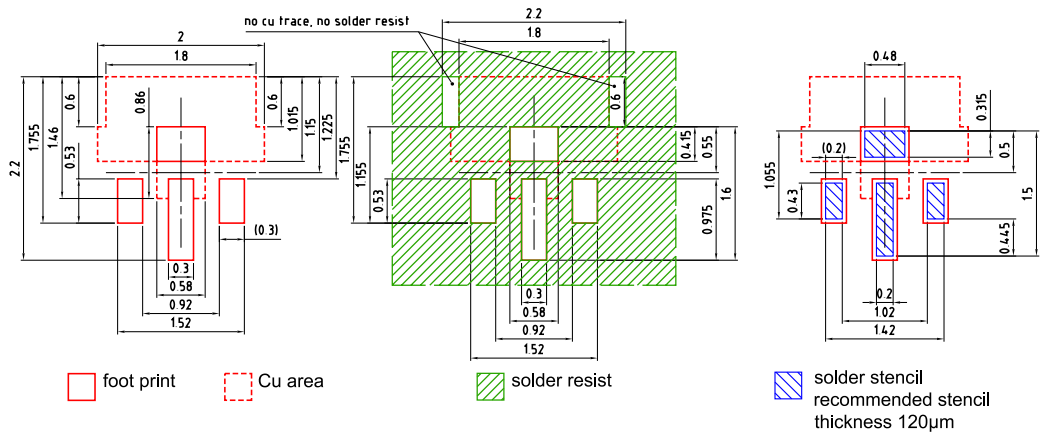

Component Location on Pad

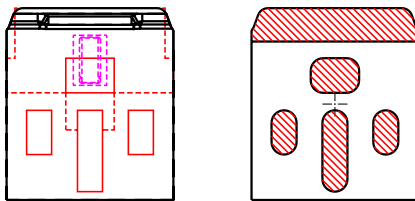

E062.3010.255 -03

Reflow Soldering Profile

Product complies to MSL Level 3 acc. to JEDEC J-STD-020E

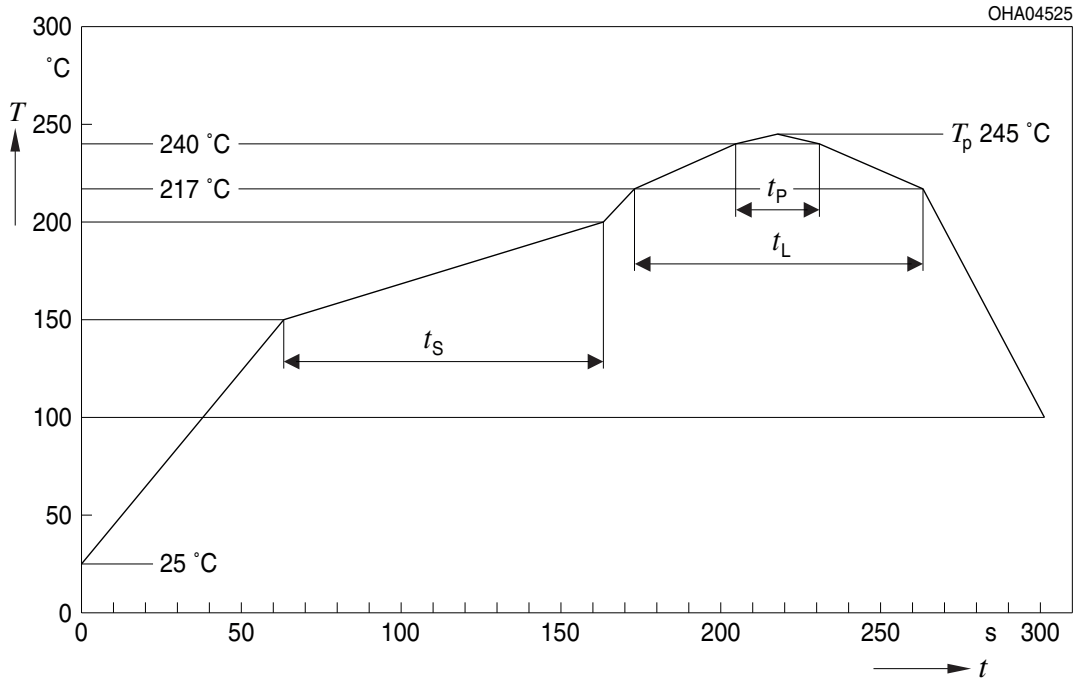

Profile Feature	Symbol	Pb-Free (SnAgCu) Assembly			Unit
		Minimum	Recommendation	Maximum	
Ramp-up rate to preheat ^{*)} 25 °C to 150 °C			2	3	K/s
Time t_s T_{Smin} to T_{Smax}	t_s	60	100	120	s
Ramp-up rate to peak ^{*)} T_{Smax} to T_p			2	3	K/s
Liquidus temperature	T_L		217		°C
Time above liquidus temperature	t_L		80	100	s
Peak temperature	T_p		245	260	°C
Time within 5 °C of the specified peak temperature $T_p - 5$ K	t_p	10	20	30	s
Ramp-down rate* T_p to 100 °C			3	6	K/s
Time 25 °C to T_p				480	s

All temperatures refer to the center of the package, measured on the top of the component
 *) slope calculation DT/Dt : Dt max. 5 s; fulfillment for the whole T-range

Preliminary datasheet version

Taping ⁵⁾

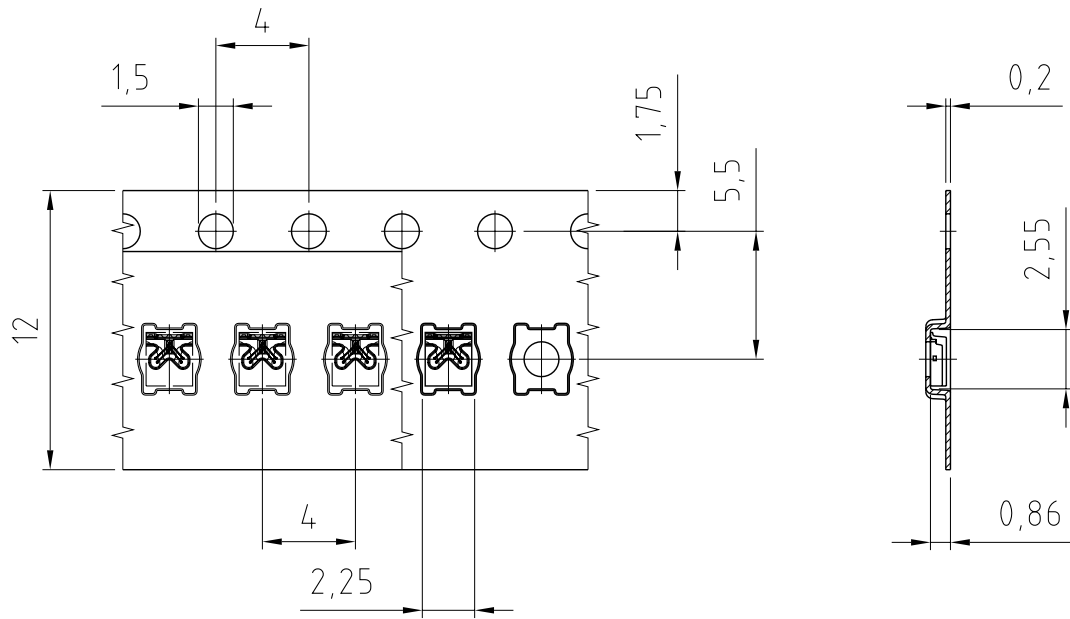

C63062-A4368-B10-03

Tape and Reel ⁶⁾

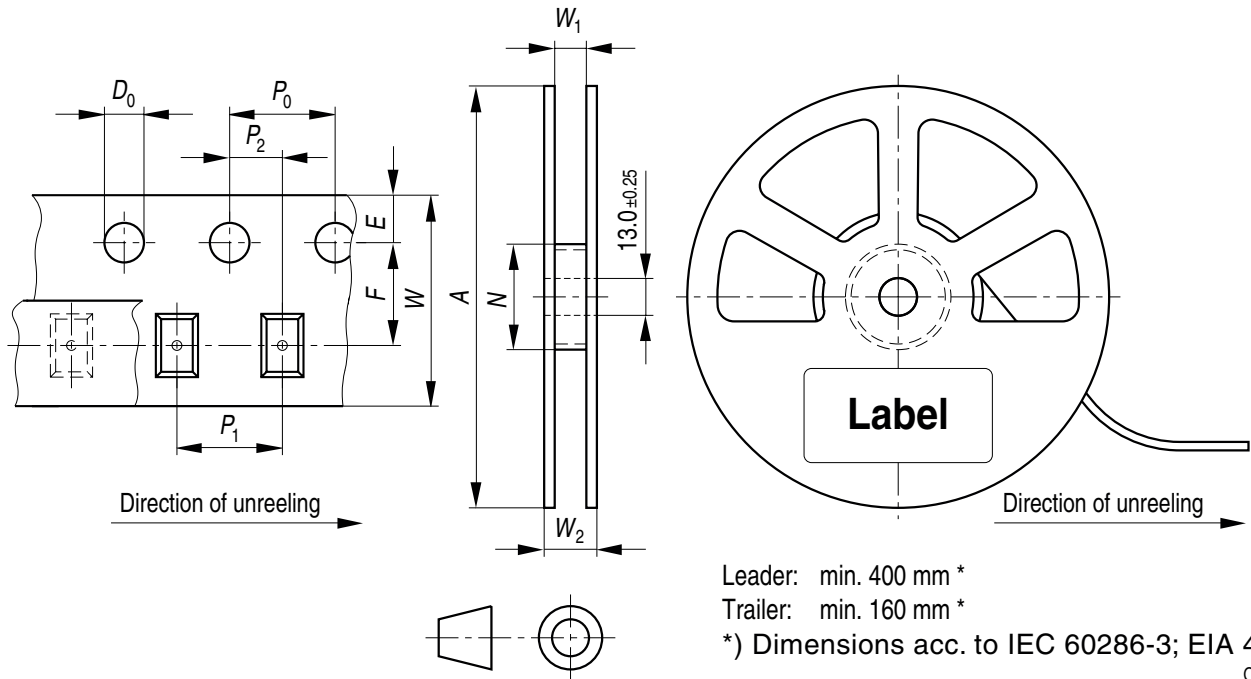

Leader: min. 400 mm *

Trailer: min. 160 mm *

*) Dimensions acc. to IEC 60286-3; EIA 481-D

OHAY0324

Reel Dimensions

A	W	N_{min}	W_1	W_{2max}	Pieces per PU
180 mm	12 + 0.3 / - 0.1 mm	60 mm	12.4 + 2 mm	18.4 mm	500

Barcode-Product-Label (BPL)

OSRAM Opto Semiconductors LX XXXX BIN1: XX-XX-X-XXX-X



RoHS Compliant

(6P) BATCH NO: 1234567890 ML Temp ST
X XXX °C X

(1T) LOT NO: 1234567890 (9D) D/C: 1234

(X) PROD NO: 123456789(Q)QTY: 9999 (G) GROUP: XX-XX-X-X

Pack: RXX
DEMY XXX
X_X123_1234.1234 X

OHA04563

Dry Packing Process and Materials ⁵⁾

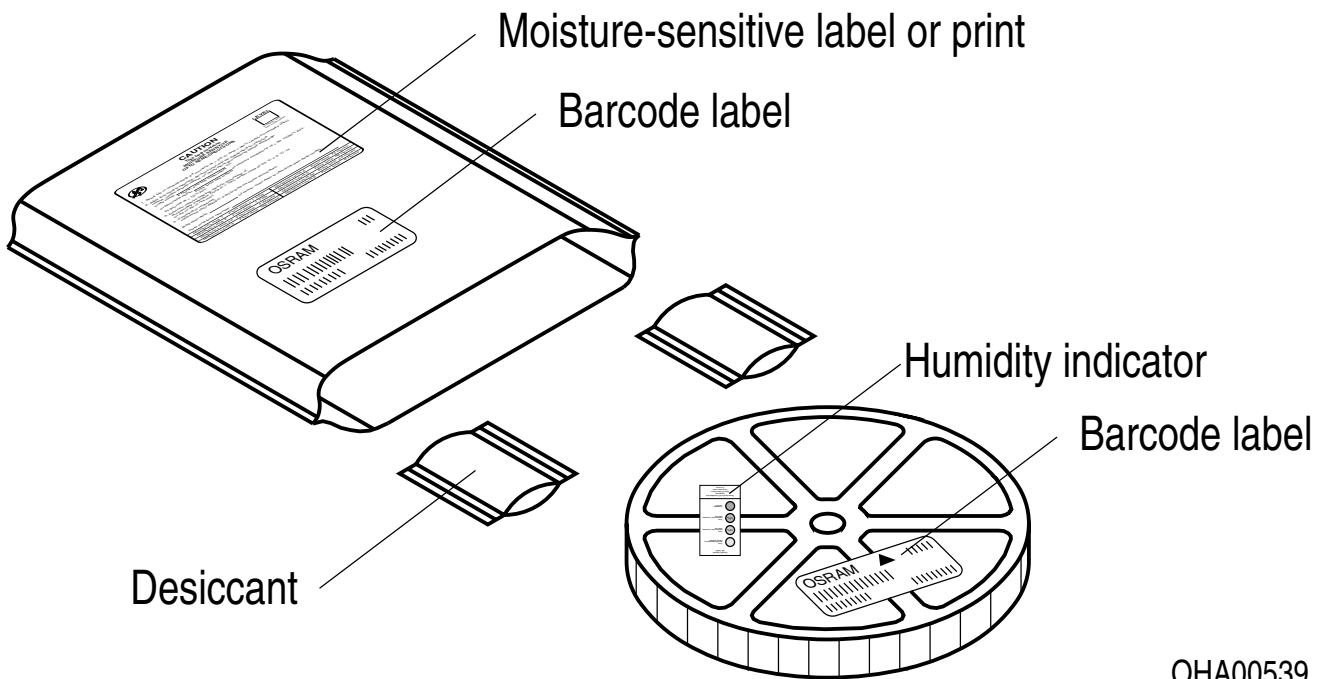

OHA00539

Moisture-sensitive product is packed in a dry bag containing desiccant and a humidity card according JEDEC-STD-033.

Preliminary datasheet version

Schematic Transportation Box ⁵⁾

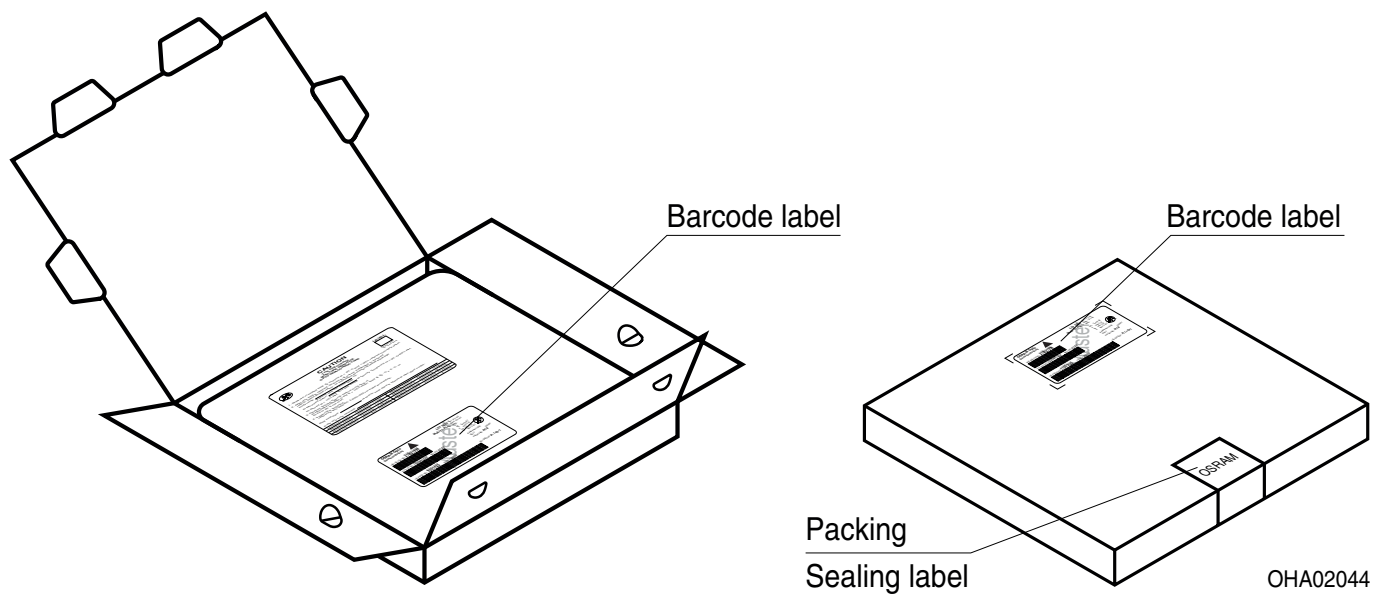

Dimensions of Transportation Box

Width	Length	Height
195 ± 5 mm	195 ± 5 mm	30 ± 5 mm

Notes

Depending on the mode of operation, these devices emit highly concentrated visible and non visible light which can be hazardous to the human eye. Products which incorporate these devices have to follow the safety precautions given in IEC 60825-1.

Subcomponents of this device contain, in addition to other substances, metal filled materials including silver. Metal filled materials can be affected by environments that contain traces of aggressive substances. Therefore, we recommend that customers minimize device exposure to aggressive substances during storage, production, and use. Devices that showed visible discoloration when tested using the described tests above did show no performance deviations within failure limits during the stated test duration. Respective failure limits are described in the IEC60810.

Tape and Reel:

Packing unit can vary 2 % from the stated value.

For further application related information please visit www.osram-os.com/appnotes

Disclaimer

OSRAM OS assumes no liability whatsoever for any use of this document or its content by recipient including, but not limited to, for any design in activities based on this preliminary draft version. OSRAM OS may e.g. decide at its sole discretion to stop developing and/or finalising the underlying design at any time.

Attention please!

The information describes the type of component and shall not be considered as assured characteristics. Terms of delivery and rights to change design reserved. Due to technical requirements components may contain dangerous substances.

For information on the types in question please contact our Sales Organization.

If printed or downloaded, please find the latest version on the OSRAM OS website.

Packing

Please use the recycling operators known to you. We can also help you – get in touch with your nearest sales office. By agreement we will take packing material back, if it is sorted. You must bear the costs of transport. For packing material that is returned to us unsorted or which we are not obliged to accept, we shall have to invoice you for any costs incurred.

Product and functional safety devices/applications or medical devices/applications

OSRAM OS components are not developed, constructed or tested for the application as safety relevant component or for the application in medical devices.

OSRAM OS products are not qualified at module and system level for such application.

In case buyer – or customer supplied by buyer – considers using OSRAM OS components in product safety devices/applications or medical devices/applications, buyer and/or customer has to inform the local sales partner of OSRAM OS immediately and OSRAM OS and buyer and /or customer will analyze and coordinate the customer-specific request between OSRAM OS and buyer and/or customer.

Glossary

- 1) **Reverse Operation:** Reverse Operation of 10 hours is permissible in total. Continuous reverse operation is not allowed.
- 2) **Thermal resistance:** junction - soldering point, of the device only, mounted on an ideal heatsink (e.g. metal block)
- 3) **Typical Values:** Due to the special conditions of the manufacturing processes of semiconductor devices, the typical data or calculated correlations of technical parameters can only reflect statistical figures. These do not necessarily correspond to the actual parameters of each single product, which could differ from the typical data and calculated correlations or the typical characteristic line. If requested, e.g. because of technical improvements, these typ. data will be changed without any further notice.
- 4) **Testing temperature:** TA = 25°C (unless otherwise specified)
- 5) **Tolerance of Measure:** Unless otherwise noted in drawing, tolerances are specified with ± 0.1 and dimensions are specified in mm.
- 6) **Tape and Reel:** All dimensions and tolerances are specified acc. IEC 60286-3 and specified in mm.

Revision History

Version	Date	Change
0.0	2019-07-19	Initial Version
0.0	2019-09-27	Initial Version

Published by OSRAM Opto Semiconductors GmbH EU RoHS and China RoHS compliant product
Leibnizstraße 4, D-93055 Regensburg
www.osram-os.com © All Rights Reserved.



此产品符合欧盟 RoHS 指令的要求；
按照中国的相关法规和标准，不含有毒有害物质或元素。