



# SGM826B/SGM827B/SGM828B

## Small Package, High Precision Voltage Detectors with Internal Delay Time Circuit

---

### GENERAL DESCRIPTION

The SGM826B, SGM827B and SGM828B are low-power and high-accuracy voltage detectors with fixed built-in delay time. The adjustable threshold range is 2.2V to 6V with increments of 0.1V, which greatly provides application flexibility. For the delay of the release signal, there are three options, 50ms, 100ms, and 200ms. The OUT pin is an N-channel open-drain output with active-low reset.

All devices are all available in Green SOT-23-5 and SC70-4 (R) packages. They are specified over the -40°C to +125°C operating junction temperature range.

### FEATURES

- **Operating Voltage Range: 0.95V to 10V**
- **High Accuracy Detection:  $\pm 1.5\%$  at  $T_J = +25^\circ\text{C}$**
- **Low Current Consumption:**  
**1 $\mu\text{A}$  (TYP) at  $V_{CC} = 3.5\text{V}$**
- **Detection Voltage Range: 2.2V to 6.0V (0.1V Increments)**
- **Hysteresis Characteristics: 1.5% (TYP)**
- **Delay Time On/Off Switching Function (DS Pin)**
- **Three Delay Time:**
  - SGM826B: 50ms (TYP)**
  - SGM827B: 100ms (TYP)**
  - SGM828B: 200ms (TYP)**
- **N-Channel Open-Drain Output**
- **Available in Green SOT-23-5 and SC70-4 (R) Packages**

### APPLICATIONS

Power Switching  
Computers  
Portable Equipment  
Power Failure Detection Circuits

**PACKAGE/ORDERING INFORMATION**

MODEL	DETECTION VOLTAGE (V)	PACKAGE DESCRIPTION	SPECIFIED TEMPERATURE RANGE	ORDERING NUMBER	PACKAGE MARKING	PACKING OPTION
SGM826B-2.2	2.2	SOT-23-5	-40°C to +125°C	SGM826B-2.2XN5G/TR	SHHXX	Tape and Reel, 3000
		SC70-4 (R)	-40°C to +125°C	SGM826B-2.2XC4G/TR	SHIXX	Tape and Reel, 3000
SGM826B-2.3	2.3	SOT-23-5	-40°C to +125°C	SGM826B-2.3XN5G/TR	SHJXX	Tape and Reel, 3000
		SC70-4 (R)	-40°C to +125°C	SGM826B-2.3XC4G/TR	SHKXX	Tape and Reel, 3000
SGM826B-2.4	2.4	SOT-23-5	-40°C to +125°C	SGM826B-2.4XN5G/TR	SHLXX	Tape and Reel, 3000
		SC70-4 (R)	-40°C to +125°C	SGM826B-2.4XC4G/TR	SHMXX	Tape and Reel, 3000
SGM826B-2.5	2.5	SOT-23-5	-40°C to +125°C	SGM826B-2.5XN5G/TR	SHNXX	Tape and Reel, 3000
		SC70-4 (R)	-40°C to +125°C	SGM826B-2.5XC4G/TR	SHPXX	Tape and Reel, 3000
SGM826B-2.6	2.6	SOT-23-5	-40°C to +125°C	SGM826B-2.6XN5G/TR	R5EXX	Tape and Reel, 3000
		SC70-4 (R)	-40°C to +125°C	SGM826B-2.6XC4G/TR	SHQXX	Tape and Reel, 3000
SGM826B-2.7	2.7	SOT-23-5	-40°C to +125°C	SGM826B-2.7XN5G/TR	SHRXX	Tape and Reel, 3000
		SC70-4 (R)	-40°C to +125°C	SGM826B-2.7XC4G/TR	SHSXX	Tape and Reel, 3000
SGM826B-2.8	2.8	SOT-23-5	-40°C to +125°C	SGM826B-2.8XN5G/TR	SHTXX	Tape and Reel, 3000
		SC70-4 (R)	-40°C to +125°C	SGM826B-2.8XC4G/TR	SHUXX	Tape and Reel, 3000
SGM826B-2.9	2.9	SOT-23-5	-40°C to +125°C	SGM826B-2.9XN5G/TR	SHVXX	Tape and Reel, 3000
		SC70-4 (R)	-40°C to +125°C	SGM826B-2.9XC4G/TR	SHWXX	Tape and Reel, 3000
SGM826B-3.0	3.0	SOT-23-5	-40°C to +125°C	SGM826B-3.0XN5G/TR	SHXXX	Tape and Reel, 3000
		SC70-4 (R)	-40°C to +125°C	SGM826B-3.0XC4G/TR	SHYXX	Tape and Reel, 3000
SGM826B-3.1	3.1	SOT-23-5	-40°C to +125°C	SGM826B-3.1XN5G/TR	SHZXX	Tape and Reel, 3000
		SC70-4 (R)	-40°C to +125°C	SGM826B-3.1XC4G/TR	SIGXX	Tape and Reel, 3000
SGM826B-3.2	3.2	SOT-23-5	-40°C to +125°C	SGM826B-3.2XN5G/TR	SIHXX	Tape and Reel, 3000
		SC70-4 (R)	-40°C to +125°C	SGM826B-3.2XC4G/TR	SIIXX	Tape and Reel, 3000
SGM826B-3.3	3.3	SOT-23-5	-40°C to +125°C	SGM826B-3.3XN5G/TR	SIJXX	Tape and Reel, 3000
		SC70-4 (R)	-40°C to +125°C	SGM826B-3.3XC4G/TR	SIKXX	Tape and Reel, 3000
SGM826B-3.4	3.4	SOT-23-5	-40°C to +125°C	SGM826B-3.4XN5G/TR	SILXX	Tape and Reel, 3000
		SC70-4 (R)	-40°C to +125°C	SGM826B-3.4XC4G/TR	SIMXX	Tape and Reel, 3000
SGM826B-3.5	3.5	SOT-23-5	-40°C to +125°C	SGM826B-3.5XN5G/TR	SINXX	Tape and Reel, 3000
		SC70-4 (R)	-40°C to +125°C	SGM826B-3.5XC4G/TR	SIPXX	Tape and Reel, 3000
SGM826B-3.6	3.6	SOT-23-5	-40°C to +125°C	SGM826B-3.6XN5G/TR	SIQXX	Tape and Reel, 3000
		SC70-4 (R)	-40°C to +125°C	SGM826B-3.6XC4G/TR	SIRXX	Tape and Reel, 3000

**PACKAGE/ORDERING INFORMATION (continued)**

MODEL	DETECTION VOLTAGE (V)	PACKAGE DESCRIPTION	SPECIFIED TEMPERATURE RANGE	ORDERING NUMBER	PACKAGE MARKING	PACKING OPTION
SGM826B-3.7	3.7	SOT-23-5	-40°C to +125°C	SGM826B-3.7XN5G/TR	SISXX	Tape and Reel, 3000
		SC70-4 (R)	-40°C to +125°C	SGM826B-3.7XC4G/TR	SITXX	Tape and Reel, 3000
SGM826B-3.8	3.8	SOT-23-5	-40°C to +125°C	SGM826B-3.8XN5G/TR	SIUXX	Tape and Reel, 3000
		SC70-4 (R)	-40°C to +125°C	SGM826B-3.8XC4G/TR	SIVXX	Tape and Reel, 3000
SGM826B-3.9	3.9	SOT-23-5	-40°C to +125°C	SGM826B-3.9XN5G/TR	SIWXX	Tape and Reel, 3000
		SC70-4 (R)	-40°C to +125°C	SGM826B-3.9XC4G/TR	SIXXX	Tape and Reel, 3000
SGM826B-4.0	4.0	SOT-23-5	-40°C to +125°C	SGM826B-4.0XN5G/TR	SIYXX	Tape and Reel, 3000
		SC70-4 (R)	-40°C to +125°C	SGM826B-4.0XC4G/TR	SIZXX	Tape and Reel, 3000
SGM826B-4.1	4.1	SOT-23-5	-40°C to +125°C	SGM826B-4.1XN5G/TR	SJGXX	Tape and Reel, 3000
		SC70-4 (R)	-40°C to +125°C	SGM826B-4.1XC4G/TR	SJHXX	Tape and Reel, 3000
SGM826B-4.2	4.2	SOT-23-5	-40°C to +125°C	SGM826B-4.2XN5G/TR	SJIXX	Tape and Reel, 3000
		SC70-4 (R)	-40°C to +125°C	SGM826B-4.2XC4G/TR	SJJXX	Tape and Reel, 3000
SGM826B-4.3	4.3	SOT-23-5	-40°C to +125°C	SGM826B-4.3XN5G/TR	SJKXX	Tape and Reel, 3000
		SC70-4 (R)	-40°C to +125°C	SGM826B-4.3XC4G/TR	SJLXX	Tape and Reel, 3000
SGM826B-4.4	4.4	SOT-23-5	-40°C to +125°C	SGM826B-4.4XN5G/TR	SJMXX	Tape and Reel, 3000
		SC70-4 (R)	-40°C to +125°C	SGM826B-4.4XC4G/TR	SJNXX	Tape and Reel, 3000
SGM826B-4.5	4.5	SOT-23-5	-40°C to +125°C	SGM826B-4.5XN5G/TR	SJPXX	Tape and Reel, 3000
		SC70-4 (R)	-40°C to +125°C	SGM826B-4.5XC4G/TR	SJQXX	Tape and Reel, 3000
SGM826B-4.6	4.6	SOT-23-5	-40°C to +125°C	SGM826B-4.6XN5G/TR	SJRXX	Tape and Reel, 3000
		SC70-4 (R)	-40°C to +125°C	SGM826B-4.6XC4G/TR	SJSXX	Tape and Reel, 3000
SGM826B-4.7	4.7	SOT-23-5	-40°C to +125°C	SGM826B-4.7XN5G/TR	SJTXX	Tape and Reel, 3000
		SC70-4 (R)	-40°C to +125°C	SGM826B-4.7XC4G/TR	SJUXX	Tape and Reel, 3000
SGM826B-4.8	4.8	SOT-23-5	-40°C to +125°C	SGM826B-4.8XN5G/TR	SJVXX	Tape and Reel, 3000
		SC70-4 (R)	-40°C to +125°C	SGM826B-4.8XC4G/TR	SJWXX	Tape and Reel, 3000
SGM826B-4.9	4.9	SOT-23-5	-40°C to +125°C	SGM826B-4.9XN5G/TR	SJXXX	Tape and Reel, 3000
		SC70-4 (R)	-40°C to +125°C	SGM826B-4.9XC4G/TR	SJYXX	Tape and Reel, 3000
SGM826B-5.0	5.0	SOT-23-5	-40°C to +125°C	SGM826B-5.0XN5G/TR	SJZXX	Tape and Reel, 3000
		SC70-4 (R)	-40°C to +125°C	SGM826B-5.0XC4G/TR	SKGXX	Tape and Reel, 3000
SGM826B-5.1	5.1	SOT-23-5	-40°C to +125°C	SGM826B-5.1XN5G/TR	SKHXX	Tape and Reel, 3000
		SC70-4 (R)	-40°C to +125°C	SGM826B-5.1XC4G/TR	SKIXX	Tape and Reel, 3000

**PACKAGE/ORDERING INFORMATION (continued)**

MODEL	DETECTION VOLTAGE (V)	PACKAGE DESCRIPTION	SPECIFIED TEMPERATURE RANGE	ORDERING NUMBER	PACKAGE MARKING	PACKING OPTION
SGM826B-5.2	5.2	SOT-23-5	-40°C to +125°C	SGM826B-5.2XN5G/TR	SKJXX	Tape and Reel, 3000
		SC70-4 (R)	-40°C to +125°C	SGM826B-5.2XC4G/TR	SKKXX	Tape and Reel, 3000
SGM826B-5.3	5.3	SOT-23-5	-40°C to +125°C	SGM826B-5.3XN5G/TR	SKLXX	Tape and Reel, 3000
		SC70-4 (R)	-40°C to +125°C	SGM826B-5.3XC4G/TR	SKMXX	Tape and Reel, 3000
SGM826B-5.4	5.4	SOT-23-5	-40°C to +125°C	SGM826B-5.4XN5G/TR	SKNXX	Tape and Reel, 3000
		SC70-4 (R)	-40°C to +125°C	SGM826B-5.4XC4G/TR	SKPXX	Tape and Reel, 3000
SGM826B-5.5	5.5	SOT-23-5	-40°C to +125°C	SGM826B-5.5XN5G/TR	SKQXX	Tape and Reel, 3000
		SC70-4 (R)	-40°C to +125°C	SGM826B-5.5XC4G/TR	SKRXX	Tape and Reel, 3000
SGM826B-5.6	5.6	SOT-23-5	-40°C to +125°C	SGM826B-5.6XN5G/TR	SKSXX	Tape and Reel, 3000
		SC70-4 (R)	-40°C to +125°C	SGM826B-5.6XC4G/TR	SKTXX	Tape and Reel, 3000
SGM826B-5.7	5.7	SOT-23-5	-40°C to +125°C	SGM826B-5.7XN5G/TR	SKUXX	Tape and Reel, 3000
		SC70-4 (R)	-40°C to +125°C	SGM826B-5.7XC4G/TR	SKVXX	Tape and Reel, 3000
SGM826B-5.8	5.8	SOT-23-5	-40°C to +125°C	SGM826B-5.8XN5G/TR	SKWXX	Tape and Reel, 3000
		SC70-4 (R)	-40°C to +125°C	SGM826B-5.8XC4G/TR	SKXXX	Tape and Reel, 3000
SGM826B-5.9	5.9	SOT-23-5	-40°C to +125°C	SGM826B-5.9XN5G/TR	SKYXX	Tape and Reel, 3000
		SC70-4 (R)	-40°C to +125°C	SGM826B-5.9XC4G/TR	SKZXX	Tape and Reel, 3000
SGM826B-6.0	6.0	SOT-23-5	-40°C to +125°C	SGM826B-6.0XN5G/TR	SLGXX	Tape and Reel, 3000
		SC70-4 (R)	-40°C to +125°C	SGM826B-6.0XC4G/TR	SLHXX	Tape and Reel, 3000
SGM827B-2.2	2.2	SOT-23-5	-40°C to +125°C	SGM827B-2.2XN5G/TR	SLIXX	Tape and Reel, 3000
		SC70-4 (R)	-40°C to +125°C	SGM827B-2.2XC4G/TR	SLJXX	Tape and Reel, 3000
SGM827B-2.3	2.3	SOT-23-5	-40°C to +125°C	SGM827B-2.3XN5G/TR	SLKXX	Tape and Reel, 3000
		SC70-4 (R)	-40°C to +125°C	SGM827B-2.3XC4G/TR	SLLXX	Tape and Reel, 3000
SGM827B-2.4	2.4	SOT-23-5	-40°C to +125°C	SGM827B-2.4XN5G/TR	SLMXX	Tape and Reel, 3000
		SC70-4 (R)	-40°C to +125°C	SGM827B-2.4XC4G/TR	SLNXX	Tape and Reel, 3000
SGM827B-2.5	2.5	SOT-23-5	-40°C to +125°C	SGM827B-2.5XN5G/TR	SLPXX	Tape and Reel, 3000
		SC70-4 (R)	-40°C to +125°C	SGM827B-2.5XC4G/TR	SLQXX	Tape and Reel, 3000
SGM827B-2.6	2.6	SOT-23-5	-40°C to +125°C	SGM827B-2.6XN5G/TR	SLRXX	Tape and Reel, 3000
		SC70-4 (R)	-40°C to +125°C	SGM827B-2.6XC4G/TR	SLSXX	Tape and Reel, 3000
SGM827B-2.7	2.7	SOT-23-5	-40°C to +125°C	SGM827B-2.7XN5G/TR	SLTXX	Tape and Reel, 3000
		SC70-4 (R)	-40°C to +125°C	SGM827B-2.7XC4G/TR	SLUXX	Tape and Reel, 3000

**PACKAGE/ORDERING INFORMATION (continued)**

MODEL	DETECTION VOLTAGE (V)	PACKAGE DESCRIPTION	SPECIFIED TEMPERATURE RANGE	ORDERING NUMBER	PACKAGE MARKING	PACKING OPTION
SGM827B-2.8	2.8	SOT-23-5	-40°C to +125°C	SGM827B-2.8XN5G/TR	SLVXX	Tape and Reel, 3000
		SC70-4 (R)	-40°C to +125°C	SGM827B-2.8XC4G/TR	SLWXX	Tape and Reel, 3000
SGM827B-2.9	2.9	SOT-23-5	-40°C to +125°C	SGM827B-2.9XN5G/TR	SLXXX	Tape and Reel, 3000
		SC70-4 (R)	-40°C to +125°C	SGM827B-2.9XC4G/TR	SLYXX	Tape and Reel, 3000
SGM827B-3.0	3.0	SOT-23-5	-40°C to +125°C	SGM827B-3.0XN5G/TR	SLZXX	Tape and Reel, 3000
		SC70-4 (R)	-40°C to +125°C	SGM827B-3.0XC4G/TR	SMGXX	Tape and Reel, 3000
SGM827B-3.1	3.1	SOT-23-5	-40°C to +125°C	SGM827B-3.1XN5G/TR	SMHXX	Tape and Reel, 3000
		SC70-4 (R)	-40°C to +125°C	SGM827B-3.1XC4G/TR	SMIXX	Tape and Reel, 3000
SGM827B-3.2	3.2	SOT-23-5	-40°C to +125°C	SGM827B-3.2XN5G/TR	SMJXX	Tape and Reel, 3000
		SC70-4 (R)	-40°C to +125°C	SGM827B-3.2XC4G/TR	SMKXX	Tape and Reel, 3000
SGM827B-3.3	3.3	SOT-23-5	-40°C to +125°C	SGM827B-3.3XN5G/TR	SMLXX	Tape and Reel, 3000
		SC70-4 (R)	-40°C to +125°C	SGM827B-3.3XC4G/TR	SMNXX	Tape and Reel, 3000
SGM827B-3.4	3.4	SOT-23-5	-40°C to +125°C	SGM827B-3.4XN5G/TR	SMPXX	Tape and Reel, 3000
		SC70-4 (R)	-40°C to +125°C	SGM827B-3.4XC4G/TR	SMQXX	Tape and Reel, 3000
SGM827B-3.5	3.5	SOT-23-5	-40°C to +125°C	SGM827B-3.5XN5G/TR	SMRXX	Tape and Reel, 3000
		SC70-4 (R)	-40°C to +125°C	SGM827B-3.5XC4G/TR	SMSXX	Tape and Reel, 3000
SGM827B-3.6	3.6	SOT-23-5	-40°C to +125°C	SGM827B-3.6XN5G/TR	SMTXX	Tape and Reel, 3000
		SC70-4 (R)	-40°C to +125°C	SGM827B-3.6XC4G/TR	SMUXX	Tape and Reel, 3000
SGM827B-3.7	3.7	SOT-23-5	-40°C to +125°C	SGM827B-3.7XN5G/TR	SMVXX	Tape and Reel, 3000
		SC70-4 (R)	-40°C to +125°C	SGM827B-3.7XC4G/TR	SMXXX	Tape and Reel, 3000
SGM827B-3.8	3.8	SOT-23-5	-40°C to +125°C	SGM827B-3.8XN5G/TR	SMYXX	Tape and Reel, 3000
		SC70-4 (R)	-40°C to +125°C	SGM827B-3.8XC4G/TR	SMZXX	Tape and Reel, 3000
SGM827B-3.9	3.9	SOT-23-5	-40°C to +125°C	SGM827B-3.9XN5G/TR	SNGXX	Tape and Reel, 3000
		SC70-4 (R)	-40°C to +125°C	SGM827B-3.9XC4G/TR	SNHXX	Tape and Reel, 3000
SGM827B-4.0	4.0	SOT-23-5	-40°C to +125°C	SGM827B-4.0XN5G/TR	SNIXX	Tape and Reel, 3000
		SC70-4 (R)	-40°C to +125°C	SGM827B-4.0XC4G/TR	SNJXX	Tape and Reel, 3000
SGM827B-4.1	4.1	SOT-23-5	-40°C to +125°C	SGM827B-4.1XN5G/TR	SNKXX	Tape and Reel, 3000
		SC70-4 (R)	-40°C to +125°C	SGM827B-4.1XC4G/TR	SNLXX	Tape and Reel, 3000
SGM827B-4.2	4.2	SOT-23-5	-40°C to +125°C	SGM827B-4.2XN5G/TR	SNMXX	Tape and Reel, 3000
		SC70-4 (R)	-40°C to +125°C	SGM827B-4.2XC4G/TR	SNNXX	Tape and Reel, 3000

**PACKAGE/ORDERING INFORMATION (continued)**

MODEL	DETECTION VOLTAGE (V)	PACKAGE DESCRIPTION	SPECIFIED TEMPERATURE RANGE	ORDERING NUMBER	PACKAGE MARKING	PACKING OPTION
SGM827B-4.3	4.3	SOT-23-5	-40°C to +125°C	SGM827B-4.3XN5G/TR	SNPXX	Tape and Reel, 3000
		SC70-4 (R)	-40°C to +125°C	SGM827B-4.3XC4G/TR	SNQXX	Tape and Reel, 3000
SGM827B-4.4	4.4	SOT-23-5	-40°C to +125°C	SGM827B-4.4XN5G/TR	SNRXX	Tape and Reel, 3000
		SC70-4 (R)	-40°C to +125°C	SGM827B-4.4XC4G/TR	SNSXX	Tape and Reel, 3000
SGM827B-4.5	4.5	SOT-23-5	-40°C to +125°C	SGM827B-4.5XN5G/TR	SNTXX	Tape and Reel, 3000
		SC70-4 (R)	-40°C to +125°C	SGM827B-4.5XC4G/TR	SNUXX	Tape and Reel, 3000
SGM827B-4.6	4.6	SOT-23-5	-40°C to +125°C	SGM827B-4.6XN5G/TR	SNVXX	Tape and Reel, 3000
		SC70-4 (R)	-40°C to +125°C	SGM827B-4.6XC4G/TR	SNWXX	Tape and Reel, 3000
SGM827B-4.7	4.7	SOT-23-5	-40°C to +125°C	SGM827B-4.7XN5G/TR	SNXXX	Tape and Reel, 3000
		SC70-4 (R)	-40°C to +125°C	SGM827B-4.7XC4G/TR	SNYXX	Tape and Reel, 3000
SGM827B-4.8	4.8	SOT-23-5	-40°C to +125°C	SGM827B-4.8XN5G/TR	SNZXX	Tape and Reel, 3000
		SC70-4 (R)	-40°C to +125°C	SGM827B-4.8XC4G/TR	SPGXX	Tape and Reel, 3000
SGM827B-4.9	4.9	SOT-23-5	-40°C to +125°C	SGM827B-4.9XN5G/TR	SPHXX	Tape and Reel, 3000
		SC70-4 (R)	-40°C to +125°C	SGM827B-4.9XC4G/TR	SPIXX	Tape and Reel, 3000
SGM827B-5.0	5.0	SOT-23-5	-40°C to +125°C	SGM827B-5.0XN5G/TR	SPJXX	Tape and Reel, 3000
		SC70-4 (R)	-40°C to +125°C	SGM827B-5.0XC4G/TR	OOEXX	Tape and Reel, 3000
SGM827B-5.1	5.1	SOT-23-5	-40°C to +125°C	SGM827B-5.1XN5G/TR	SPKXX	Tape and Reel, 3000
		SC70-4 (R)	-40°C to +125°C	SGM827B-5.1XC4G/TR	SPLXX	Tape and Reel, 3000
SGM827B-5.2	5.2	SOT-23-5	-40°C to +125°C	SGM827B-5.2XN5G/TR	SPMXX	Tape and Reel, 3000
		SC70-4 (R)	-40°C to +125°C	SGM827B-5.2XC4G/TR	SPNXX	Tape and Reel, 3000
SGM827B-5.3	5.3	SOT-23-5	-40°C to +125°C	SGM827B-5.3XN5G/TR	SPPXX	Tape and Reel, 3000
		SC70-4 (R)	-40°C to +125°C	SGM827B-5.3XC4G/TR	SPQXX	Tape and Reel, 3000
SGM827B-5.4	5.4	SOT-23-5	-40°C to +125°C	SGM827B-5.4XN5G/TR	SPRXX	Tape and Reel, 3000
		SC70-4 (R)	-40°C to +125°C	SGM827B-5.4XC4G/TR	SPSXX	Tape and Reel, 3000
SGM827B-5.5	5.5	SOT-23-5	-40°C to +125°C	SGM827B-5.5XN5G/TR	SPTXX	Tape and Reel, 3000
		SC70-4 (R)	-40°C to +125°C	SGM827B-5.5XC4G/TR	SPUXX	Tape and Reel, 3000
SGM827B-5.6	5.6	SOT-23-5	-40°C to +125°C	SGM827B-5.6XN5G/TR	SPVXX	Tape and Reel, 3000
		SC70-4 (R)	-40°C to +125°C	SGM827B-5.6XC4G/TR	SPWXX	Tape and Reel, 3000
SGM827B-5.7	5.7	SOT-23-5	-40°C to +125°C	SGM827B-5.7XN5G/TR	SPXXX	Tape and Reel, 3000
		SC70-4 (R)	-40°C to +125°C	SGM827B-5.7XC4G/TR	SPYXX	Tape and Reel, 3000

**PACKAGE/ORDERING INFORMATION (continued)**

MODEL	DETECTION VOLTAGE (V)	PACKAGE DESCRIPTION	SPECIFIED TEMPERATURE RANGE	ORDERING NUMBER	PACKAGE MARKING	PACKING OPTION
SGM827B-5.8	5.8	SOT-23-5	-40°C to +125°C	SGM827B-5.8XN5G/TR	SPZXX	Tape and Reel, 3000
		SC70-4 (R)	-40°C to +125°C	SGM827B-5.8XC4G/TR	SQGXX	Tape and Reel, 3000
SGM827B-5.9	5.9	SOT-23-5	-40°C to +125°C	SGM827B-5.9XN5G/TR	SQHXX	Tape and Reel, 3000
		SC70-4 (R)	-40°C to +125°C	SGM827B-5.9XC4G/TR	SQIXX	Tape and Reel, 3000
SGM827B-6.0	6.0	SOT-23-5	-40°C to +125°C	SGM827B-6.0XN5G/TR	SQJXX	Tape and Reel, 3000
		SC70-4 (R)	-40°C to +125°C	SGM827B-6.0XC4G/TR	SQKXX	Tape and Reel, 3000
SGM828B-2.2	2.2	SOT-23-5	-40°C to +125°C	SGM828B-2.2XN5G/TR	SQLXX	Tape and Reel, 3000
		SC70-4 (R)	-40°C to +125°C	SGM828B-2.2XC4G/TR	SQMXX	Tape and Reel, 3000
SGM828B-2.3	2.3	SOT-23-5	-40°C to +125°C	SGM828B-2.3XN5G/TR	SQNXX	Tape and Reel, 3000
		SC70-4 (R)	-40°C to +125°C	SGM828B-2.3XC4G/TR	SQPXX	Tape and Reel, 3000
SGM828B-2.4	2.4	SOT-23-5	-40°C to +125°C	SGM828B-2.4XN5G/TR	SQQXX	Tape and Reel, 3000
		SC70-4 (R)	-40°C to +125°C	SGM828B-2.4XC4G/TR	SQRXX	Tape and Reel, 3000
SGM828B-2.5	2.5	SOT-23-5	-40°C to +125°C	SGM828B-2.5XN5G/TR	SQSXX	Tape and Reel, 3000
		SC70-4 (R)	-40°C to +125°C	SGM828B-2.5XC4G/TR	SQTXX	Tape and Reel, 3000
SGM828B-2.6	2.6	SOT-23-5	-40°C to +125°C	SGM828B-2.6XN5G/TR	SQUXX	Tape and Reel, 3000
		SC70-4 (R)	-40°C to +125°C	SGM828B-2.6XC4G/TR	SQVXX	Tape and Reel, 3000
SGM828B-2.7	2.7	SOT-23-5	-40°C to +125°C	SGM828B-2.7XN5G/TR	SQWXX	Tape and Reel, 3000
		SC70-4 (R)	-40°C to +125°C	SGM828B-2.7XC4G/TR	SQXXX	Tape and Reel, 3000
SGM828B-2.8	2.8	SOT-23-5	-40°C to +125°C	SGM828B-2.8XN5G/TR	SQYXX	Tape and Reel, 3000
		SC70-4 (R)	-40°C to +125°C	SGM828B-2.8XC4G/TR	SQZXX	Tape and Reel, 3000
SGM828B-2.9	2.9	SOT-23-5	-40°C to +125°C	SGM828B-2.9XN5G/TR	SRGXX	Tape and Reel, 3000
		SC70-4 (R)	-40°C to +125°C	SGM828B-2.9XC4G/TR	SRHXX	Tape and Reel, 3000
SGM828B-3.0	3.0	SOT-23-5	-40°C to +125°C	SGM828B-3.0XN5G/TR	SRIXX	Tape and Reel, 3000
		SC70-4 (R)	-40°C to +125°C	SGM828B-3.0XC4G/TR	SRJXX	Tape and Reel, 3000
SGM828B-3.1	3.1	SOT-23-5	-40°C to +125°C	SGM828B-3.1XN5G/TR	SRKXX	Tape and Reel, 3000
		SC70-4 (R)	-40°C to +125°C	SGM828B-3.1XC4G/TR	SRLXX	Tape and Reel, 3000
SGM828B-3.2	3.2	SOT-23-5	-40°C to +125°C	SGM828B-3.2XN5G/TR	SRMXX	Tape and Reel, 3000
		SC70-4 (R)	-40°C to +125°C	SGM828B-3.2XC4G/TR	SRNXX	Tape and Reel, 3000
SGM828B-3.3	3.3	SOT-23-5	-40°C to +125°C	SGM828B-3.3XN5G/TR	SRPXX	Tape and Reel, 3000
		SC70-4 (R)	-40°C to +125°C	SGM828B-3.3XC4G/TR	SRQXX	Tape and Reel, 3000

**PACKAGE/ORDERING INFORMATION (continued)**

MODEL	DETECTION VOLTAGE (V)	PACKAGE DESCRIPTION	SPECIFIED TEMPERATURE RANGE	ORDERING NUMBER	PACKAGE MARKING	PACKING OPTION
SGM828B-3.4	3.4	SOT-23-5	-40°C to +125°C	SGM828B-3.4XN5G/TR	SRRXX	Tape and Reel, 3000
		SC70-4 (R)	-40°C to +125°C	SGM828B-3.4XC4G/TR	SRSXX	Tape and Reel, 3000
SGM828B-3.5	3.5	SOT-23-5	-40°C to +125°C	SGM828B-3.5XN5G/TR	SRTXX	Tape and Reel, 3000
		SC70-4 (R)	-40°C to +125°C	SGM828B-3.5XC4G/TR	SRUXX	Tape and Reel, 3000
SGM828B-3.6	3.6	SOT-23-5	-40°C to +125°C	SGM828B-3.6XN5G/TR	SRVXX	Tape and Reel, 3000
		SC70-4 (R)	-40°C to +125°C	SGM828B-3.6XC4G/TR	SRWXX	Tape and Reel, 3000
SGM828B-3.7	3.7	SOT-23-5	-40°C to +125°C	SGM828B-3.7XN5G/TR	SRXXX	Tape and Reel, 3000
		SC70-4 (R)	-40°C to +125°C	SGM828B-3.7XC4G/TR	SRYXX	Tape and Reel, 3000
SGM828B-3.8	3.8	SOT-23-5	-40°C to +125°C	SGM828B-3.8XN5G/TR	SRZXX	Tape and Reel, 3000
		SC70-4 (R)	-40°C to +125°C	SGM828B-3.8XC4G/TR	SSGXX	Tape and Reel, 3000
SGM828B-3.9	3.9	SOT-23-5	-40°C to +125°C	SGM828B-3.9XN5G/TR	SSHXX	Tape and Reel, 3000
		SC70-4 (R)	-40°C to +125°C	SGM828B-3.9XC4G/TR	SSIXX	Tape and Reel, 3000
SGM828B-4.0	4.0	SOT-23-5	-40°C to +125°C	SGM828B-4.0XN5G/TR	SSJXX	Tape and Reel, 3000
		SC70-4 (R)	-40°C to +125°C	SGM828B-4.0XC4G/TR	SSKXX	Tape and Reel, 3000
SGM828B-4.1	4.1	SOT-23-5	-40°C to +125°C	SGM828B-4.1XN5G/TR	SSLXX	Tape and Reel, 3000
		SC70-4 (R)	-40°C to +125°C	SGM828B-4.1XC4G/TR	SSMXX	Tape and Reel, 3000
SGM828B-4.2	4.2	SOT-23-5	-40°C to +125°C	SGM828B-4.2XN5G/TR	SSNXX	Tape and Reel, 3000
		SC70-4 (R)	-40°C to +125°C	SGM828B-4.2XC4G/TR	SSPXX	Tape and Reel, 3000
SGM828B-4.3	4.3	SOT-23-5	-40°C to +125°C	SGM828B-4.3XN5G/TR	SSQXX	Tape and Reel, 3000
		SC70-4 (R)	-40°C to +125°C	SGM828B-4.3XC4G/TR	SSRXX	Tape and Reel, 3000
SGM828B-4.4	4.4	SOT-23-5	-40°C to +125°C	SGM828B-4.4XN5G/TR	SSSXX	Tape and Reel, 3000
		SC70-4 (R)	-40°C to +125°C	SGM828B-4.4XC4G/TR	SSTXX	Tape and Reel, 3000
SGM828B-4.5	4.5	SOT-23-5	-40°C to +125°C	SGM828B-4.5XN5G/TR	SSUXX	Tape and Reel, 3000
		SC70-4 (R)	-40°C to +125°C	SGM828B-4.5XC4G/TR	SSVXX	Tape and Reel, 3000
SGM828B-4.6	4.6	SOT-23-5	-40°C to +125°C	SGM828B-4.6XN5G/TR	SSWXX	Tape and Reel, 3000
		SC70-4 (R)	-40°C to +125°C	SGM828B-4.6XC4G/TR	SSXXX	Tape and Reel, 3000
SGM828B-4.7	4.7	SOT-23-5	-40°C to +125°C	SGM828B-4.7XN5G/TR	SSYXX	Tape and Reel, 3000
		SC70-4 (R)	-40°C to +125°C	SGM828B-4.7XC4G/TR	SSZXX	Tape and Reel, 3000
SGM828B-4.8	4.8	SOT-23-5	-40°C to +125°C	SGM828B-4.8XN5G/TR	STGXX	Tape and Reel, 3000
		SC70-4 (R)	-40°C to +125°C	SGM828B-4.8XC4G/TR	STHXX	Tape and Reel, 3000



**PACKAGE/ORDERING INFORMATION (continued)**

MODEL	DETECTION VOLTAGE (V)	PACKAGE DESCRIPTION	SPECIFIED TEMPERATURE RANGE	ORDERING NUMBER	PACKAGE MARKING	PACKING OPTION
SGM828B-4.9	4.9	SOT-23-5	-40°C to +125°C	SGM828B-4.9XN5G/TR	STIXX	Tape and Reel, 3000
		SC70-4 (R)	-40°C to +125°C	SGM828B-4.9XC4G/TR	STJXX	Tape and Reel, 3000
SGM828B-5.0	5.0	SOT-23-5	-40°C to +125°C	SGM828B-5.0XN5G/TR	STKXX	Tape and Reel, 3000
		SC70-4 (R)	-40°C to +125°C	SGM828B-5.0XC4G/TR	STLXX	Tape and Reel, 3000
SGM828B-5.1	5.1	SOT-23-5	-40°C to +125°C	SGM828B-5.1XN5G/TR	STMXX	Tape and Reel, 3000
		SC70-4 (R)	-40°C to +125°C	SGM828B-5.1XC4G/TR	STNXX	Tape and Reel, 3000
SGM828B-5.2	5.2	SOT-23-5	-40°C to +125°C	SGM828B-5.2XN5G/TR	STPXX	Tape and Reel, 3000
		SC70-4 (R)	-40°C to +125°C	SGM828B-5.2XC4G/TR	STQXX	Tape and Reel, 3000
SGM828B-5.3	5.3	SOT-23-5	-40°C to +125°C	SGM828B-5.3XN5G/TR	STRXX	Tape and Reel, 3000
		SC70-4 (R)	-40°C to +125°C	SGM828B-5.3XC4G/TR	STSXX	Tape and Reel, 3000
SGM828B-5.4	5.4	SOT-23-5	-40°C to +125°C	SGM828B-5.4XN5G/TR	STTXX	Tape and Reel, 3000
		SC70-4 (R)	-40°C to +125°C	SGM828B-5.4XC4G/TR	STUXX	Tape and Reel, 3000
SGM828B-5.5	5.5	SOT-23-5	-40°C to +125°C	SGM828B-5.5XN5G/TR	STVXX	Tape and Reel, 3000
		SC70-4 (R)	-40°C to +125°C	SGM828B-5.5XC4G/TR	STWXX	Tape and Reel, 3000
SGM828B-5.6	5.6	SOT-23-5	-40°C to +125°C	SGM828B-5.6XN5G/TR	STXXX	Tape and Reel, 3000
		SC70-4 (R)	-40°C to +125°C	SGM828B-5.6XC4G/TR	STYXX	Tape and Reel, 3000
SGM828B-5.7	5.7	SOT-23-5	-40°C to +125°C	SGM828B-5.7XN5G/TR	STZXX	Tape and Reel, 3000
		SC70-4 (R)	-40°C to +125°C	SGM828B-5.7XC4G/TR	SUGXX	Tape and Reel, 3000
SGM828B-5.8	5.8	SOT-23-5	-40°C to +125°C	SGM828B-5.8XN5G/TR	SUHXX	Tape and Reel, 3000
		SC70-4 (R)	-40°C to +125°C	SGM828B-5.8XC4G/TR	SUIXX	Tape and Reel, 3000
SGM828B-5.9	5.9	SOT-23-5	-40°C to +125°C	SGM828B-5.9XN5G/TR	SUJXX	Tape and Reel, 3000
		SC70-4 (R)	-40°C to +125°C	SGM828B-5.9XC4G/TR	SUKXX	Tape and Reel, 3000
SGM828B-6.0	6.0	SOT-23-5	-40°C to +125°C	SGM828B-6.0XN5G/TR	SULXX	Tape and Reel, 3000
		SC70-4 (R)	-40°C to +125°C	SGM828B-6.0XC4G/TR	SUMXX	Tape and Reel, 3000

NOTE: If you need push-pull output devices, please contact the factory.

**MARKING INFORMATION**

NOTE: XX = Date Code.

**YYY X X**

— Date Code - Week  
— Date Code - Year  
— Serial Number

Green (RoHS & HSF): SG Micro Corp defines "Green" to mean Pb-Free (RoHS compatible) and free of halogen substances. If you have additional comments or questions, please contact your SGMICRO representative directly.

**ABSOLUTE MAXIMUM RATINGS**

Input Voltage Range .....	GND - 0.3V to 12V
Output Voltage, V <sub>OUT</sub> .....	GND - 0.3V to 12V
Output Current, I <sub>OUT</sub> .....	50mA
Package Thermal Resistance	
SOT-23-5, $\theta_{JA}$ .....	260°C/W
SC70-4 (R), $\theta_{JA}$ .....	672°C/W
Junction Temperature .....	+150°C
Storage Temperature Range.....	-65°C to +150°C
Lead Temperature (Soldering, 10s) .....	+260°C
ESD Susceptibility	
HBM.....	2000V
CDM .....	1000V

**RECOMMENDED OPERATING CONDITIONS**

Operating Junction Temperature Range .....	-40°C to +125°C
--	-----------------

**OVERSTRESS CAUTION**

Stresses beyond those listed in Absolute Maximum Ratings may cause permanent damage to the device. Exposure to absolute maximum rating conditions for extended periods may affect reliability. Functional operation of the device at any conditions beyond those indicated in the Recommended Operating Conditions section is not implied.

**ESD SENSITIVITY CAUTION**

This integrated circuit can be damaged if ESD protections are not considered carefully. SGMICRO recommends that all integrated circuits be handled with appropriate precautions. Failure to observe proper handling and installation procedures can cause damage. ESD damage can range from subtle performance degradation to complete device failure. Precision integrated circuits may be more susceptible to damage because even small parametric changes could cause the device not to meet the published specifications.

**DISCLAIMER**

SG Micro Corp reserves the right to make any change in circuit design, or specifications without prior notice.

**PIN CONFIGURATIONS**

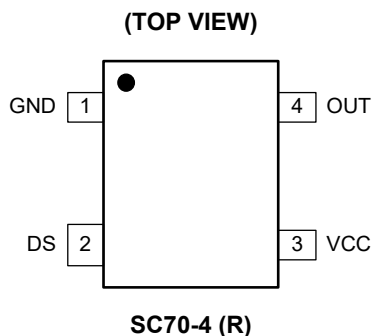
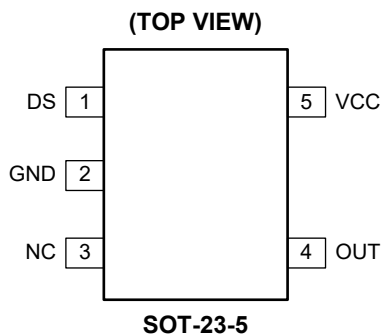

**PIN DESCRIPTION**

PIN		NAME	FUNCTION
SOT-23-5	SC70-4 (R)		
1	2	DS	On/Off Switch for Delay Time.
2	1	GND	Ground Pin.
3	—	NC	Not Connected.
4	4	OUT	Active-Low Output Pin.
5	3	VCC	Power Supply Pin.

## ELECTRICAL CHARACTERISTICS

(T<sub>J</sub> = -40°C to +125°C, typical values are at T<sub>J</sub> = +25°C, unless otherwise noted.)

PARAMETER	SYMBOL	CONDITIONS		MIN	TYP	MAX	UNITS
Detection Voltage Accuracy	-V <sub>DET</sub>	Test Circuit 1	T <sub>J</sub> = +25°C	-1.5		1.5	%
			T <sub>J</sub> = -40°C to +125°C	-2		-2	
Hysteresis Accuracy	V <sub>HYS</sub>	Test Circuit 1	T <sub>J</sub> = +25°C	0.85	1.5	2.15	%
			T <sub>J</sub> = -40°C to +125°C	0.75	1.5	2.25	
Operating Voltage	V <sub>CC</sub>	Test Circuit 1		0.95		10	V
Detection Voltage Temperature Characteristics <sup>(2)</sup>	$\frac{\Delta(-V_{DET})}{\Delta T_J \times (-V_{DET})}$	T <sub>J</sub> = -40°C to +125°C, Test Circuit 1			±30	±250	ppm/°C
Current Consumption	I <sub>SS</sub>	Test Circuit 1	V <sub>CC</sub> = 3.5V, -V <sub>DET</sub> = 1.5V to 2.6V		1.0	2.1	μA
			V <sub>CC</sub> = 4.5V, -V <sub>DET</sub> = 2.7V to 3.9V		1.1	2.2	
			V <sub>CC</sub> = 6.0V, -V <sub>DET</sub> = 4.0V to 5.6V		1.2	2.4	
			V <sub>CC</sub> = 7.5V, -V <sub>DET</sub> = 5.7V to 6.0V		1.3	2.5	
Output Current	I <sub>OUT</sub>	Test Circuit 2, V <sub>OUT</sub> = 0.5V	V <sub>CC</sub> = 1.2V, -V <sub>DET</sub> = 1.5V to 6.0V	0.80	3.15		mA
			V <sub>CC</sub> = 2.4V, -V <sub>DET</sub> = 2.7V to 6.0V	4.00	7.50		
Leakage Current	I <sub>LEAK</sub>	V <sub>CC</sub> = 10V, V <sub>OUT</sub> = 10V, Test Circuit 2				100	nA
Delay Time 1	t <sub>D1</sub>	V <sub>CC</sub> = (-V <sub>DET</sub> ) × 0.9 to (-V <sub>DET</sub> ) × 1.1, DS pin low, Test Circuit 3	SGM826B	25	50	70	ms
			SGM827B	50	100	140	
			SGM828B	100	200	280	
Delay Time 2	t <sub>D2</sub>	V <sub>CC</sub> = (-V <sub>DET</sub> ) × 0.9 to (-V <sub>DET</sub> ) × 1.1, DS pin high, Test Circuit 1				240	μs
Input Voltage	V <sub>SH</sub>	DS pin, V <sub>CC</sub> = 6.0V, Test Circuit 4		1.1			V
	V <sub>SL</sub>	DS pin, V <sub>CC</sub> = 6.0V, Test Circuit 4				0.3	

**NOTE:**

1. The temperature change ratio of the detection voltage can be calculated by:

$$\frac{\Delta(-V_{DET})}{\Delta T_J} [\text{mV} / ^\circ\text{C}]^{(1)} = -V_{DET} (\text{TYP}) [\text{V}]^{(2)} \times \frac{\Delta(-V_{DET})}{\Delta T_J \times (-V_{DET})} [\text{ppm} / ^\circ\text{C}]^{(3)} / 1000$$

Where:  $\frac{\Delta(-V_{DET})}{\Delta T_J}$  is the temperature change ratio of the detection voltage, -V<sub>DET</sub> (TYP) is the specified detection voltage, and

$\frac{\Delta(-V_{DET})}{\Delta T_J \times (-V_{DET})}$  is the detection voltage temperature coefficient.

**TEST CIRCUITS**

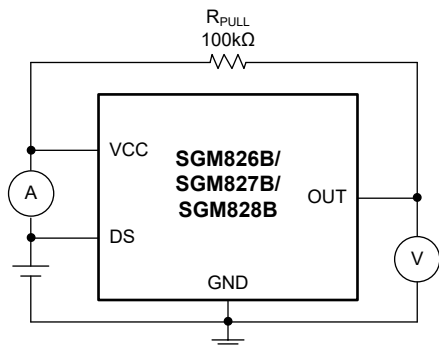

**Test Circuit 1**

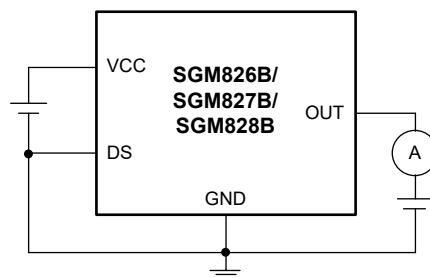

**Test Circuit 2**

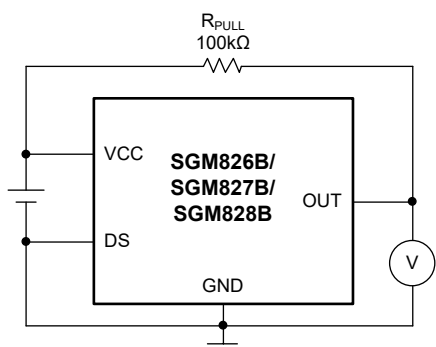

**Test Circuit 3**

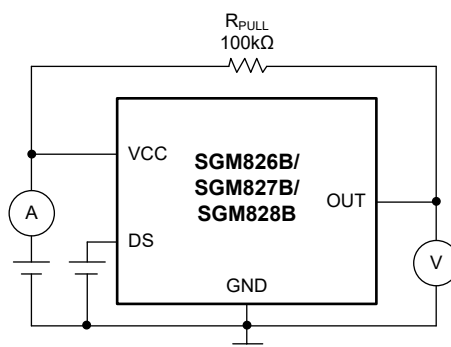

**Test Circuit 4**

**TYPICAL PERFORMANCE CHARACTERISTICS**

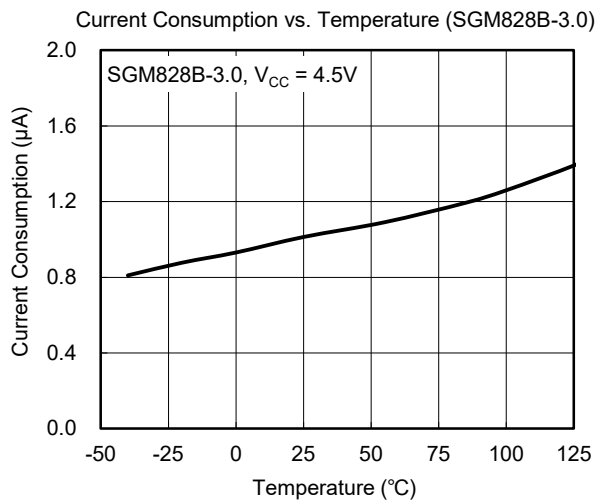
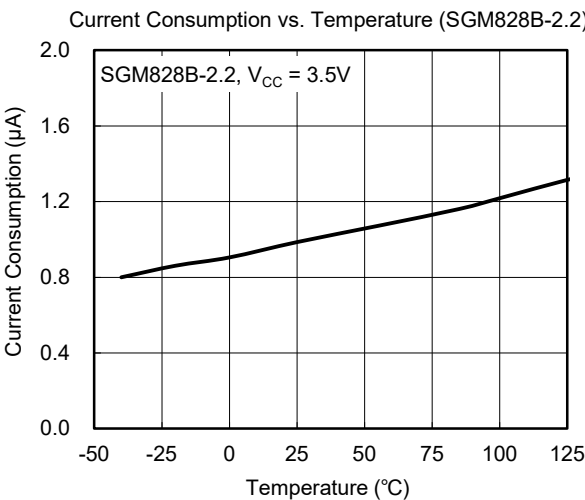
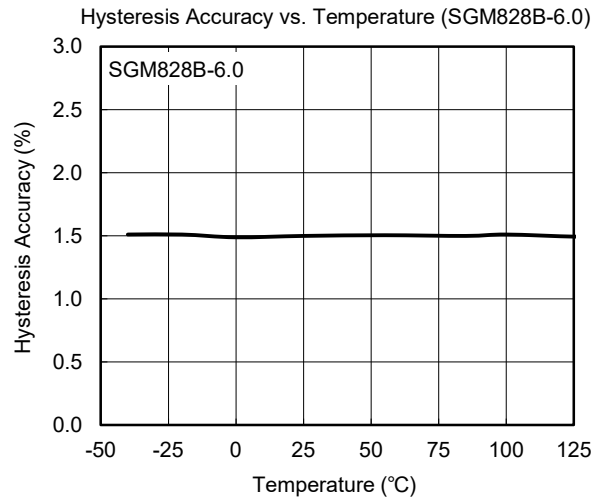
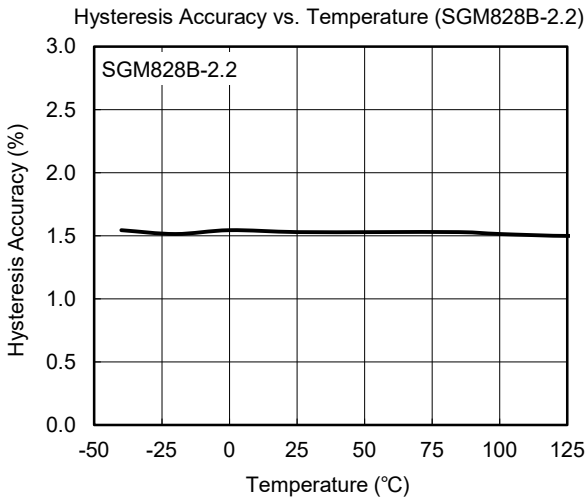
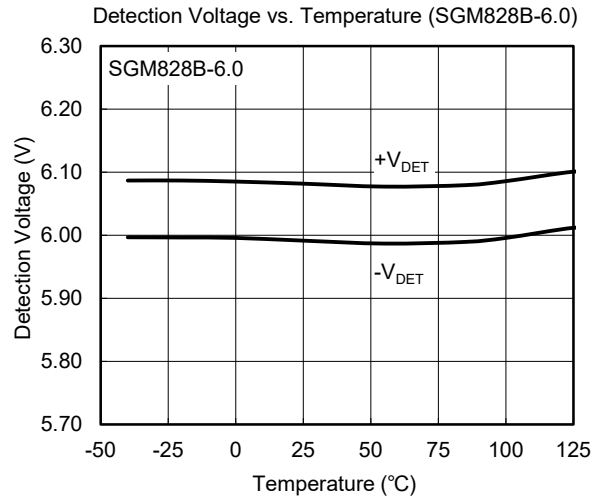
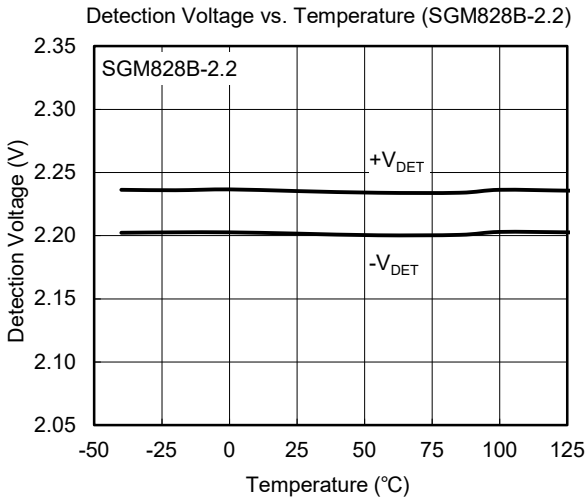

**TYPICAL PERFORMANCE CHARACTERISTICS (continued)**

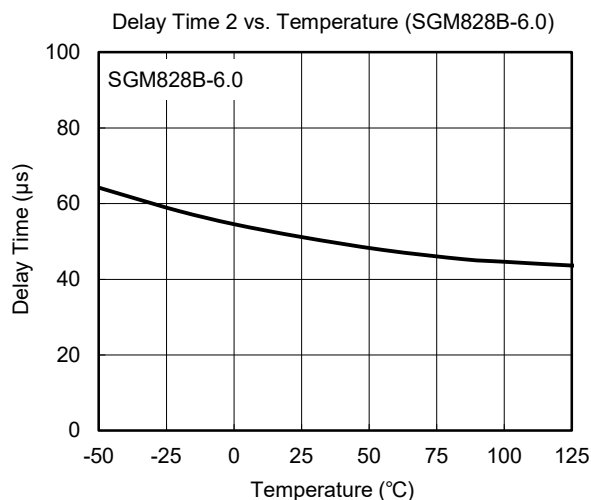
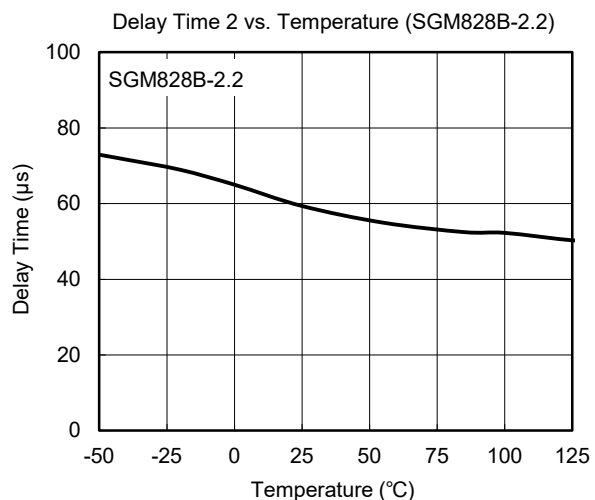
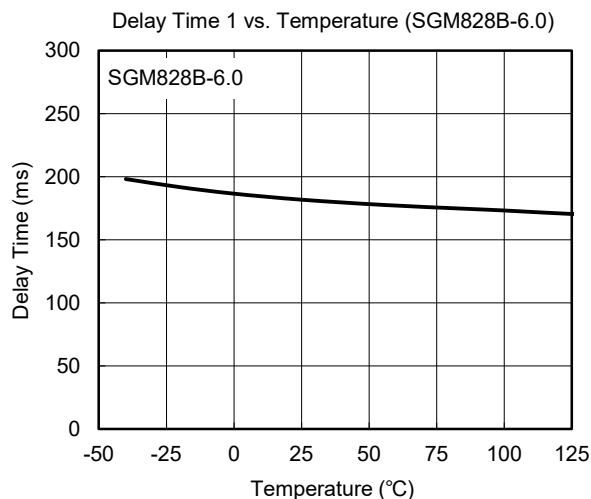
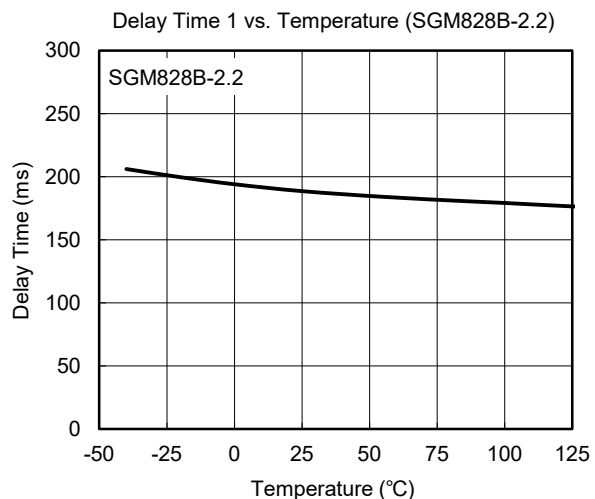
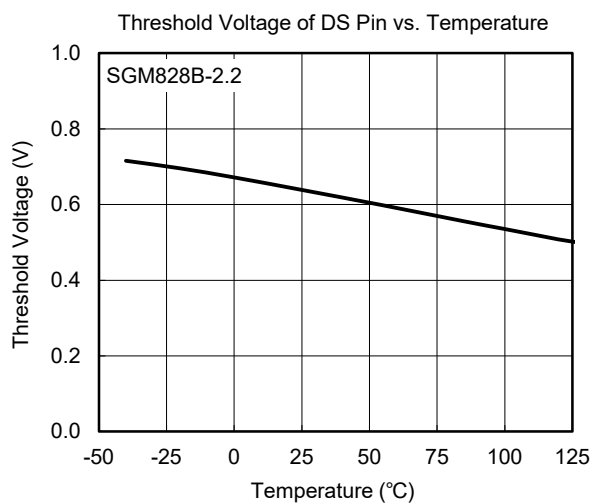
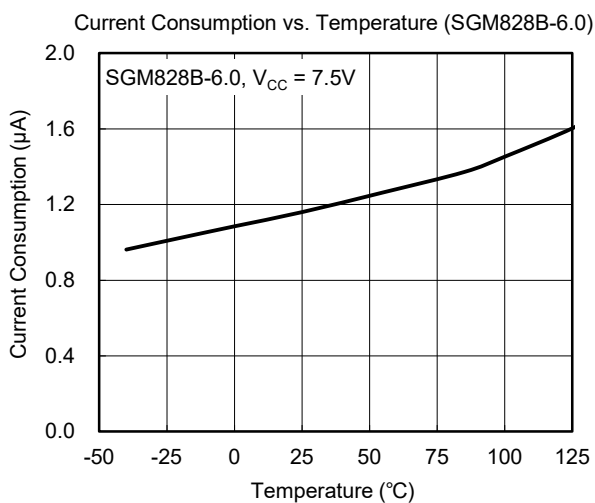

**TYPICAL PERFORMANCE CHARACTERISTICS (continued)**

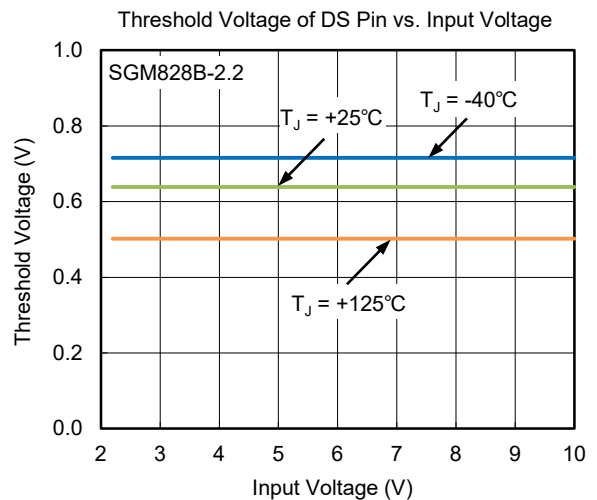
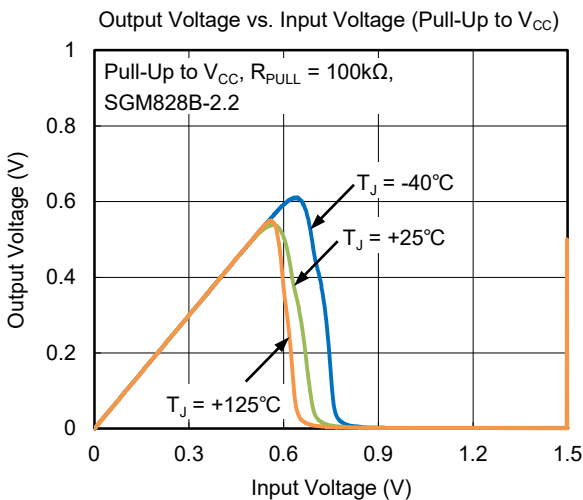
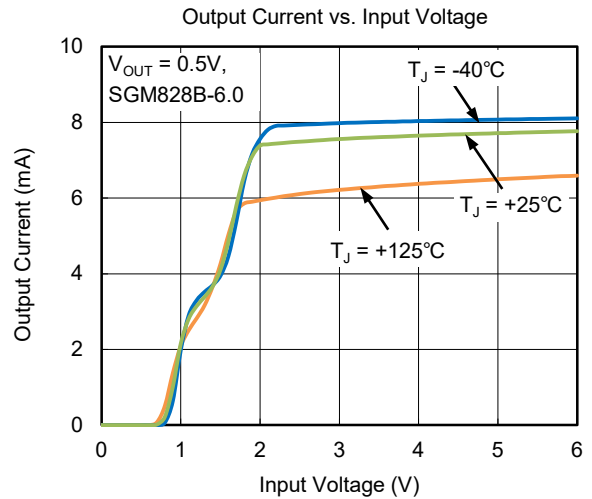
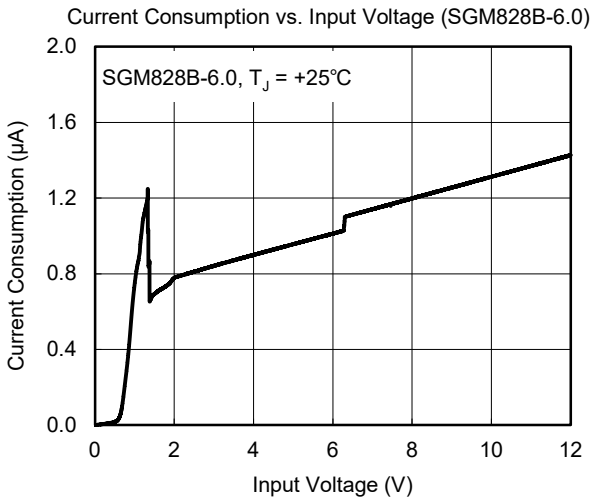
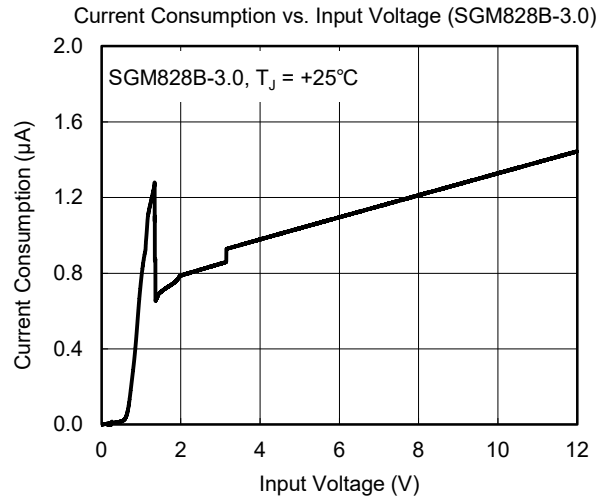
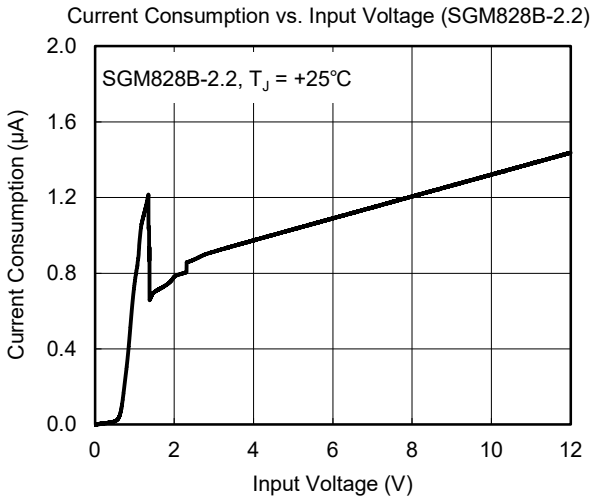



**TYPICAL PERFORMANCE CHARACTERISTICS (continued)**

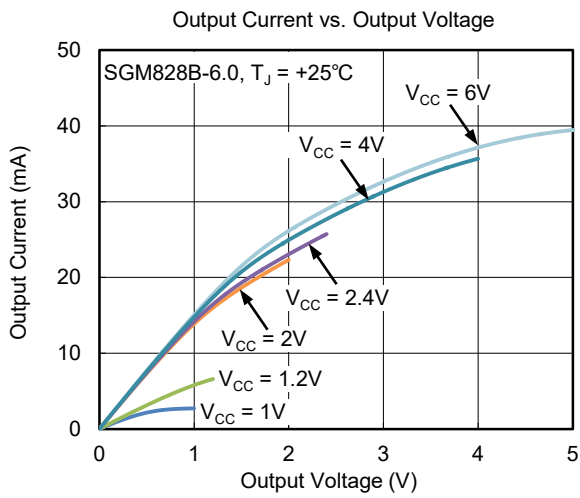

## **REVISION HISTORY**

NOTE: Page numbers for previous revisions may differ from page numbers in the current version.

**Changes from Original (JUNE 2021) to REV.A**

**Page**

---

Changed from product preview to production data.....All

---

# PACKAGE INFORMATION

## PACKAGE OUTLINE DIMENSIONS

### SOT-23-5

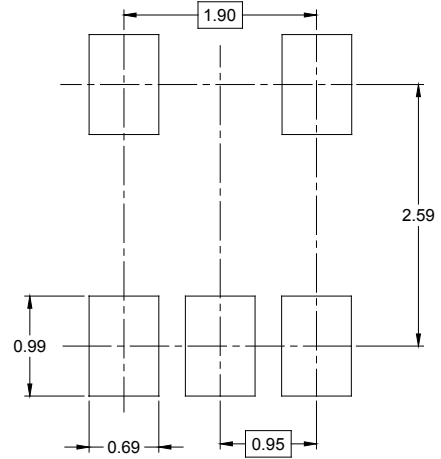
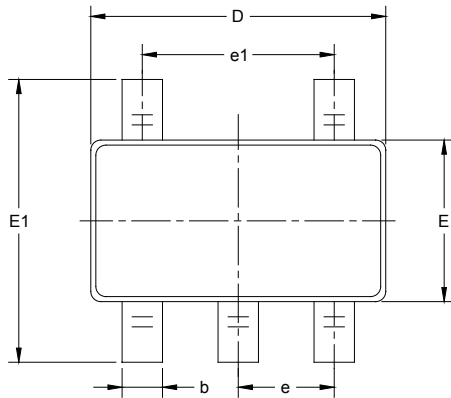

RECOMMENDED LAND PATTERN (Unit: mm)

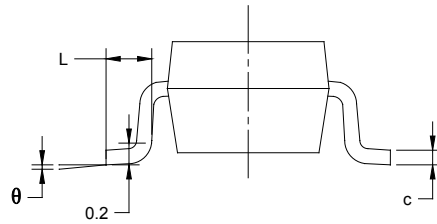

Symbol	Dimensions In Millimeters		Dimensions In Inches	
	MIN	MAX	MIN	MAX
A	1.050	1.250	0.041	0.049
A1	0.000	0.100	0.000	0.004
A2	1.050	1.150	0.041	0.045
b	0.300	0.500	0.012	0.020
c	0.100	0.200	0.004	0.008
D	2.820	3.020	0.111	0.119
E	1.500	1.700	0.059	0.067
E1	2.650	2.950	0.104	0.116
e	0.950 BSC		0.037 BSC	
e1	1.900 BSC		0.075 BSC	
L	0.300	0.600	0.012	0.024
$\theta$	0°	8°	0°	8°

PACKAGE OUTLINE DIMENSIONS

SC70-4 (R)

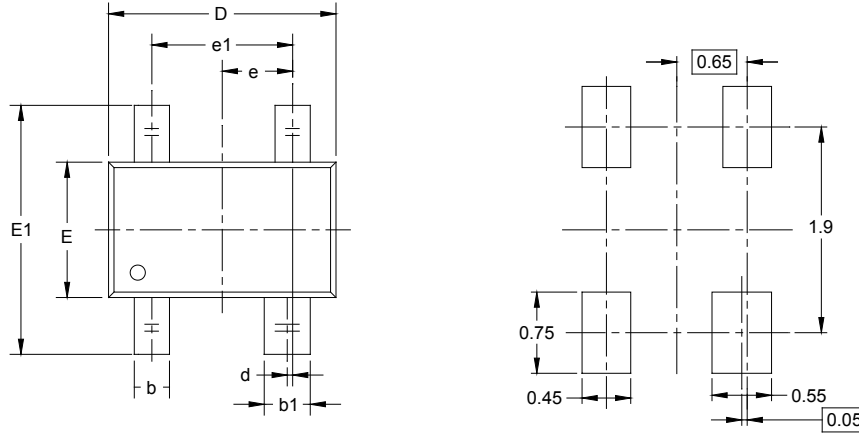

RECOMMENDED LAND PATTERN (Unit: mm)

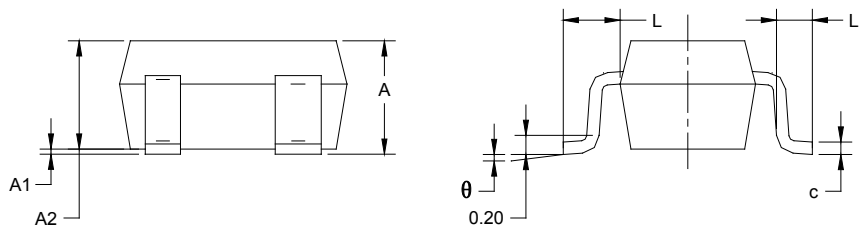

Symbol	Dimensions In Millimeters		Dimensions In Inches	
	MIN	MAX	MIN	MAX
A	0.900	1.100	0.035	0.043
A1	0.000	0.100	0.000	0.004
A2	0.900	1.000	0.035	0.039
b	0.250	0.400	0.010	0.016
b1	0.350	0.500	0.014	0.020
c	0.080	0.150	0.003	0.006
d	0.050TYP		0.002TYP	
D	2.000	2.200	0.079	0.087
E	1.150	1.350	0.045	0.053
E1	2.150	2.450	0.085	0.096
e	0.65 TYP		0.026 TYP	
e1	1.200	1.400	0.047	0.055
L	0.525 REF		0.021 REF	
L1	0.260	0.460	0.010	0.018
θ	0°	8°	0°	8°

## TAPE AND REEL INFORMATION

### REEL DIMENSIONS



### TAPE DIMENSIONS



NOTE: The picture is only for reference. Please make the object as the standard.

### KEY PARAMETER LIST OF TAPE AND REEL

Package Type	Reel Diameter	Reel Width W1 (mm)	A0 (mm)	B0 (mm)	K0 (mm)	P0 (mm)	P1 (mm)	P2 (mm)	W (mm)	Pin1 Quadrant
SOT-23-5	7"	9.5	3.20	3.20	1.40	4.0	4.0	2.0	8.0	Q3
SC70-4 (R)	7"	9.5	3.20	2.80	1.30	4.0	4.0	2.0	8.0	Q3

000001

# PACKAGE INFORMATION

## CARTON BOX DIMENSIONS



NOTE: The picture is only for reference. Please make the object as the standard.

## KEY PARAMETER LIST OF CARTON BOX

Reel Type	Length (mm)	Width (mm)	Height (mm)	Pizza/Carton
7" (Option)	368	227	224	8
7"	442	410	224	18

DD0002