

Automotive Relay Series 汽车继电器系列 -- JQX-V5H

FEATURES特点

- Up to 80A contact switching capability
高达80A触点切换能力
- Plastic and flux proof are available
塑封型和防焊剂型可供选择
- Magnetic arc blowing technology
磁吹弧技术
- Outline dimensions (26.0*26.0*22.7) mm.
外形尺寸 (26.0*26.0*22.7) mm。

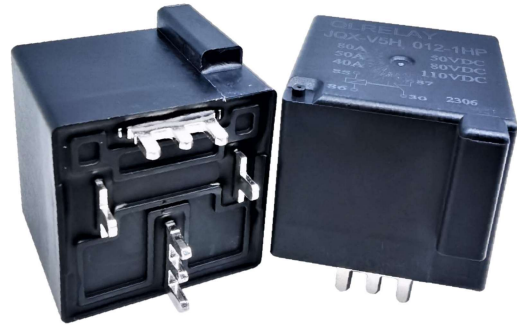

CONTACT PARAMETERS触点参数(at 23°C)

Relay Type 产品型号	JQX-V5H XXX1	JQX-V5H XXX3
Contact Form 触点形式	A-1组常开 B-1组常闭	A-1组常开 B-1组常闭
Rating Load (Resistive) 额定负载 (阻性)	1A: 70A/120VDC 30A/220VDC 1B: 50A/120VDC	1A: 40A/120VDC 1B: 30A/120VDC
Max. Switching Current 最大切换电流	80A	40A
Max. Switching Voltage 最大切换电压	220VDC	120VDC
Max. Switching Power 最大切换功率	8400W	4800W

CHARACTERISTICS性能参数

Contact Materials 触点材料	Ag Alloy 银合金	
Contact Resistance 接触电阻	100mΩ Max.	
Operate Time 吸合时间	10msec. Max.	
Release Time 释放时间	10msec. Max.	
Insulation Resistance 绝缘电阻	100MΩ Min. (DC500V)	
Initial Dielectric Strength 介质耐压	Between open contacts: 触点与触点间:	AC750V, 50/60Hz 1Min.
	Between contacts and coil: 触点与线圈间:	AC750V, 50/60Hz 1Min.
Vibration Resistance 抗振动	Damage limits: 耐久:	10~55Hz Double Amplitude 双振幅3.0mm
	Malfunction: 误动作:	10~55Hz Double Amplitude 双振幅3.0mm
Shock Resistance 抗冲击	Damage limits: 耐久:	100G Min.
	Malfunction: 误动作:	18G Min.
Life 寿命	Mechanical Life (18 000 per hour) 机械寿命 (每小时18 000次)	1 × 10 ⁷
	Electrical Life (30 per hour) 电气寿命 (每小时30次)	1 Form A NO: 2 × 10 ⁴ 1 Form B NC: 1 × 10 ⁴
Ambient Temperature 环境温度	-40°C ~ +85°C (No condensation) (不冷凝)	
Unit Weight 单位重量	约Approx 28.6g	

COIL RATINGS (at 23°C) 线圈参数 (在 23°C)

额定电压	动作电压	释放电压	最大线圈电压	额定电流	线圈电阻
VDC	VDC	VDC	VDC	× (1 ± 10%) mA	× (1 ± 10%) Ω
12	≤ 7.2	≥ 1.2	20.2	133.3	90
24	≤ 14.4	≥ 2.4	40.5	66.7	360
48	≤ 28.8	≥ 4.8	81	33.3	1440
72	≤ 43.2	≥ 7.2	121.2	22.2	3240

备注： 线圈额定功率约1.6W，其它线圈功耗请联络业务。

ORDERING INFORMATION 订货标记

JQX-V5H 012 - 1 H P R N 3 (XXX)									
1	2	3	4	5	6	7	8	9	
1. Model Number 基本型号 JQX-V5H	2. Coil Voltage 线圈规格 (VDC): DC12V, DC24V, DC48V, DC72V		3. Number of Pole: 1 : Single pole 开关型式: 1 — 一组开关		4. Contact form: H -1Form A, D -1Form B 触点形式: H -1组常开, D -1组常闭		5. Induces foot position: P - PCB Board Terminal Nil - Solder Lug Terminal 引出脚形式: P—PCB引脚 无—快捷端子引脚		6. Options: Nil-Standard R-Coil paralel resistor D1/D2 - Coil paralel Diode (详见元件表) 类型: 无—标准型 R—线圈并联电阻 D1/D2—线圈并联二极管
			7. Coil Power: Nil-1.6W, N - 2.0W 线圈功率: 无-1.6W, N - 2.0W		8. Induces foot position: 1 or Nil - 1 foot position 3 - 2 foot position 引出脚脚位: 1 or 无 — 1型脚 3 — 2型脚		9. Customer Special Code :XXX- Customer Special Requirements No - Standard Type 客户特性号: XXX-客户特殊要求, 无-标准型		

OUTLINE DIMENSIONS (UNIT:mm) 外形尺寸 (单位: mm)

1 型脚

PCB脚外形图

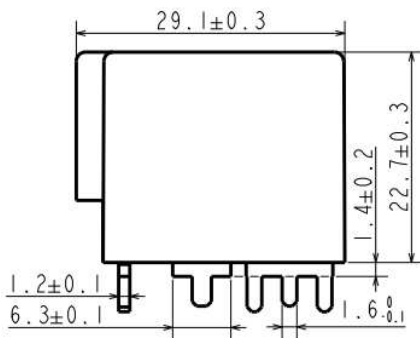

底视图(光背 pcb 脚)

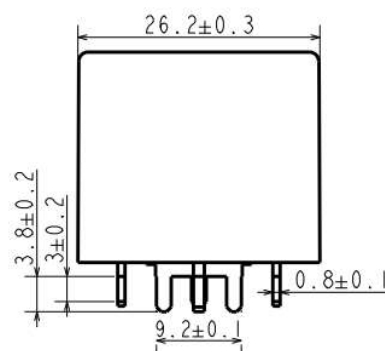

孔位图(光背 pcb 脚)

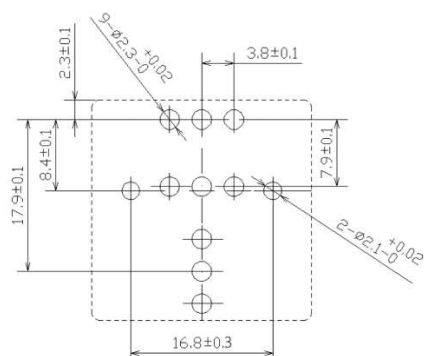
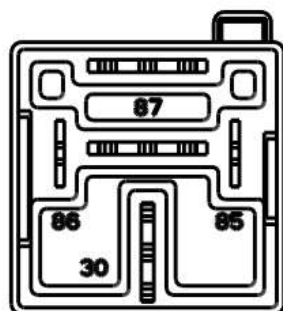

光背长脚外形图

底视图(光背长脚)

孔位图(光背长脚)

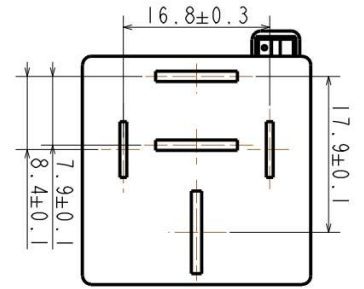
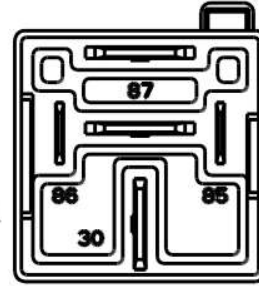
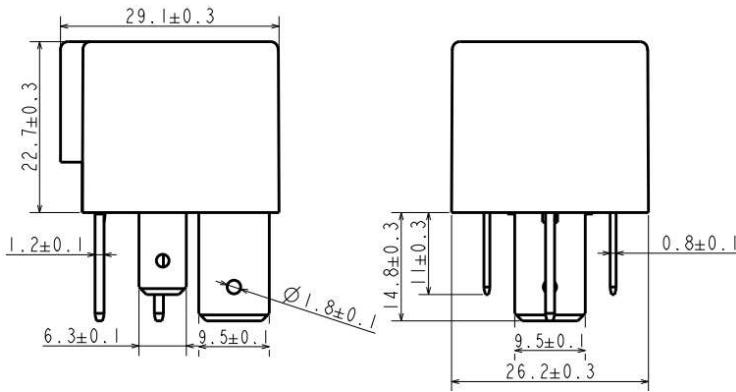

铁背长脚外形图

底视图(铁背长脚)

孔位图(铁背长脚)

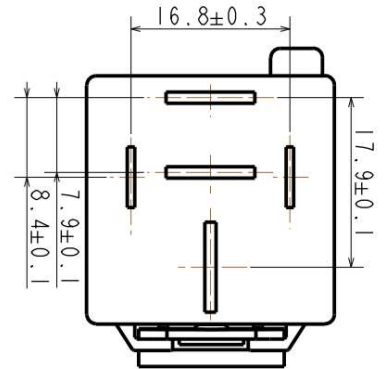
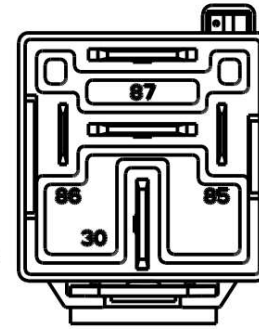
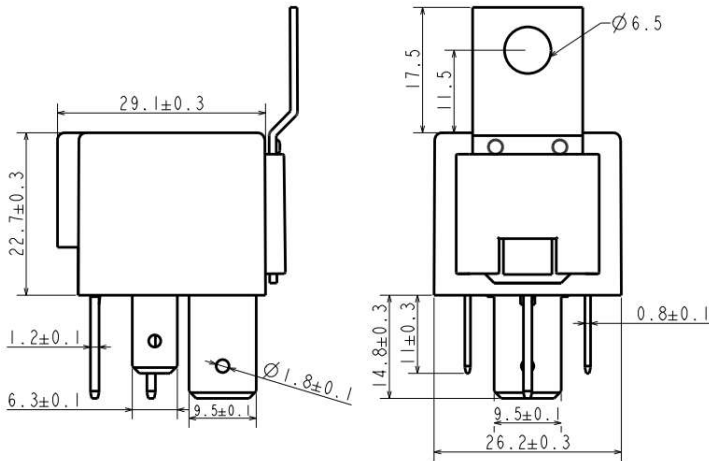

备注: 1) 产品部分外形尺寸未注明公差, 当外形尺寸 $\leq 1\text{mm}$ 时, 公差为 $\pm 0.2\text{mm}$; 当外形尺寸为 $1\sim 5\text{mm}$ 时, 公差为 $\pm 0.3\text{mm}$; 当外形尺寸 $> 5\text{mm}$ 时, 公差为 $\pm 0.4\text{mm}$ 。

2) 安装孔未注明公差得均为 $\pm 0.1\text{mm}$ 。

备注:	A型无87a脚 Form A: Without 87a terminal
Remark:	D型无87脚 Form D: Without 87 terminal

标准型

带电阻型

带二极管型 (D2)

带二极管型 (D1)

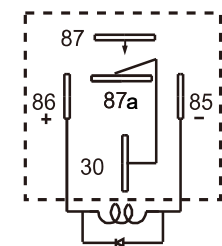
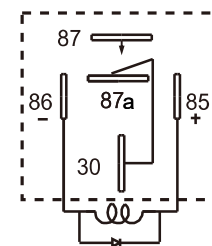
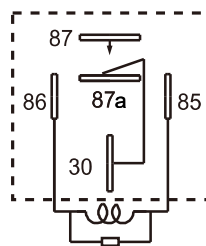
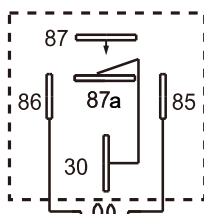

接线图 (底视图)

2 型脚 光背长脚外形图

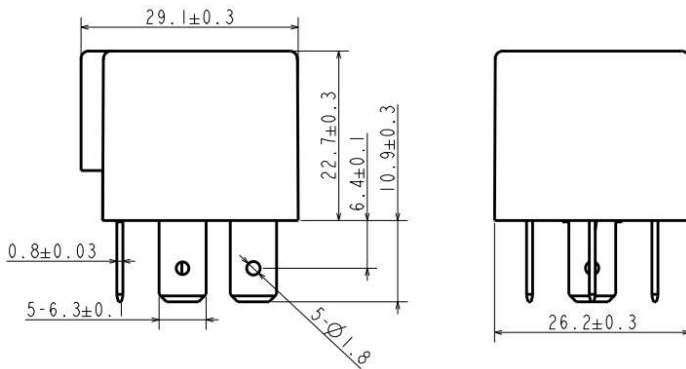

底视图(光背长脚)

孔位图(光背长脚)

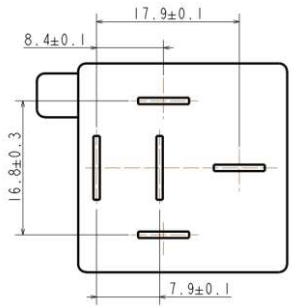
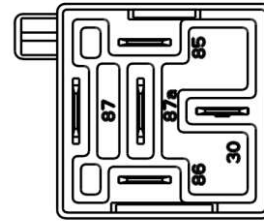

光背 PCB 外形图

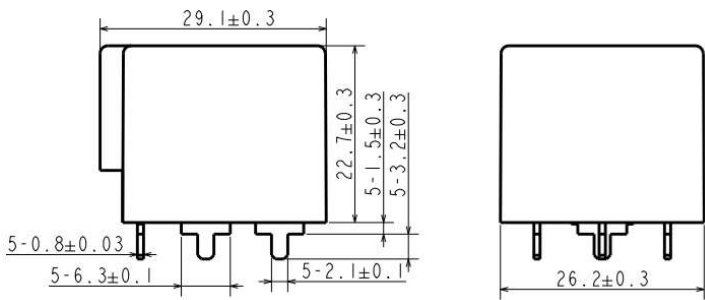

底视图(光背 PCB 脚)

孔位图(光背 PCB 脚)

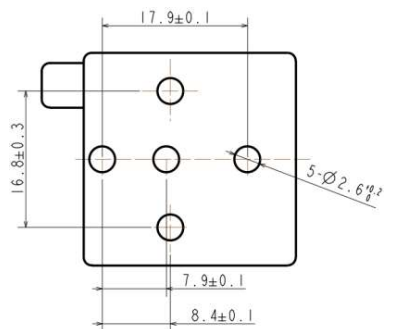
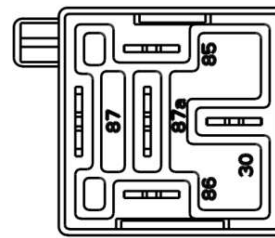

铁背长脚外形图

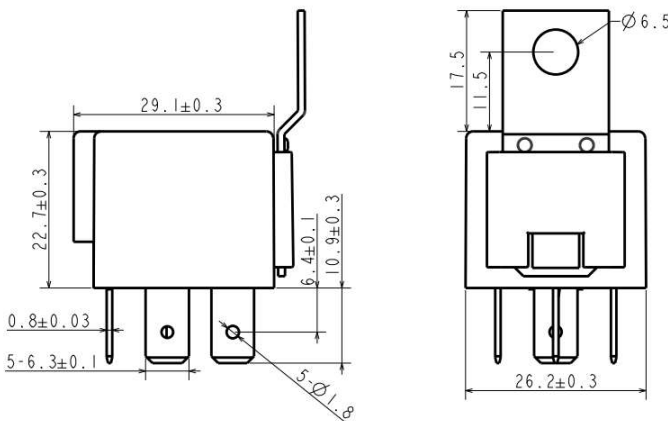

底视图(铁背长脚)

孔位图(铁背长脚)

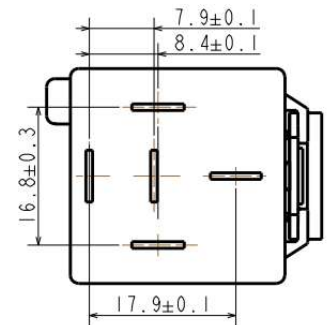
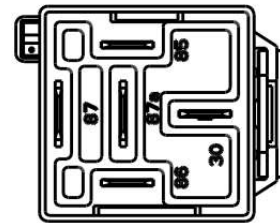

备注: 1) 产品部分外形尺寸未注明公差, 当外形尺寸 $\leq 1\text{mm}$ 时, 公差为 $\pm 0.2\text{mm}$; 当外形尺寸为 $1 \sim 5\text{mm}$ 时, 公差为 $\pm 0.3\text{mm}$; 当外形尺寸 $> 5\text{mm}$ 时, 公差为 $\pm 0.4\text{mm}$ 。

2) 安装孔未注明公差得均为 $\pm 0.1\text{mm}$ 。

备注:
Remark:

A型无87a脚 Form A: Without 87a terminal

D型无87脚 Form D: Without 87 terminal

标准型

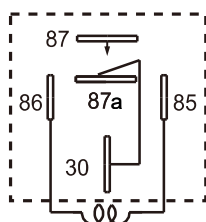

带电阻型

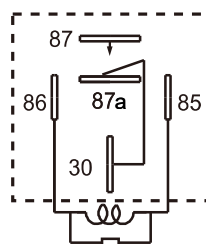

带二极管型 (D2)

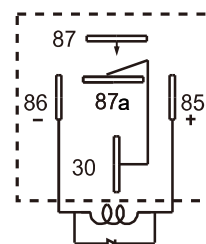

带二极管型 (D1)

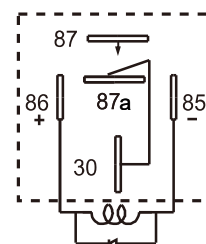

接线图 (底视图)