



# SGM8278-2

## Low Noise, High Voltage, Rail-to-Rail I/O Operational Amplifier

---

### GENERAL DESCRIPTION

The SGM8278-2 is a dual, low noise, precision, high voltage operational amplifier, which can operate from 3V to 36V single supply or from  $\pm 1.5V$  to  $\pm 18V$  dual power supplies. It provides rail-to-rail input with a wide input common mode voltage range and rail-to-rail output voltage swing.

The SGM8278-2 provides high slew rate, low noise, low offset, drift and bias current.

The SGM8278-2 is available in Green SOIC-8, MSOP-8, TDFN-2x2-8AL, TDFN-3x3-8BL and WLCSP-1.57x1.57-8B packages. It is specified over the extended  $-40^{\circ}C$  to  $+125^{\circ}C$  temperature range.

### FEATURES

- Rail-to-Rail Input and Output
- Support Single or Dual Power Supplies
- Wide Input Common Mode and Differential Voltage Ranges
- Low Input Offset Voltage: 2mV (MAX)
- Low Input Bias Current
- Low Input Offset Current
- High Input Impedance
- High Output Current: 95mA (Able to Drive  $32\Omega$  Load)
- Output Short-Circuit Protection
- Low Noise:  $15nV/\sqrt{Hz}$  at 1kHz
- Gain-Bandwidth Product: 3.3MHz
- Slew Rate: 2V/ $\mu s$
- $-40^{\circ}C$  to  $+125^{\circ}C$  Operating Temperature Range
- Available in Green SOIC-8, MSOP-8, TDFN-2x2-8AL, TDFN-3x3-8BL and WLCSP-1.57x1.57-8B Packages

### APPLICATIONS

High Impedance Sensor  
Photodiode Amplifier  
High End, Professional Audio  
DAC Output Amplifier  
Medical

**PACKAGE/ORDERING INFORMATION**

MODEL	PACKAGE DESCRIPTION	SPECIFIED TEMPERATURE RANGE	ORDERING NUMBER	PACKAGE MARKING	PACKING OPTION
SGM8278-2	SOIC-8	-40°C to +125°C	SGM8278-2XS8G/TR	SGM 82782XS8 XXXXX	Tape and Reel, 4000
	MSOP-8	-40°C to +125°C	SGM8278-2XMS8G/TR	SGM82782 XMS8 XXXXX	Tape and Reel, 4000
	TDFN-2x2-8AL	-40°C to +125°C	SGM8278-2XTDE8G/TR	R41 XXXX	Tape and Reel, 3000
	TDFN-3x3-8BL	-40°C to +125°C	SGM8278-2XTDD8G/TR	SGM R42DD XXXXX	Tape and Reel, 4000
	WLCSP-1.57x1.57-8B	-40°C to +125°C	SGM8278-2XG/TR	XXXX R40	Tape and Reel, 3000

**MARKING INFORMATION**

NOTE: XXXX = Date Code and Trace Code. XXXXX = Date Code, Trace Code and Vendor Code.

**SOIC-8/MSOP-8**

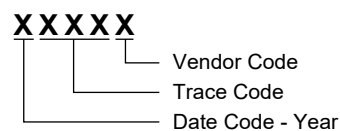

**TDFN-2x2-8AL**

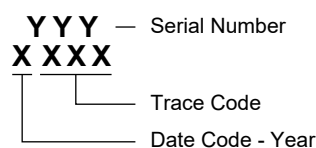

**TDFN-3x3-8BL**

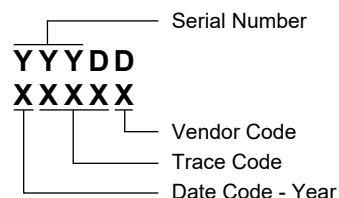

**WLCSP-1.57x1.57-8B**

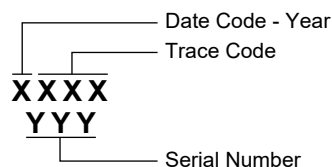

Green (RoHS & HSF): SG Micro Corp defines "Green" to mean Pb-Free (RoHS compatible) and free of halogen substances. If you have additional comments or questions, please contact your SGMICRO representative directly.

**ABSOLUTE MAXIMUM RATINGS**

Supply Voltage, +Vs to -Vs.....	40V
Input/Output Voltage Range.....	(-Vs) - 0.3V to (+Vs) + 0.3V
Junction Temperature .....	+150°C
Storage Temperature Range.....	-65°C to +150°C
Lead Temperature (Soldering, 10s) .....	+260°C
ESD Susceptibility	
HBM.....	4000V
CDM .....	1000V

**RECOMMENDED OPERATING CONDITIONS**

Operating Temperature Range .....	-40°C to +125°C
-----------------------------------	-----------------

NOTE: 1. It is recommended that CMOS device adopts the proper power supply sequence. Always sort the Vs first, followed by the inputs and outputs.

**OVERSTRESS CAUTION**

Stresses beyond those listed in Absolute Maximum Ratings may cause permanent damage to the device. Exposure to absolute maximum rating conditions for extended periods may affect reliability. Functional operation of the device at any conditions beyond those indicated in the Recommended Operating Conditions section is not implied.

**ESD SENSITIVITY CAUTION**

This integrated circuit can be damaged if ESD protections are not considered carefully. SGMICRO recommends that all integrated circuits be handled with appropriate precautions. Failure to observe proper handling and installation procedures can cause damage. ESD damage can range from subtle performance degradation to complete device failure. Precision integrated circuits may be more susceptible to damage because even small parametric changes could cause the device not to meet the published specifications.

**DISCLAIMER**

SG Micro Corp reserves the right to make any change in circuit design, or specifications without prior notice.

**PIN CONFIGURATIONS**

(TOP VIEW)

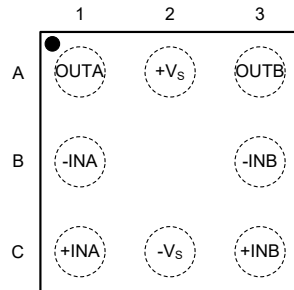

**WLCSP-1.57x1.57-8B**

(TOP VIEW)

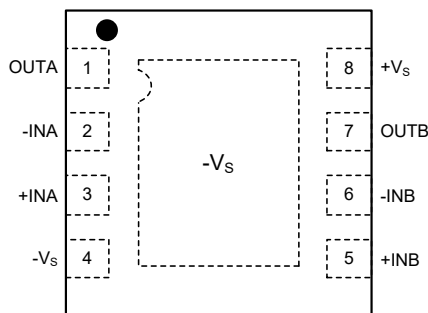

**TDFN-2x2-8AL/TDFN-3x3-8BL**

(TOP VIEW)

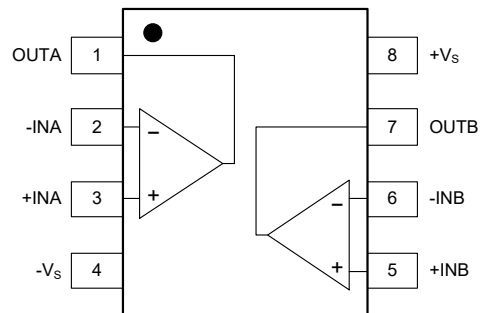

**SOIC-8/MSOP-8**

NOTE: For TDFN-2x2-8AL and TDFN-3x3-8BL packages, exposed pad can be connected to -Vs or left floating.

**ELECTRICAL CHARACTERISTICS**(At  $T_A = +25^\circ\text{C}$ ,  $V_S = \pm 1.5\text{V}$  to  $\pm 18\text{V}$  and  $R_L = 2\text{k}\Omega$  connected to  $0\text{V}$ , Full =  $-40^\circ\text{C}$  to  $+125^\circ\text{C}$ , unless otherwise noted.)

PARAMETER	SYMBOL	CONDITIONS	TEMP	MIN	TYP	MAX	UNITS
<b>Input Characteristics</b>							
Input Offset Voltage	$V_{OS}$	$V_{CM} = 0\text{V}$	+25°C		0.4	2	mV
			Full			2.5	
Input Offset Voltage Drift	$\Delta V_{OS}/\Delta T$		Full		2		$\mu\text{V}/^\circ\text{C}$
Input Bias Current	$I_B$	$V_{CM} = 0\text{V}$	+25°C		$\pm 10$	800	pA
Input Offset Current	$I_{OS}$	$V_{CM} = 0\text{V}$	+25°C		$\pm 10$	800	pA
Maximum Differential Input Voltage	$ V_{ID} $		Full			$(+V_S) - (-V_S)$	V
Maximum Input Difference Bias Current	$ I_{ID} $	$V_S = \pm 18\text{V}$ , $V_{ID} = \pm 18\text{V}$	+25°C		2	3.5	$\mu\text{A}$
			Full			5	
Input Common Mode Voltage Range	$V_{CM}$		Full	$(-V_S) - 0.1$		$(+V_S) + 0.1$	V
Common Mode Rejection Ratio	CMRR	$V_S = \pm 18\text{V}$ , $(-V_S) - 0.1\text{V} < V_{CM} < (+V_S) - 2\text{V}$	+25°C	98	115		dB
			Full	95			
		$V_S = \pm 18\text{V}$ , $(-V_S) - 0.1\text{V} < V_{CM} < (+V_S) + 0.1\text{V}$	+25°C	83	100		
			Full	80			
Open-Loop Voltage Gain	$A_{OL}$	$(-V_S) + 0.2\text{V} < V_{OUT} < (+V_S) - 0.2\text{V}$ , $R_L = 10\text{k}\Omega$	+25°C	103	125		dB
			Full	100			
		$(-V_S) + 0.5\text{V} < V_{OUT} < (+V_S) - 0.5\text{V}$ , $R_L = 2\text{k}\Omega$	+25°C	100	120		
			Full	97			
<b>Output Characteristics</b>							
Output Voltage Swing from Rail	$V_{OUT}$	$V_S = \pm 18\text{V}$ , $R_L = 10\text{k}\Omega$	+25°C		25	40	mV
			Full			60	
		$V_S = \pm 18\text{V}$ , $R_L = 2\text{k}\Omega$	+25°C		120	150	
			Full			230	
		$V_S = \pm 3\text{V}$ , $R_L = 600\Omega$	+25°C		65	85	
			Full			125	
		$V_S = \pm 3\text{V}$ , $R_L = 32\Omega$	+25°C		920	1200	
			Full			1500	
Output Short-Circuit Current	$I_{SC}$	$V_S = \pm 3\text{V}$	+25°C	55	95		mA
<b>Power Supply</b>							
Operating Voltage Range	$V_S$		Full	3		36	V
Quiescent Current	$I_Q$	$I_{OUT} = 0\text{A}$	+25°C		2.4	3.2	mA
			Full			4	
Power Supply Rejection Ratio	PSRR	$V_S = 5\text{V}$ to $36\text{V}$	+25°C	100	124		dB
			Full	97			

**ELECTRICAL CHARACTERISTICS (continued)**(At  $T_A = +25^\circ\text{C}$ ,  $V_S = \pm 1.5\text{V}$  to  $\pm 18\text{V}$  and  $R_L = 2\text{k}\Omega$  connected to  $0\text{V}$ , Full =  $-40^\circ\text{C}$  to  $+125^\circ\text{C}$ , unless otherwise noted.)

PARAMETER	SYMBOL	CONDITIONS	TEMP	MIN	TYP	MAX	UNITS
<b>Dynamic Performance</b>							
Gain-Bandwidth Product	GBP	$C_L = 50\text{pF}$	$+25^\circ\text{C}$		3.3		MHz
Phase Margin	$\phi_o$	$C_L = 50\text{pF}$	$+25^\circ\text{C}$		70		°
Slew Rate	SR	$G = +1$	$+25^\circ\text{C}$		2		$\text{V}/\mu\text{s}$
Overload Recovery Time	ORT	$V_{IN} \times G > V_S$	$+25^\circ\text{C}$		0.4		$\mu\text{s}$
Total Harmonic Distortion + Noise	THD+N	$V_S = \pm 2.5\text{V}$ to $\pm 18\text{V}$ , $V_{OUT} = 2V_{P-P}$ , $f = 1\text{kHz}$ , $G = +1$ , $R_L = 600\Omega$ , $BW = 20\text{Hz}$ to $80\text{kHz}$	$+25^\circ\text{C}$		0.001		%
		$V_S = \pm 2.5\text{V}$ to $\pm 18\text{V}$ , $V_{OUT} = 2V_{P-P}$ , $f = 1\text{kHz}$ , $G = +1$ , $R_L = 2\text{k}\Omega$ , $BW = 20\text{Hz}$ to $80\text{kHz}$	$+25^\circ\text{C}$		0.0005		
<b>Noise</b>							
Input Voltage Noise		$f = 0.1\text{Hz}$ to $10\text{Hz}$	$+25^\circ\text{C}$		2		$\mu\text{V}_{P-P}$
Input Voltage Noise Density	$e_n$	$f = 10\text{Hz}$	$+25^\circ\text{C}$		60		$\text{nV}/\sqrt{\text{Hz}}$
		$f = 1\text{kHz}$	$+25^\circ\text{C}$		15		
Input Current Noise Density	$i_n$	$f = 1\text{kHz}$	$+25^\circ\text{C}$		300		$\text{fA}/\sqrt{\text{Hz}}$

TYPICAL PERFORMANCE CHARACTERISTICS

At  $T_A = +25^\circ\text{C}$ ,  $V_S = \pm 18\text{V}$ , unless otherwise noted.

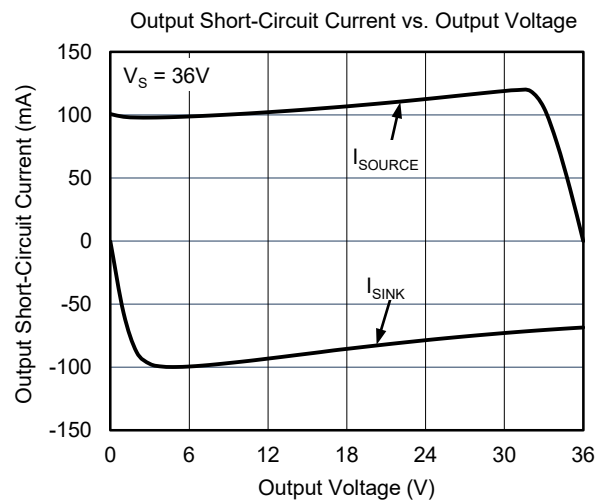
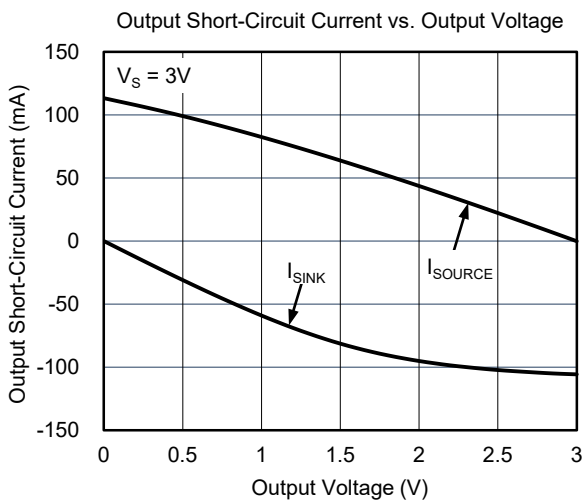
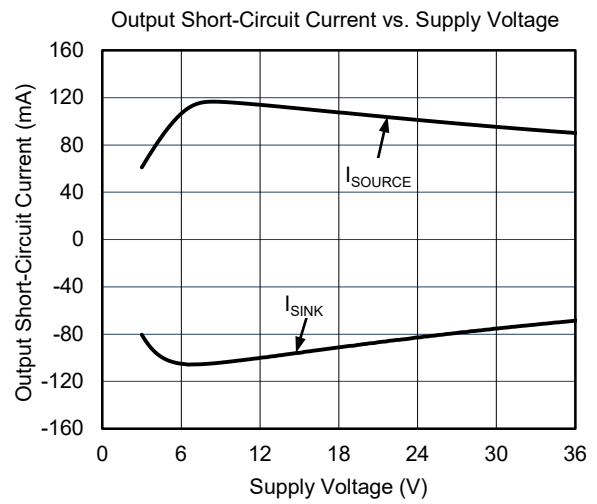
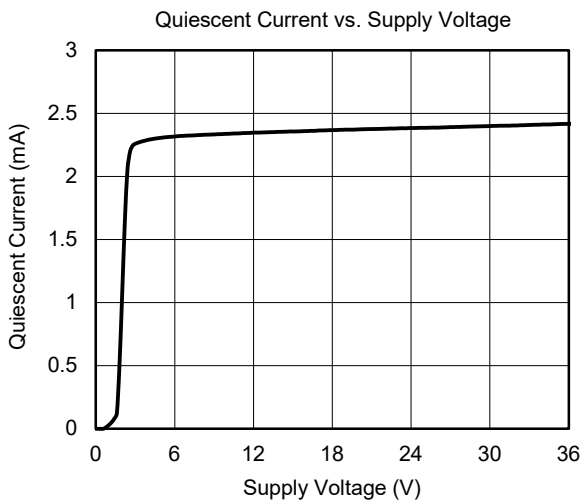
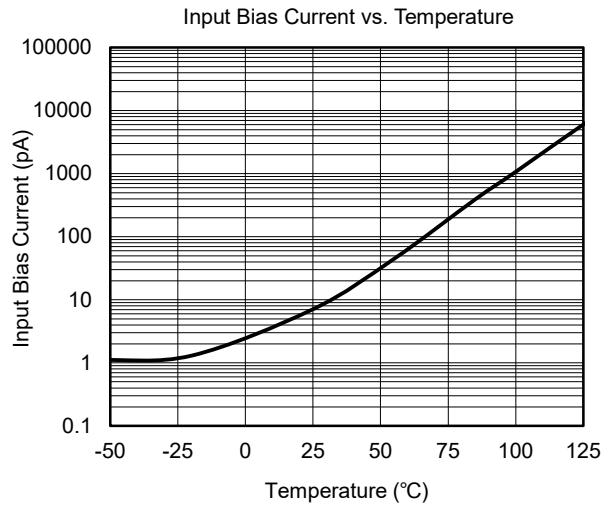
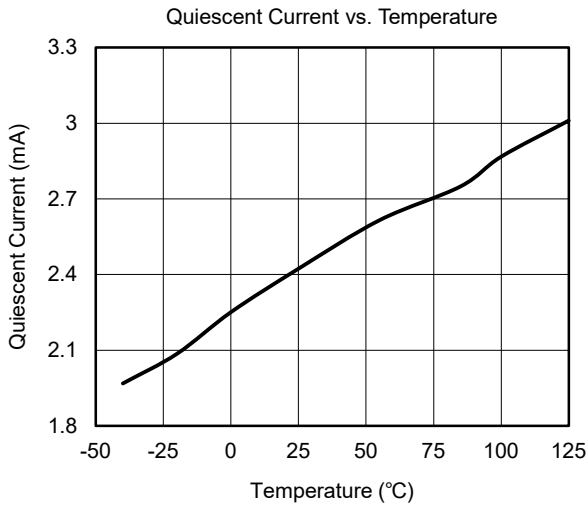

**TYPICAL PERFORMANCE CHARACTERISTICS (continued)**

At  $T_A = +25^\circ\text{C}$ ,  $V_S = \pm 18\text{V}$ , unless otherwise noted.

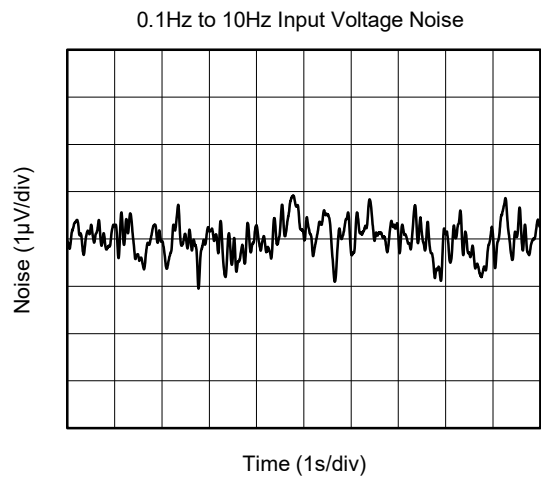
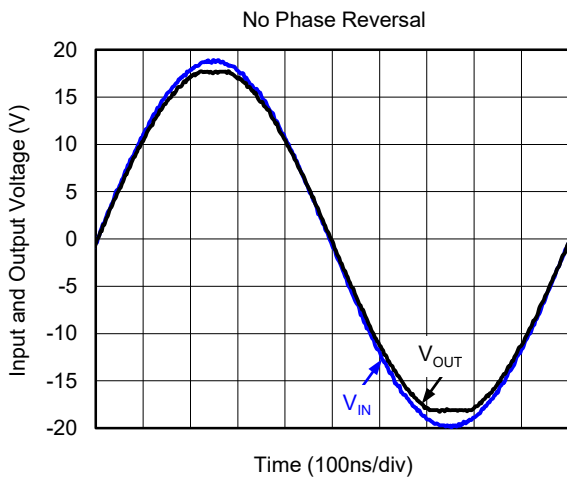
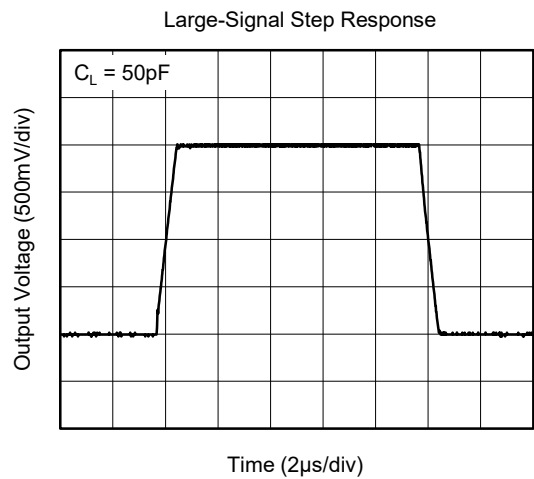
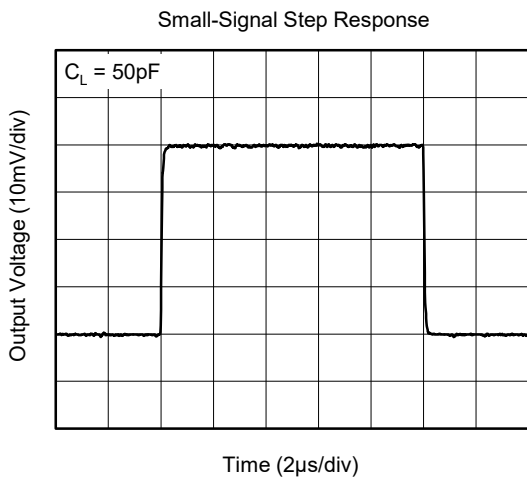
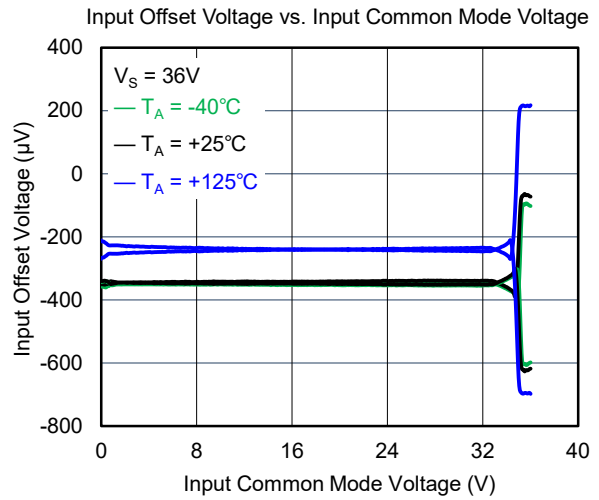
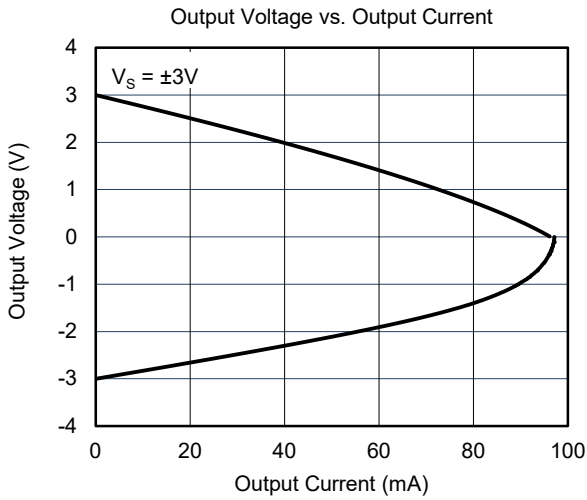

**TYPICAL PERFORMANCE CHARACTERISTICS (continued)**

At  $T_A = +25^\circ\text{C}$ ,  $V_S = \pm 18\text{V}$ , unless otherwise noted.

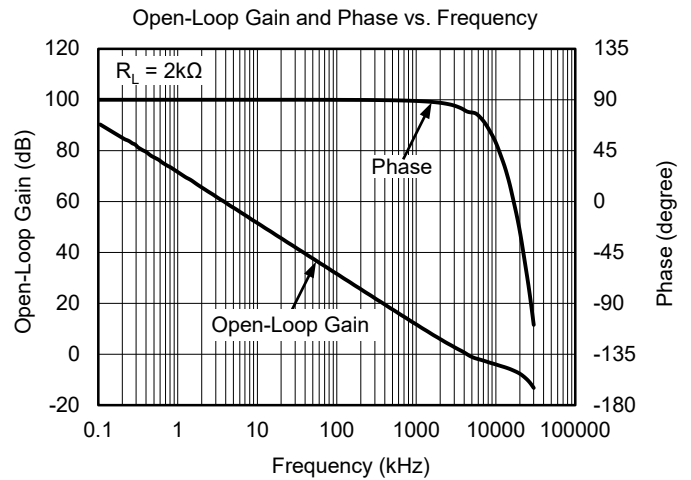
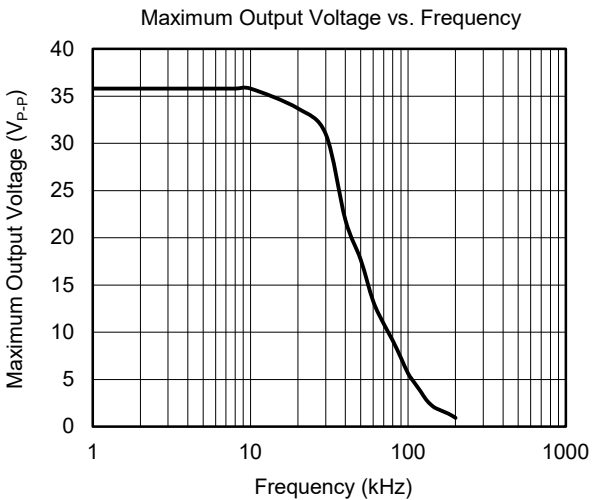
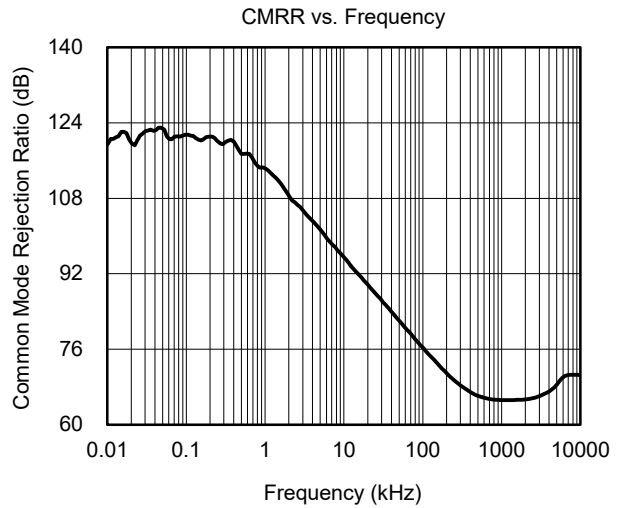
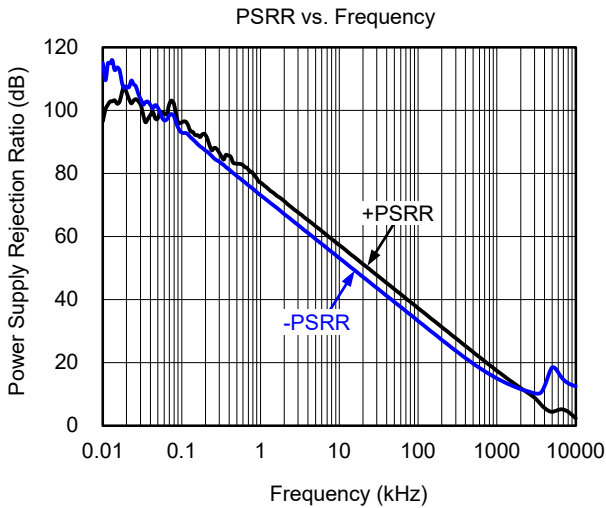
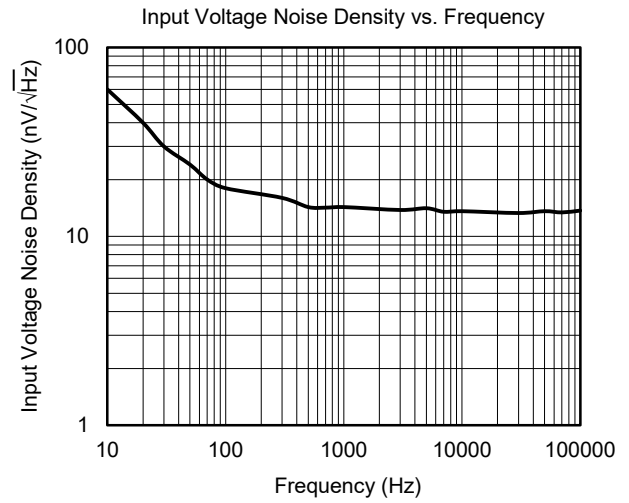
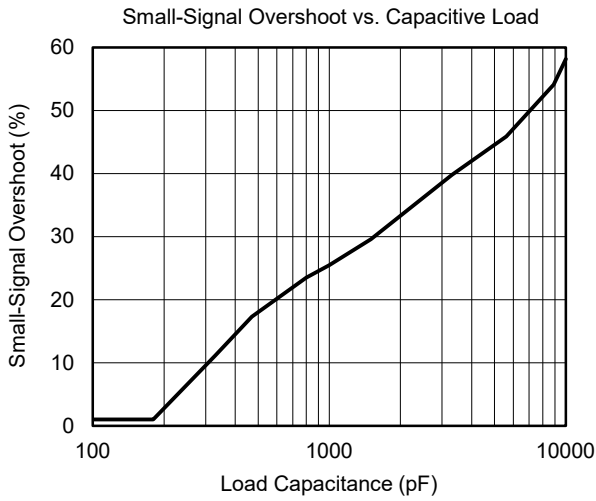



**TYPICAL PERFORMANCE CHARACTERISTICS (continued)**

At  $T_A = +25^\circ\text{C}$ ,  $V_S = \pm 18\text{V}$ , unless otherwise noted.

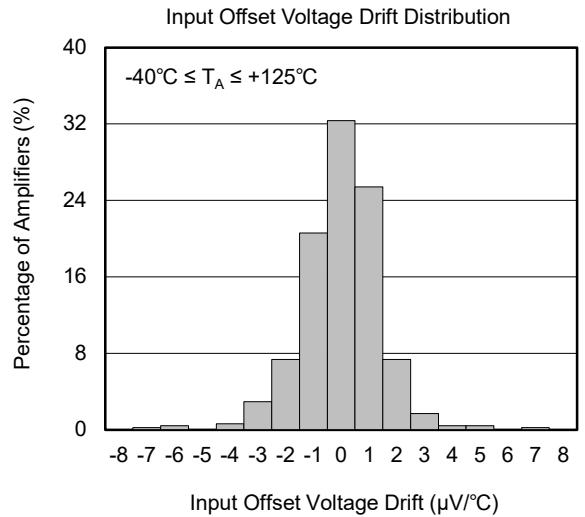
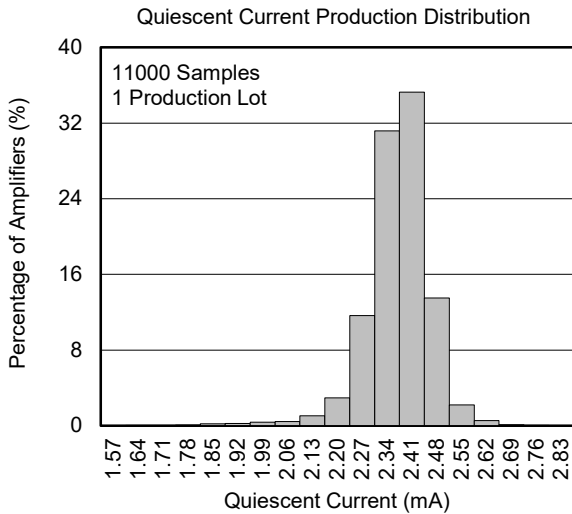
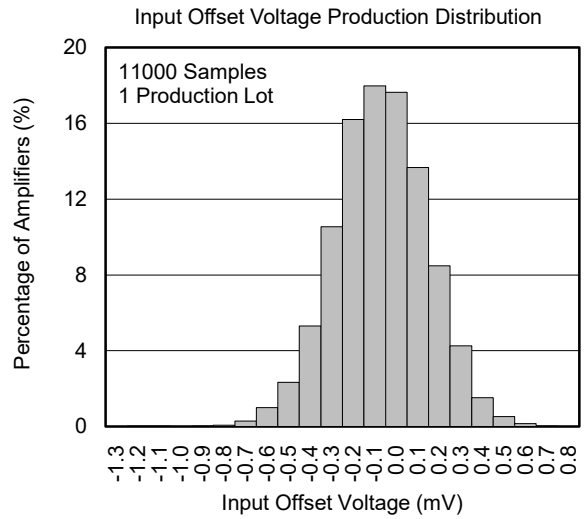
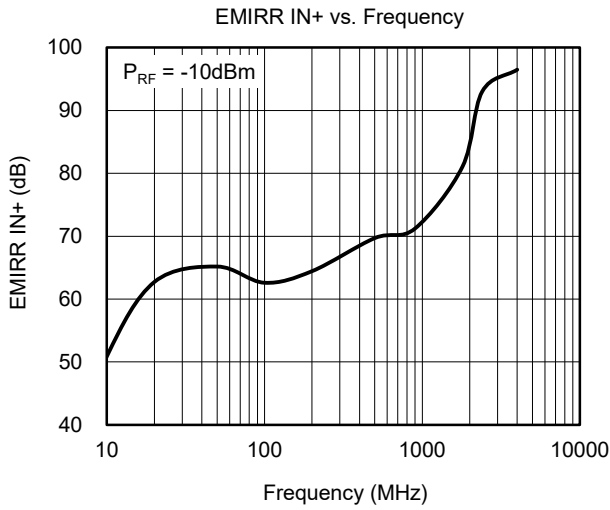

**REVISION HISTORY**

NOTE: Page numbers for previous revisions may differ from page numbers in the current version.

<b>JULY 2022 – REV.A to REV.A.1</b>	<b>Page</b>
Updated Typical Performance Characteristics section .....	8

---

<b>Changes from Original (DECEMBER 2020) to REV.A</b>	<b>Page</b>
Changed from product preview to production data.....	All

---

PACKAGE OUTLINE DIMENSIONS

WLCSP-1.57x1.57-8B

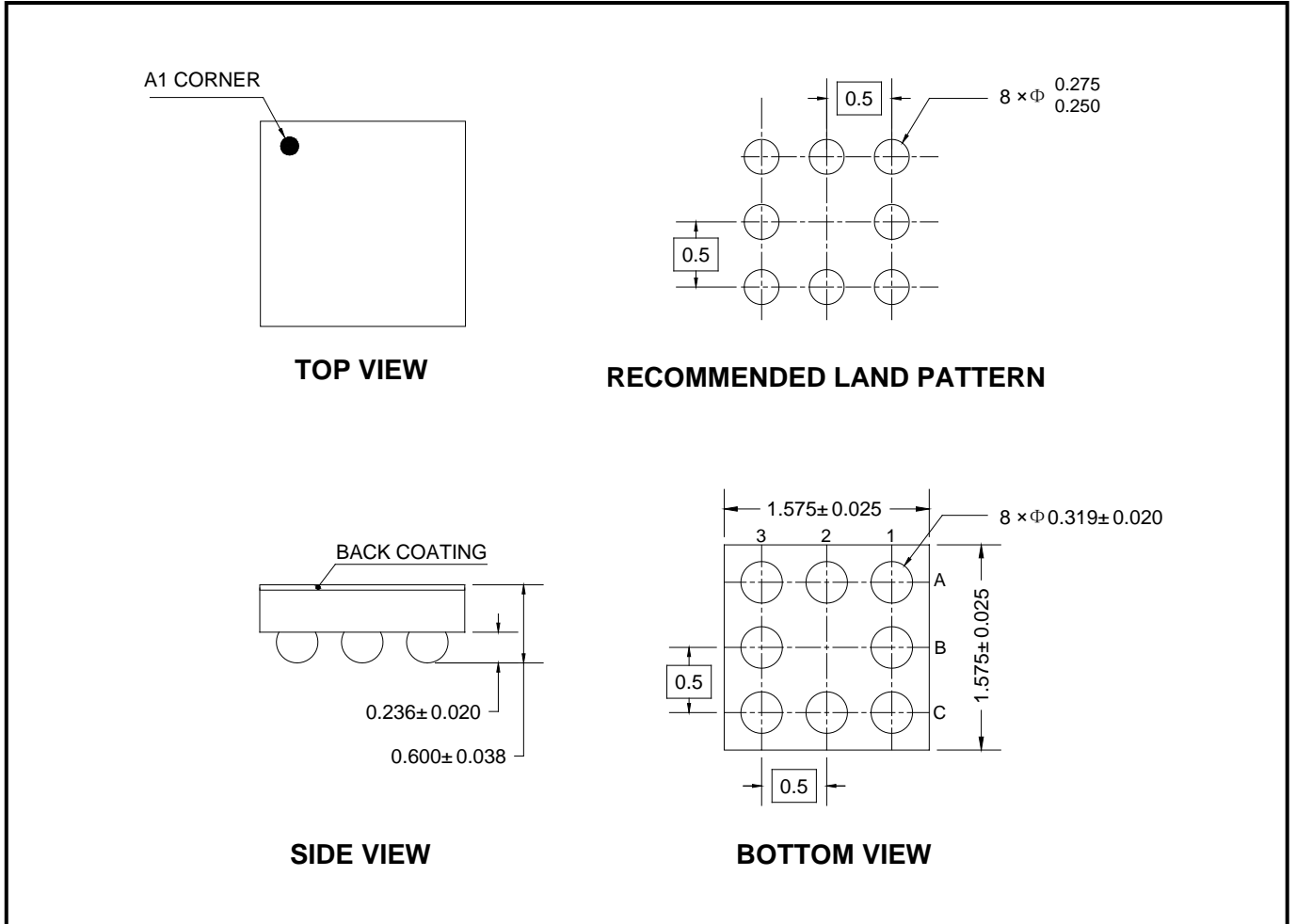

NOTES:

1. All linear dimensions are in millimeters.
2. This drawing is subject to change without notice.

PACKAGE OUTLINE DIMENSIONS

TDFN-2x2-8AL

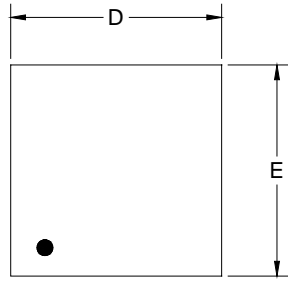

TOP VIEW

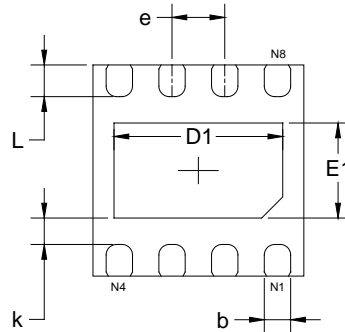

BOTTOM VIEW

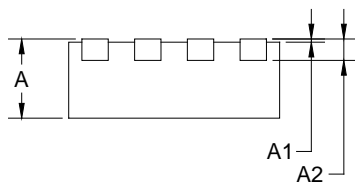

SIDE VIEW

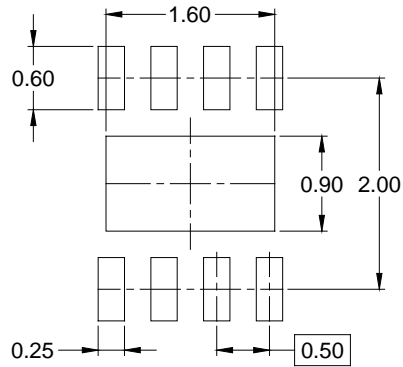

RECOMMENDED LAND PATTERN (Unit: mm)

Symbol	Dimensions In Millimeters		
	MIN	MOD	MAX
A	0.70	0.75	0.80
A1	0.00	0.02	0.05
A2	0.203 REF		
b	0.20	0.25	0.30
D	2 BSC		
D1	1.50	1.60	1.70
E	2 BSC		
E1	0.80	0.90	1.00
k	0.15	0.25	0.35
e	0.5 BSC		
L	0.25	0.30	0.35

PACKAGE OUTLINE DIMENSIONS

TDFN-3x3-8BL

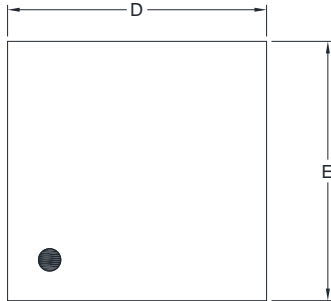

TOP VIEW

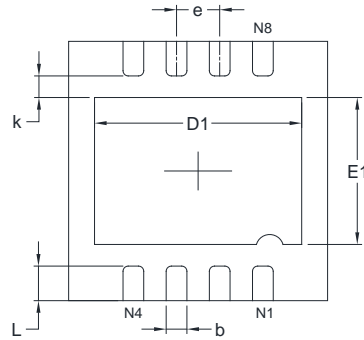

BOTTOM VIEW

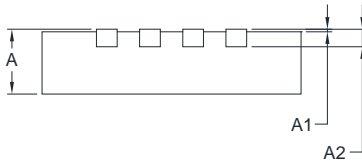

SIDE VIEW

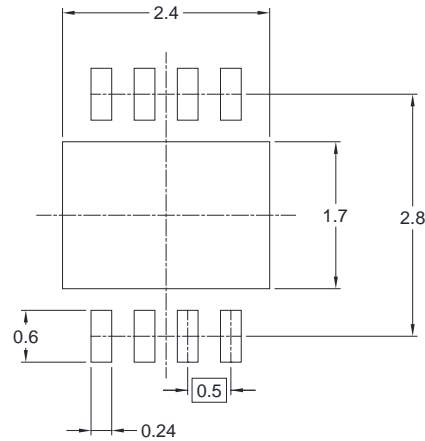

RECOMMENDED LAND PATTERN (Unit: mm)

Symbol	Dimensions In Millimeters		Dimensions In Inches	
	MIN	MAX	MIN	MAX
A	0.700	0.800	0.028	0.031
A1	0.000	0.050	0.000	0.002
A2	0.203 REF		0.008 REF	
D	2.900	3.100	0.114	0.122
D1	2.300	2.500	0.091	0.098
E	2.900	3.100	0.114	0.122
E1	1.600	1.800	0.063	0.071
k	0.200 MIN		0.008 MIN	
b	0.180	0.300	0.007	0.012
e	0.500 TYP		0.020 TYP	
L	0.300	0.500	0.012	0.020

NOTE: This drawing is subject to change without notice.

PACKAGE OUTLINE DIMENSIONS

SOIC-8

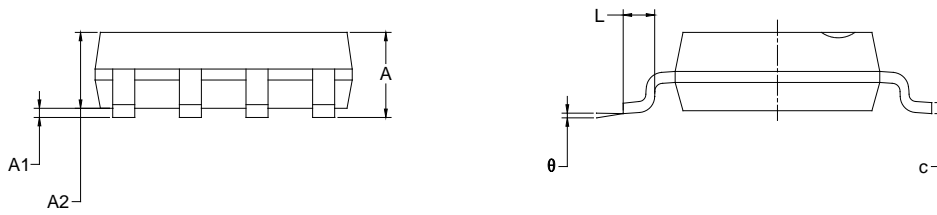
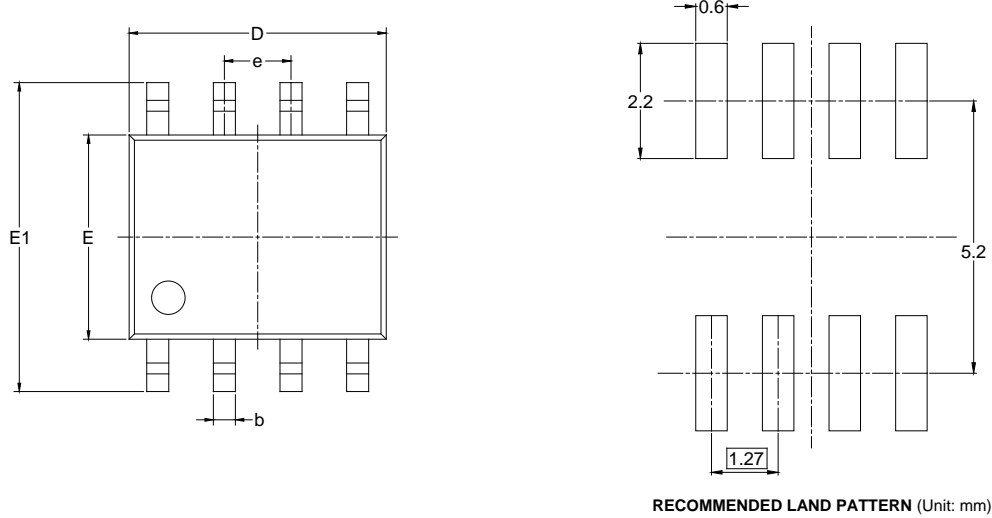

Symbol	Dimensions In Millimeters		Dimensions In Inches	
	MIN	MAX	MIN	MAX
A	1.350	1.750	0.053	0.069
A1	0.100	0.250	0.004	0.010
A2	1.350	1.550	0.053	0.061
b	0.330	0.510	0.013	0.020
c	0.170	0.250	0.006	0.010
D	4.700	5.100	0.185	0.200
E	3.800	4.000	0.150	0.157
E1	5.800	6.200	0.228	0.244
e	1.27 BSC		0.050 BSC	
L	0.400	1.270	0.016	0.050
θ	0°	8°	0°	8°

NOTES:  
 1. Body dimensions do not include mode flash or protrusion.  
 2. This drawing is subject to change without notice.

PACKAGE OUTLINE DIMENSIONS

MSOP-8

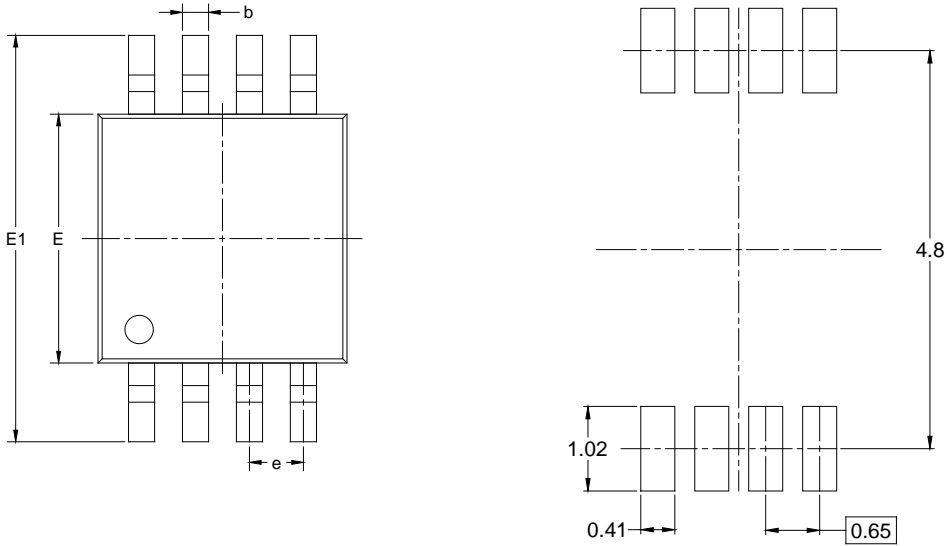

RECOMMENDED LAND PATTERN (Unit: mm)

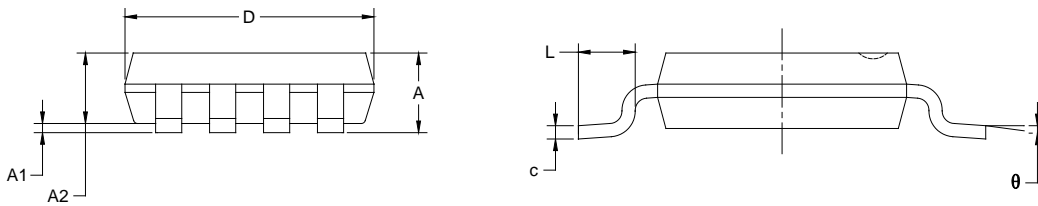

Symbol	Dimensions In Millimeters		Dimensions In Inches	
	MIN	MAX	MIN	MAX
A	0.820	1.100	0.032	0.043
A1	0.020	0.150	0.001	0.006
A2	0.750	0.950	0.030	0.037
b	0.250	0.380	0.010	0.015
c	0.090	0.230	0.004	0.009
D	2.900	3.100	0.114	0.122
E	2.900	3.100	0.114	0.122
E1	4.750	5.050	0.187	0.199
e	0.650 BSC		0.026 BSC	
L	0.400	0.800	0.016	0.031
θ	0°	6°	0°	6°

NOTES:

1. Body dimensions do not include mode flash or protrusion.
2. This drawing is subject to change without notice.

# PACKAGE INFORMATION

## TAPE AND REEL INFORMATION

### REEL DIMENSIONS



### TAPE DIMENSIONS



NOTE: The picture is only for reference. Please make the object as the standard.

### KEY PARAMETER LIST OF TAPE AND REEL

Package Type	Reel Diameter	Reel Width W1 (mm)	A0 (mm)	B0 (mm)	K0 (mm)	P0 (mm)	P1 (mm)	P2 (mm)	W (mm)	Pin1 Quadrant
WLCSP-1.57×1.57-8B	7"	9.2	1.73	1.73	0.72	4.0	4.0	2.0	8.0	Q1
TDFN-2×2-8AL	7"	9.5	2.30	2.30	1.10	4.0	4.0	2.0	8.0	Q1
TDFN-3×3-8BL	13"	12.4	3.35	3.35	1.13	4.0	8.0	2.0	12.0	Q1
SOIC-8	13"	12.4	6.40	5.40	2.10	4.0	8.0	2.0	12.0	Q1
MSOP-8	13"	12.4	5.20	3.30	1.50	4.0	8.0	2.0	12.0	Q1

D20001



# PACKAGE INFORMATION

## CARTON BOX DIMENSIONS



NOTE: The picture is only for reference. Please make the object as the standard.

## KEY PARAMETER LIST OF CARTON BOX

Reel Type	Length (mm)	Width (mm)	Height (mm)	Pizza/Carton
7" (Option)	368	227	224	8
7"	442	410	224	18
13"	386	280	370	5

DD0002