

## N-Channel Enhancement Mode Power MOSFET

### Description

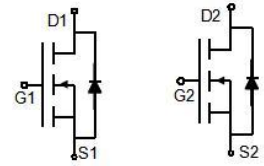
The G33N03D52 uses advanced trench technology to provide excellent  $R_{DS(ON)}$ , low gate charge. It can be used in a wide variety of applications.

### General Features

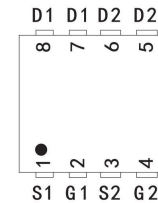
- $V_{DS}$  30V
- $I_D$  (at  $V_{GS} = 10V$ ) 33A
- $R_{DS(ON)}$  (at  $V_{GS} = 10V$ ) < 13m $\Omega$
- $R_{DS(ON)}$  (at  $V_{GS} = 4.5V$ ) < 30m $\Omega$
- 100% Avalanche Tested
- RoHS Compliant

### Application

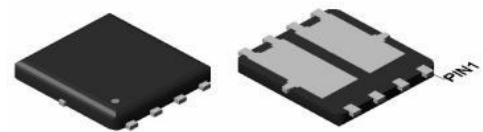
- Power switch
- DC/DC converters



Schematic diagram



pin assignment



DFN5X6 Dual

### Ordering Information

Device	Package	Marking	Packaging
G33N03D52	DFN5*6-8L Dual	G33N03	5000psc/Reel

### Absolute Maximum Ratings $T_C = 25^\circ\text{C}$ , unless otherwise noted

Parameter	Symbol	Value	Unit
Drain-Source Voltage	$V_{DS}$	30	V
Continuous Drain Current	$I_D$	33	A
Pulsed Drain Current (note1)	$I_{DM}$	132	A
Gate-Source Voltage	$V_{GS}$	$\pm 20$	V
Power Dissipation	$P_D$	29	W
Single pulse avalanche energy (note2)	$E_{AS}$	42	mJ
Operating Junction and Storage Temperature Range	$T_J, T_{stg}$	-55 To 150	$^\circ\text{C}$

### Thermal Resistance

Parameter	Symbol	Value	Unit
Thermal Resistance, Junction-to-Ambient	$R_{thJA}$	60	$^\circ\text{C/W}$
Maximum Junction-to-Case	$R_{thJC}$	4.2	$^\circ\text{C/W}$

Specifications $T_J = 25^\circ\text{C}$ , unless otherwise noted						
Parameter	Symbol	Test Conditions	Value			Unit
			Min.	Typ.	Max.	
<b>Static Parameters</b>						
Drain-Source Breakdown Voltage	$V_{(BR)DSS}$	$V_{GS} = 0V, I_D = 250\mu A$	30	--	--	V
Zero Gate Voltage Drain Current	$I_{DSS}$	$V_{DS} = 30V, V_{GS} = 0V$	--	--	1	$\mu A$
Gate-Source Leakage	$I_{GSS}$	$V_{GS} = \pm 20V$	--	--	$\pm 100$	nA
Gate-Source Threshold Voltage	$V_{GS(th)}$	$V_{DS} = V_{GS}, I_D = 250\mu A$	1	1.85	3	V
Drain-Source On-Resistance	$R_{DS(on)}$	$V_{GS} = 10V, I_D = 16A$	--	8	13	m $\Omega$
		$V_{GS} = 4.5V, I_D = 14A$	--	26	30	
Forward Transconductance	$g_{FS}$	$V_{GS} = 5V, I_D = 16A$	--	23	--	S
<b>Dynamic Parameters</b>						
Input Capacitance	$C_{iss}$	$V_{GS} = 0V,$ $V_{DS} = 15V,$ $f = 1.0MHz$	--	782	--	pF
Output Capacitance	$C_{oss}$		--	154	--	
Reverse Transfer Capacitance	$C_{rss}$		--	144	--	
Total Gate Charge	$Q_g$	$V_{DD} = 15V,$ $I_D = 10A,$ $V_{GS} = 10V$	--	17.5	--	nC
Gate-Source Charge	$Q_{gs}$		--	3	--	
Gate-Drain Charge	$Q_{gd}$		--	7.1	--	
Turn-on Delay Time	$t_{d(on)}$	$V_{DD} = 15V,$ $I_D = 10A,$ $R_G = 3\Omega$	--	5	--	ns
Turn-on Rise Time	$t_r$		--	12	--	
Turn-off Delay Time	$t_{d(off)}$		--	19	--	
Turn-off Fall Time	$t_f$		--	6	--	
<b>Drain-Source Body Diode Characteristics</b>						
Continuous Body Diode Current	$I_S$	$T_C = 25^\circ\text{C}$	--	--	33	A
Body Diode Voltage	$V_{SD}$	$T_J = 25^\circ\text{C}, I_{SD} = 16A, V_{GS} = 0V$	--	--	1.2	V
Reverse Recovery Charge	$Q_{rr}$	$I_F = 20A, V_{GS} = 0V$ $di/dt=500A/us$	--	23	--	nC
Reverse Recovery Time	$T_{rr}$		--	11	--	ns

### Notes

1. Repetitive Rating: Pulse width limited by maximum junction temperature
2. EAS condition :  $T_J=25^\circ\text{C}$  ,  $V_{DD}=30V, V_{GS}=10V, L=0.5mH, R_g=25\Omega$
3. Identical low side and high side switch with identical  $R_G$

### Gate Charge Test Circuit



### Switch Time Test Circuit

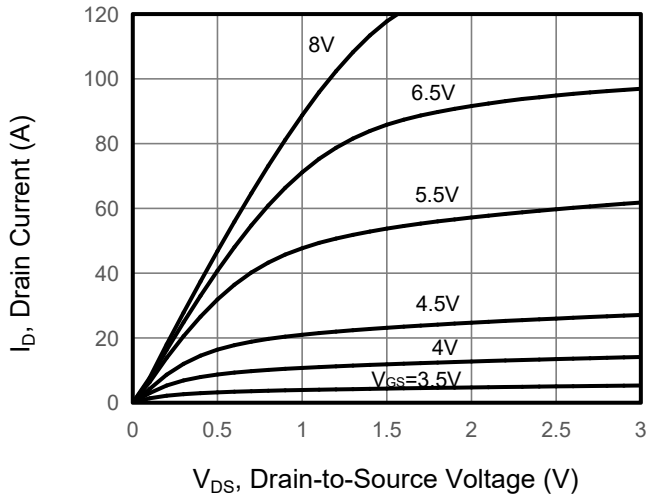


### EAS Test Circuit

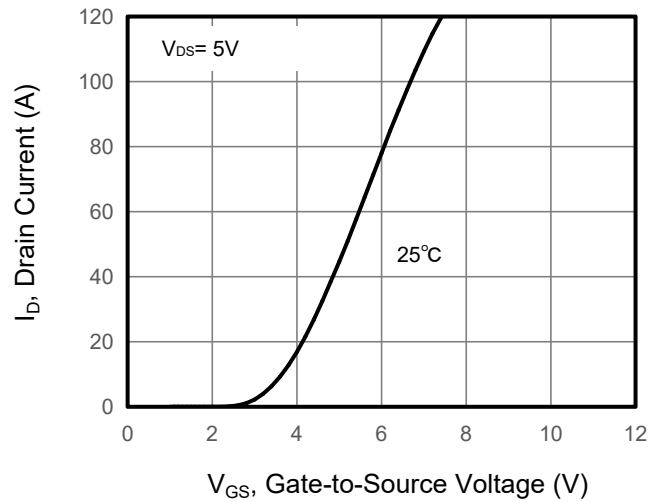


Typical Characteristics  $T_J = 25^\circ\text{C}$ , unless otherwise noted

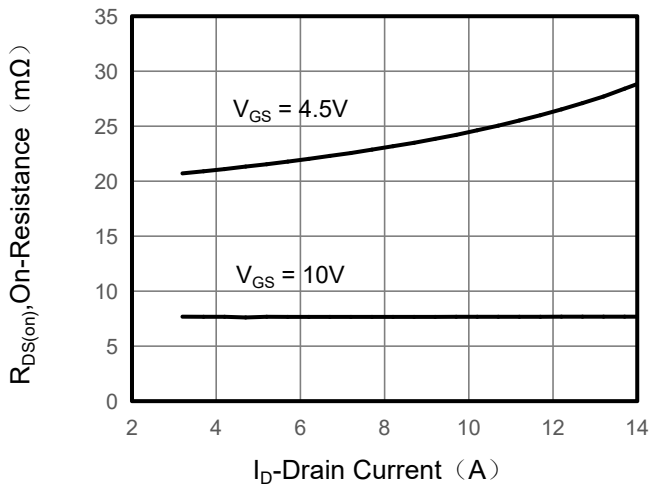
**Figure 1. Output Characteristics**



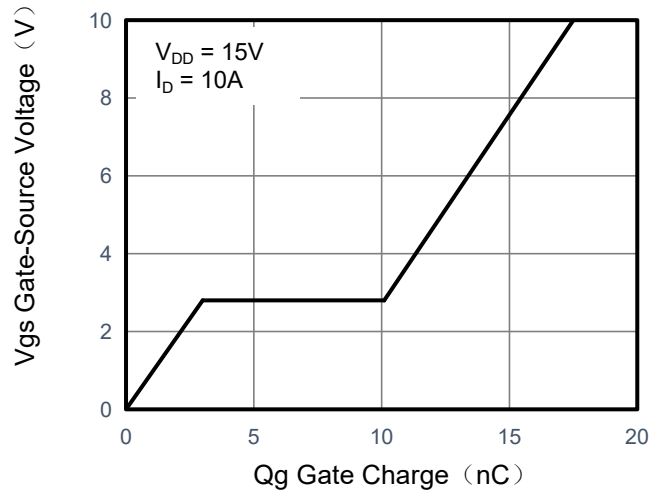
**Figure 2. Transfer Characteristics**



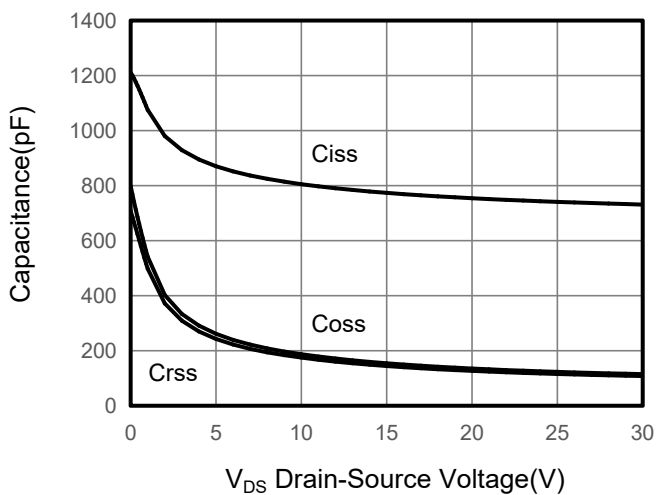
**Figure 3. Drain Source On Resistance**



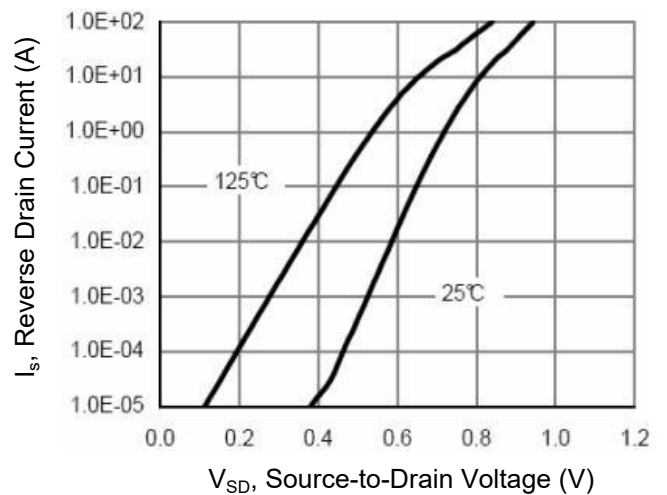
**Figure 4. Gate Charge**



**Figure 5. Capacitance**

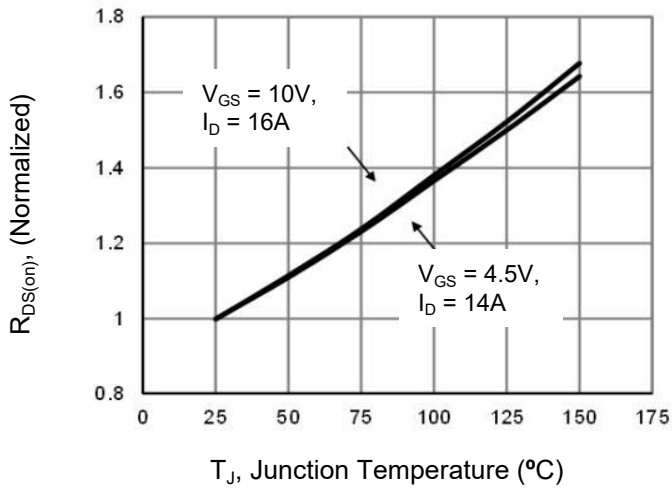


**Figure 6. Source-Drain Diode Forward**

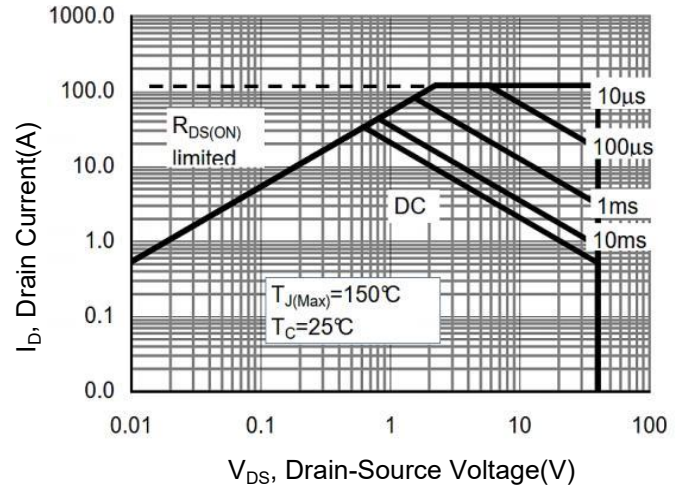


## Typical Characteristics $T_J = 25^\circ\text{C}$ , unless otherwise noted

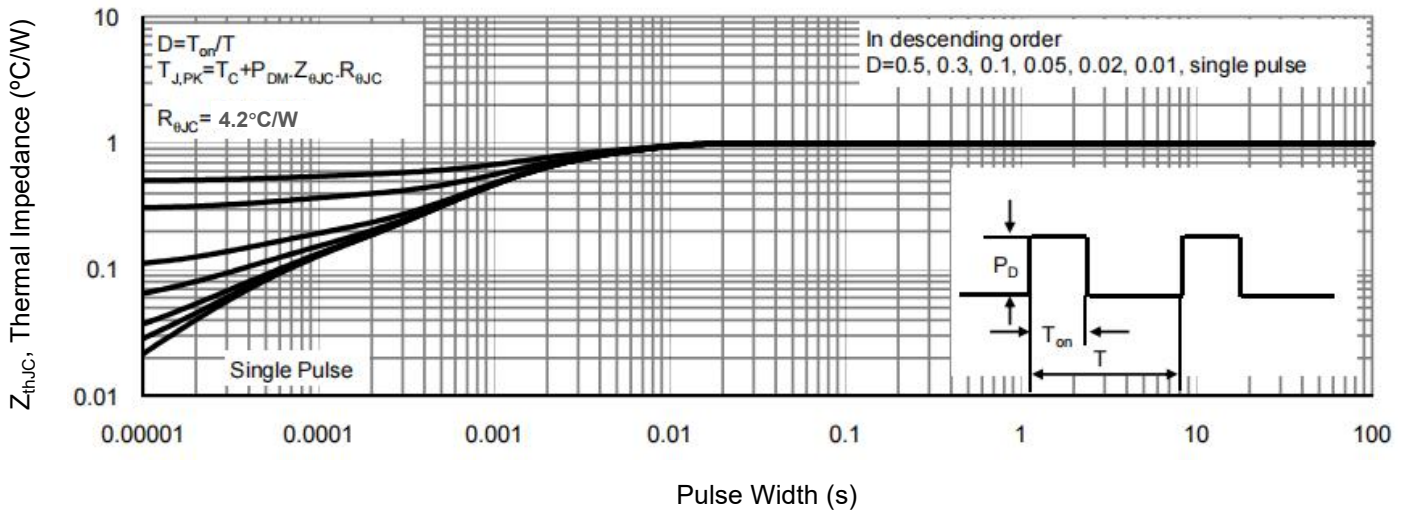
**Figure 7. Drain-Source On-Resistance**



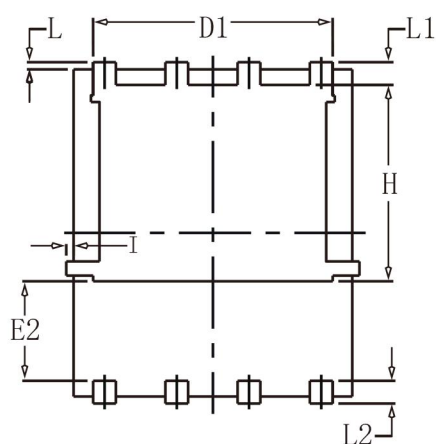
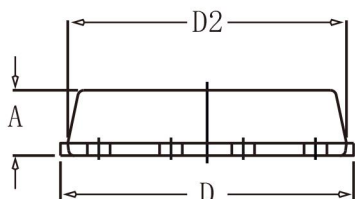
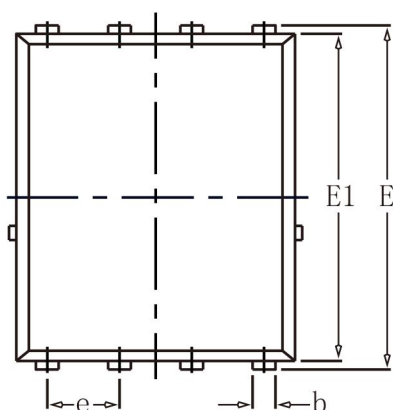
**Figure 8. Safe Operation Area**



**Figure 9. Normalized Maximum Transient Thermal Impedance**



## DFN5X6-8L Package Information



SYMBOL	COMMON			
	MM		INCH	
	MIN	MAX	MIN	MAX
A	1.03	1.17	0.0406	0.0461
b	0.34	0.48	0.0134	0.0189
c	0.824	0.970	0.0324	0.0382
D	4.80	5.40	0.1890	0.2126
D1	4.11	4.31	0.1618	0.1697
D2	4.80	5.00	0.1890	0.1969
E	5.59	6.15	0.2343	0.2421
E1	5.65	5.85	0.2224	0.2303
E2	1.60	-	0.0630	-
e	1.27 BSC		0.05 BSC	
L	0.05	0.25	0.0020	0.0098
L1	0.38	0.50	0.0150	0.0197
L2	0.38	0.50	0.0150	0.0197
H	3.30	3.50	0.1299	0.1378
I	-	0.18	-	0.0070