

CUSTOMER

REV.	ECN NO.	DESCRIPTION	DATE	DESIGN

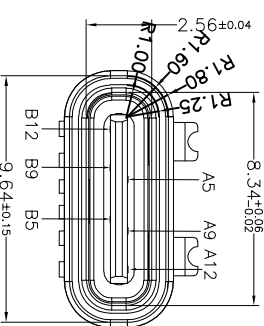
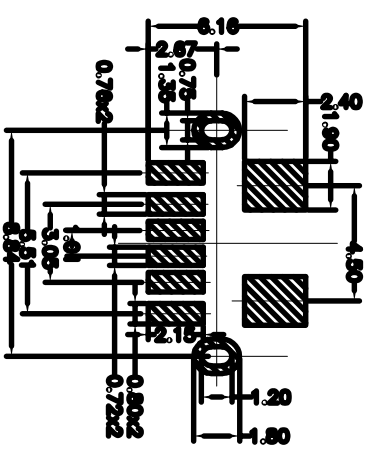
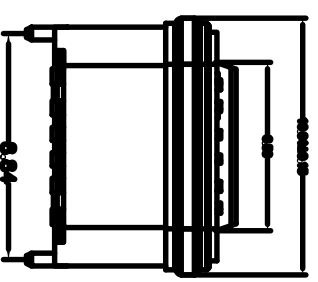
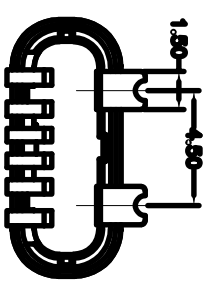
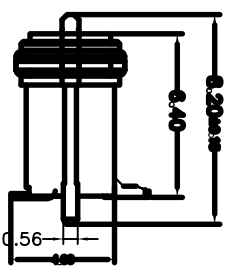
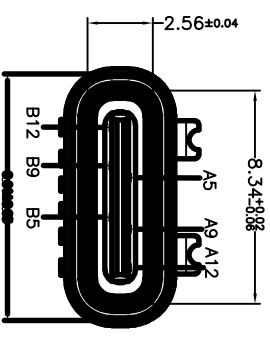
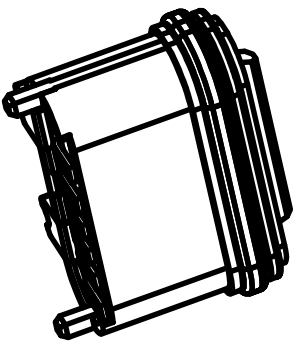
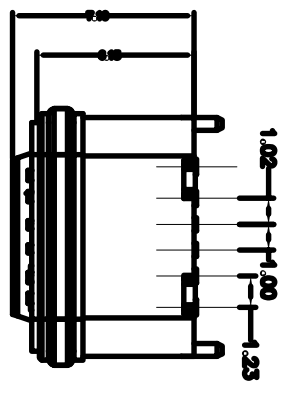

R角

- Note:
- Material:
 - Housing: PA9T
 - Contact: C5191, t=0.20mm
 - Shell: Kirsite
 - ELECTRICAL:
 - CURRENT RATING: VBUS AND GND CONTACTS RATED AT 1.25A PARALLELED FOR A TOTAL OF 5A;
 - INITIAL CONTACT RESISTANCE: 40 MEGOHMS
 - DIELECTRIC WITHSTANDING VOLTAGE: 100V AC MIN;
 - MECHANICAL CHARACTERISTICS:
 - MATING FORCE: 5~20N
 - UNMATING FORCE: 8~20N (INITIAL), 6~20N (AFTER 10000 CYCLES)
 - FREQUENCY: 200±50 CYCLES / HOUR, 10000 CYCLES
 - OPERATING TEMPERATURE: -40°~80°.

TABLE B

A5	CC1	B12	GND
A9	VBUS	B9	VBUS
A12	GND	B5	CC2
PIN	SIGNAL NAME	PIN	SIGNAL NAME

TOLERANCE	NAME (INTENDED USE)	Guangdong FYUOU Precision Electronic Technology Co., Ltd.
X.X ±0.30 X.X' ±10° .XX ±0.20 X.X' ± 8° .XXX ±0.10 .XX' ± 5°	CUSTOMER DRAWING PART NO. FY23-018TC64F64-01	
UNITS: mm	DESIGN: ZXM	DRAWG NO. FY23-018TC61F64-02
MATERILA: ---	CHED: ---	SCALE SHEET 1/1
FINISH: ---	APPD: ---	REV. A