



# Iono RP D16 User Guide

*August 2022*

*Revision 001*

***IRMD10X*** Iono RP D16

***IRMD10R*** Iono RP D16 with RTC

***IRMD10S*** Iono RP D16 with RTC and Secure Element

a general-purpose, industrial input/output module based on the Raspberry Pi RP2040



Safety information	4
Qualified personnel	4
Hazard levels	4
Safety instructions	5
General safety instructions	5
Battery	5
Introduction	7
Features	8
Usage and connections	9
Device identification	9
Power supply	10
Control logic section	10
Digital input/output section	10
Auxiliary voltage outputs	10
D1-D16 digital inputs	10
D1-D16 digital outputs	11
D1-D16 connection and protection	11
Overvoltage protection	12
Thermal protection	12
DT1-DT4 5 V-level input/output lines	12
RS-485 serial port	12
EERAM	14
ON LED control	14
Mapping	15
Hardware Installation	16
Opening the case	16
Closing the case	16
Software development	18
Programming interfaces	18
USB interface	18
SWD interface	19
Optional components	20
Real Time Clock module	20
Replacing the RTC backup battery	20
ATECC608 secure element	21
Earthquake sensor module	22

Block diagram	23
Board layout	24
Technical specifications	25
Dimensions	28
Disposal	29
Installation and use restrictions	29
Standards and regulations	29
Safety instructions	29
Set-up	29
Conformity Information	30
EU	30
USA	30
CANADA	30
RCM AUSTRALIA / NEW ZEALAND	31

**Iono RP D16 must be operated with the plastic case installed.**

**Follow all applicable electrical safety standards, guidelines, specifications and regulations for installation, wiring and operations of Iono RP D16 modules.**

**Carefully and fully read this Iono RP D16 user guide before installation.**

Iono RP D16 is not authorised for use in safety-critical applications where a failure of the product would reasonably be expected to cause personal injury or death. Safety-critical applications include, without limitation, life support devices and systems, equipment or systems for the operation of nuclear facilities and weapons systems. Iono RP D16 is neither designed nor intended for use in military or aerospace applications or environments and for automotive applications. Customer acknowledges and agrees that any such use of Iono RP D16 is solely at Customer's risk, and that Customer is solely responsible for compliance with all legal and regulatory requirements in connection with such use.

Sfera Labs S.r.l. may make changes to specifications and product descriptions at any time, without notice. The product information on the web site or materials is subject to change without notice.

Please download and read the Sfera Labs Terms and Conditions document available at:

**<http://www.sferalabs.cc>**

Iono and Sfera Labs are trademarks of Sfera Labs S.r.l. Other brands and names may be claimed as the property of others.

Copyright © 2022 Sfera Labs S.r.l. All rights reserved.

## Safety information

Carefully and fully read this user guide before installation and retain it for future reference.

### Qualified personnel

The product described in this manual must be operated only by personnel qualified for the specific task and installation environment, in accordance with all relevant documentation and safety instructions. A qualified person should be capable of fully identifying all installation and operation risks and avoid potential hazards when working with this product.

### Hazard levels

This manual contains information you must observe to ensure your personal safety and prevent damage to property. Safety information in this manual are highlighted by the safety symbols below, graded according to the degree of danger.



Indicates a hazardous situation which, if not avoided, **will** result in death or serious personal injury.



Indicates a hazardous situation which, if not avoided, **may** result in death or serious personal injury.



Indicates a hazardous situation which, if not avoided, can result in minor or moderate personal injury.



Indicates a situation which, if not avoided, can result in damage of property.

## Safety instructions

---

### General safety instructions

Protect the unit against moisture, dirt and any kind of damage during transport, storage and operation. Do not operate the unit outside the specified technical data.

Never open the housing. If not otherwise specified, install in closed housing (e.g. distribution cabinet). Earth the unit at the terminals provided, if existing, for this purpose. Do not obstruct cooling of the unit. Keep out of the reach of children.



Life threatening voltages are present within and around an open control cabinet.

When installing this product in a control cabinet or any other areas where dangerous voltages are present, always switch off the power supply to the cabinet or equipment.



Risk of fire if not installed and operated properly.

Follow all applicable electrical safety standards, guidelines, specifications and regulations for installation, wiring and operations of this product.

Ensure that the product is properly installed and ventilated to prevent overheat.



The connection of expansion devices to this product may damage the product and other connected systems, and may violate safety rules and regulations regarding radio interference and electromagnetic compatibility.

Use only appropriate tools when installing this product. Using excessive force with tools may damage the product, alter its characteristics or degrade its safety.

---

### Battery

This product optionally uses a small lithium non-rechargeable battery to power its internal real time clock (RTC).



Improper handling of lithium batteries can result in an explosion of the batteries and/or release of harmful substances.

Worn-out or defective batteries can compromise the function of this product.

Replace the RTC lithium battery before it is completely discharged. The lithium battery must be replaced only with an identical battery. See the "Replacing the RTC backup battery" section for instructions.

Do not throw lithium batteries into fire, do not solder on the cell body, do not recharge, do not open, do not short-circuit, do not reverse polarity, do not heat above 100°C and protect from direct sunlight, moisture and condensation.

Dispose of used batteries according to local regulations and the battery manufacturer's instructions.

## Introduction

Iono RP D16 combines the ease of use of the Raspberry Pi RP2040 microcontroller with multiple digital input and output interfaces; the result is a rugged, safe, reliable and easy to connect module, suited for installation both in industrial and residential environments.

Iono RP D16 has an embedded RP2040, with a dual-core Arm Cortex M0+ processor, clocked up to 133 MHz, 264 KB of SRAM, and a large 16 MB on-board Flash memory.

A hidden USB 1.1 port with device and host support is primarily used to easily flash the microcontroller, but could also be used to connect external USB devices.





## Features

The Iono RP D16 key features are:

- ✓ 12÷28 Vdc power supply, with surge and reverse polarity protection, and 1.1 A resettable fuse
- ✓ RP2040, dual-core Arm Cortex M0+ processor, clocked up to 133 MHz, 264 KB of SRAM
- ✓ 16 MB on-board Flash memory
- ✓ 16 isolated digital input/output lines, with dedicated power supply inputs
- ✓ current-sinking 24 V IEC 61131-2 compliant industrial digital inputs with diagnostics, based on MAX22190
- ✓ 640 mA, 24 V outputs that can be configured as high-side switches or push-pull drivers for high-speed switching, based on MAX14912/MAX14913
- ✓ four 5 V level digital input/output lines
- ✓ standard RS-485 interface to the RP2040 UART serial pins, with electrostatic discharge protection
- ✓ 1-Wire, I2C and Wiegand support
- ✓ auxiliary 5 V and supply voltage outputs, with overcurrent protection
- ✓ optional real time clock with on-board Lithium / Manganese Dioxide back-up battery
- ✓ optional secure element chip
- ✓ optional earthquake sensor module
- ✓ removable terminal blocks for easier installation
- ✓ inputs protected against electrostatic discharges and temporary over voltages
- ✓ compact, standard modular housing 3 units size, suitable for mounting on Omega rail.

# Usage and connections

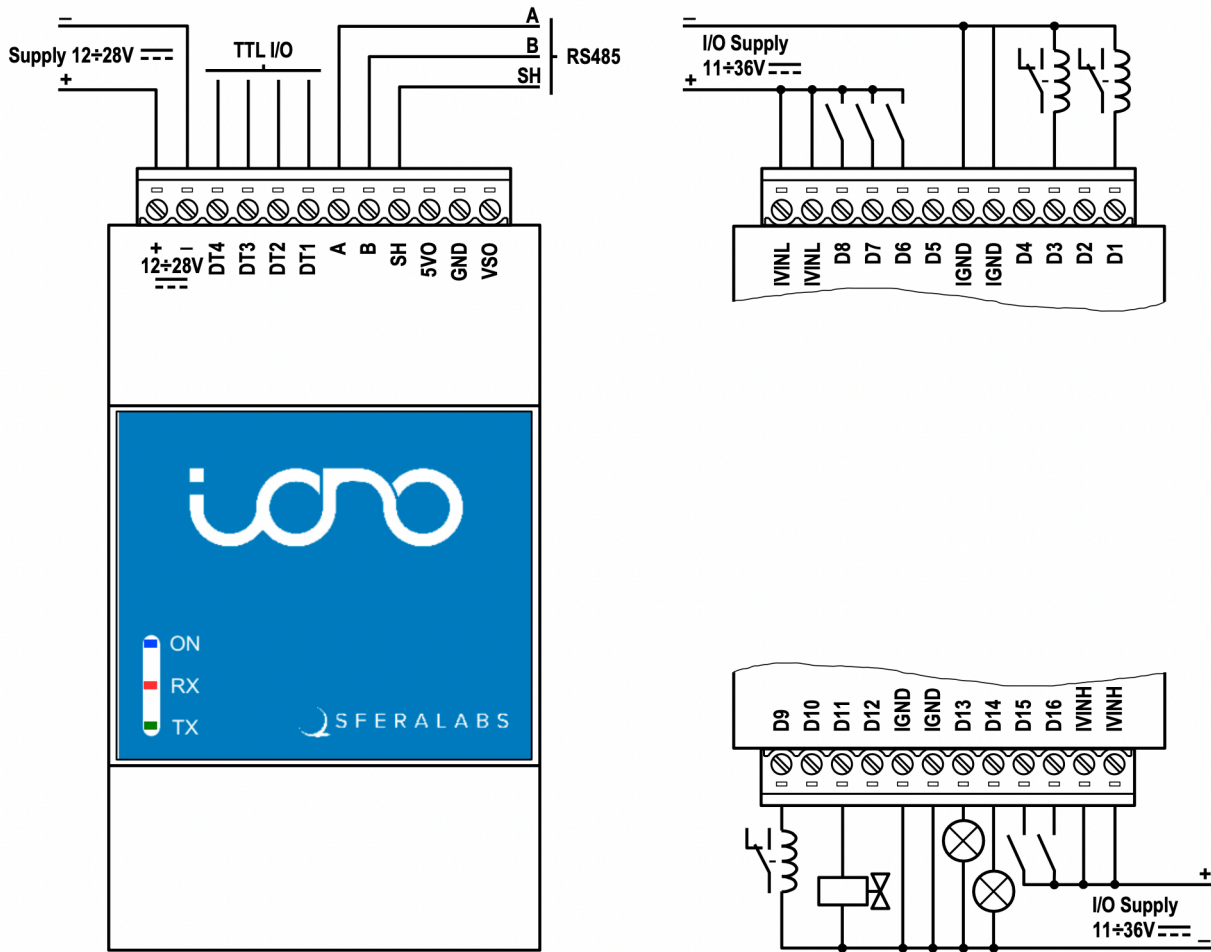

CONNECTION EXAMPLE

## Device identification

The device can be identified with the information provided in the rating and identification plate, permanently attached to the side of the case.

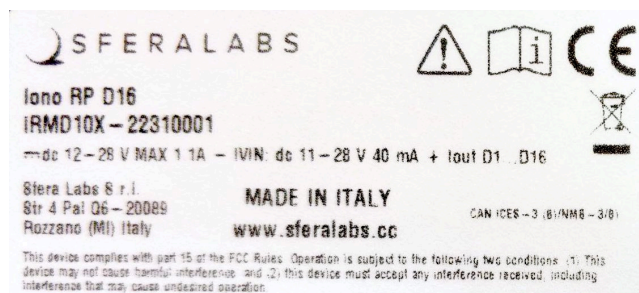

EXAMPLE RATING AND IDENTIFICATION PLATE

## Power supply

Iono RP D16 can be powered with DC voltage only.

The device is split in two distinct and galvanically isolated sections, the control logic section and the digital input/output section.

### Control logic section

✓ DC: nominal voltage between 12 V and 28 V (min=10 V, max=30 V)

Respect the correct polarity shown in the schematic diagram (+ -). The power supply circuit implements reverse polarity protection using an auto resetting fuse and surge protection up to  $\pm 500 \text{ V}/2 \text{ Ohm } 1.2/50 \mu\text{s}$ .

### Digital input/output section

✓ DC: nominal voltage between 12 V and 28 V (min=10.5 V, max=36 V)

Respect the correct polarity: ground connected to IGND and positive voltage level to IVINL and IVINH. IVINL and IVINH can be supplied with different voltages.

IVINL powers the D1-D8 outputs, while IVINH separately powers the D9-D16 outputs.

IVINL and IVINH are not required for the inputs. If all D1-D8 lines are used as inputs, IVINL should be left unconnected. If all D9-D16 lines are used as inputs, IVINH should be left unconnected. The IGND connection is always required.

IGND, IVINL and IVINH are each available at two adjacent terminals on the terminal blocks. Always connect both terminals to the appropriate lines, as a significant amount of current may flow through these lines.

## Auxiliary voltage outputs

Iono RP D16 has an auxiliary 5 Vdc voltage output pin on the terminal block, labeled 5VOUT, to supply power to external 1-Wire devices or other low-power loads. This output implements an overcurrent protection circuit, with a typical maximum current of 420 mA. When 5VOUT is turned off because the overcurrent threshold has been exceeded, it is automatically turned back on when the load is removed.

Another auxiliary voltage output pin, labeled VSOUT, is also available on the terminal block. It is intended as the voltage source for small loads and dry contacts connected to the digital inputs. Its typical output voltage is  $V_S - 1 \text{ V}$ . Do not exceed the maximum rated current of 300 mA on this output.

## D1-D16 digital inputs

Iono RP D16 has two banks of current-sinking 24 V IEC 61131-2 compliant industrial digital inputs, based on two MAX22190 integrated circuits, connected to D1-D8 and D9-D16 terminals. Wire-break detection can be enabled individually on each input line.

The MAX22190 chips are controlled by the RP2040 via its SPI serial bus, chip-select lines, a latch line and a shared fault line.

All these control lines are galvanically isolated from the RP2040 logic section.

The latch line can be used to synchronize input data on both input banks.

The fault line is asserted (low) on various, configurable, fault conditions, including wire-break.

Refer to the MAX22190 data sheet for the complete specifications of the digital input lines.

## D1-D16 digital outputs

Iono RP D16 has two banks of 24 V outputs that can be configured as high-side switches or push-pull drivers for high-speed switching, based on two MAX14912/MAX14913 integrated circuits, connected to D1-D8 and D9-D16 terminals. Open-load detection in high-side mode detects open-wire conditions in the switch on/off states. Internal active clamps accelerate the shutdown of inductive loads in high-side mode. Other diagnostic and protection features include per chip and individual line thermal shutdown, overvoltage detection, and overcurrent detection.

The MAX14912/MAX14913 chips are controlled by the RP2040 via its SPI serial bus, chip-select lines, a watchdog enable line, and a shared fault line.

The watchdog enable line is pulled high (enabled), so that the MAX14912/MAX14913 watchdog logic is normally active. It can be driven low by the RP2040 to disable the watchdog if needed.

The fault line is asserted (low) on various fault conditions, including open-load.

All these control lines are galvanically isolated from the RP2040 logic section.

Refer to the MAX14912/MAX14913 data sheet for the complete specifications of the digital output lines.

## D1-D16 connection and protection

Besides the diagnostics and protection mechanisms implemented in the MAX14912/MAX14913 output drivers, additional protections should be implemented in the RP2040 to prevent overheating and permanent damage in specific conditions. Two of these conditions are discussed below.

These protection mechanisms are implemented in the standard libraries provided by Sfera Labs (see the "Software development" chapter). If the user's firmware does not use the provided libraries, it shall implement the protection logic described below.

Some use cases may require the implementation of different or additional protection logic, or be subject to other electrical and operational limitations.



If the IVINL lines are connected, never apply voltages higher than IVINL to the D1-D8 lines.

If the IVINH lines are connected, never apply voltages higher than IVINH to the D9-D16 lines.

---

## Overvoltage protection

When an output line of the MAX14912/MAX14913 driver is configured as high-side and set to OFF, if a voltage is applied to that line that is higher than  $0.3V + IVIN^1$ , a considerable amount of current will flow from the output to the MAX14912/MAX14913 VDD, and to the IVIN terminal, if IVIN is connected.

The MAX14912/MAX14913 will heat quickly, possibly leading to permanent damage of the chip itself and the device in general.

Setting the output to ON will still allow current to flow from out to IVIN, but the internal resistance becomes very low, reducing the IC's dissipation and temperature.

When this condition occurs, the per-channel overvoltage bits in register 7 are set to 1. This can be used to protect the IC. The firmware should check register 7 and, if an OV flag is set, the corresponding output should be driven to ON and remain in this state for at least 10 seconds.

This logic should also be implemented when a D1-D16 line is configured as an input (and thus the output is set to high-side/OFF and never driven ON).

Connecting only passive loads to the D1-D16 lines, when used as outputs, or dry contacts powered by IVIN, when used as inputs, electrically prevents the occurrence of an overvoltage condition.

---

## Thermal protection

If the MAX14912/MAX14913 per-channel thermal shutdown occurs, with THSD bits in register 5 being set to 1 for the affected outputs, the firmware should configure the output as high-side/OFF for at least 30 seconds, before returning to the original configuration.

## DT1-DT4 5 V-level input/output lines

Iono RP D16 features 4 general-purpose TTL-level (0-5 V) input/output lines, that can also be used as 1-Wire, I<sup>2</sup>C, or Wiegand interfaces.

## NOTICE

You should limit the voltage applied to the DT1-DT4 between +0 V and +5 V (TTL level). Exceeding this voltage range will result in damage to the RP2040 board and Iono RP D16.

## RS-485 serial port

Iono RP D16 uses the RP2040 UART0 TX/RX pins (GPIO16 and GPIO17 respectively) to implement a standard RS-485 serial port.

Simply connect the RS-485 A, B, and GND to the RS-485 pins of the terminal block.

The RS-485 port is protected from ESD and voltage surges, and supports half-duplex communication up to to 115200 bps.

---

<sup>1</sup> IVINL for D1-D8 and IVINH for D9-D16.

The RS-485 TX/RX switching is controlled by a digital output pin of the RP2040 (GPIO14). You should set GPIO14 low to enable transmission on the RS-485, and set it high to allow reception of incoming data.

If GPIO14 is left high, or not configured as output during transmission, the Iono RP D16 RS-485 driver will automatically drive the RS-485 lines in the dominant state, so that it is not strictly required to control GPIO14 in order to transmit data.

The RS-485 line has 620 Ohm pull-up and pull-down resistors on lines A and B. The biasing resistors ensure that, during idle periods the data lines are kept at a stable voltage level and prevent false triggering of receiver input. A 120 Ohm termination resistor between A and B can also be enabled.

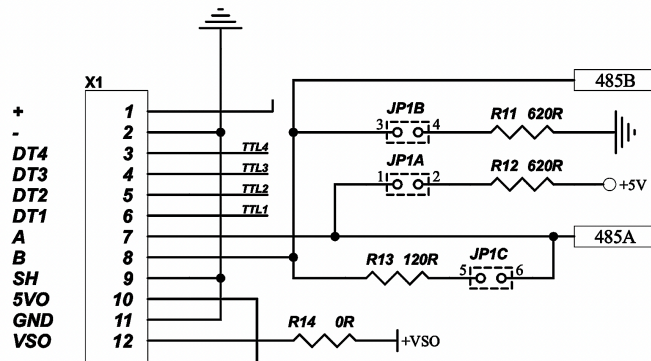

**RS-485 JUMPERS SCHEMATIC**

These resistors can be enabled installing jumpers on JP1 according to the following table.

A PULL-UP	B PULL-DOWN	TERMNATION
A	A	A
B	B	B
X	X	X



**RS-485 JUMPERS POSITION**

## EERAM

Iono RP D16 has a Microchip 47L16 16 Kbit SRAM with EEPROM Backup. This chip combines the persistent storage characteristics of a traditional EEPROM, without the limitations in terms of number of erase cycles. It is connected to the RP2040 I<sup>2</sup>C bus I2C0, GPIO0 (SDA) and GPIO1 (SCL), address: 0x50 for the SRAM and 0x18 for the control register.

## ON LED control

The ON LED is normally on when the Iono RP D16 is powered, but it is also possible to control it from the RP2040 using the SPI CS (chip select) lines, as shown in the circuit diagram below. To turn the LED on or off, first set the SPI CS OUT D1-D8 line low or high, then set both SPI CS IN D1-D8 and SPI CS IN D9-D16 low to latch the LED status. The LED will remain in its on or off state until SPI CS IN D1-D8 and SPI CS IN D9-D16 are again both set low to latch a new state.

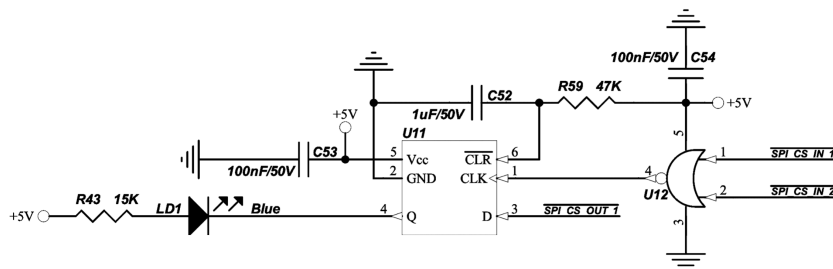

ON LED CONTROL LINES

## Mapping

The following table shows the mapping of the inputs and outputs of the Iono RP D16 module to the related pins of the RP2040 microcontroller.

Iono RP D16 inputs and outputs	RP2040 pins
DT1	38 (GPIO26)
DT2	39 (GPIO27)
DT3	40 (GPIO28)
DT4	41 (GPIO29)
SPI CLOCK	4 (GPIO2)
SPI MOSI	5 (GPIO3)
SPI MISO	6 (GPIO4)
SPI CS OUT D1-D8 (active low)	8 (GPIO6)
SPI CS OUT D9-D16 (active low)	7 (GPIO5)
SPI CS IN D1-D8 (active low)	11 (GPIO8)
SPI CS IN D9-D16 (active low)	9 (GPIO7)
IN LATCH D1-D16 (active low)	12 (GPIO9)
OUT WD ENABLE	29 (GPIO18)
IN FAULT D1-D16 (active low)	30 (GPIO19)
OUT FAULT D1-D16 (active low)	31 (GPIO20)
RS-485 RX	28 (GPIO17)
RS-485 TX	27 (GPIO16)
RS-485 TX-ENABLE (active low)	17 (GPIO14)
I2C SDA for EERAM and optionals	2 (GPIO0)
I2C SCL for EERAM and optionals	3 (GPIO1)



## Hardware Installation

For the initial set-up, the plastic DIN rail case must be removed to access the circuit boards and internal connectors, including the USB connector and the BOOTSEL button.

The case also needs to be opened to change the factory configuration of the internal jumpers for the RS-485 termination resistors.

### NOTICE

Before opening the Iono RP D16 case, disconnect all power sources and any connection to external devices.

---

#### Opening the case

Follow these steps, in the exact order, to open the case:

1. Remove the green pluggable terminal blocks
2. Remove the black plastic DIN rail hook
3. With a small flat screwdriver gently separate the bottom case and boards assembly from the top cover
4. The circuit boards assembly will simply slide out of the case, as it is mechanically held in place by the bottom case only

---

#### Closing the case

5. Replace the circuit boards assembly inside the case; ensure that the terminal block connectors are aligned with the opening in the case
6. Replace the case bottom, then gently push the other side in place
7. Replace the black plastic DIN rail hook.



OPENING AND CLOSING THE CASE

## NOTICE

Static electricity can damage the components in your system. To protect your system's components from static damage during the installation process, touch any of the unpainted metal surfaces on your computer's frame or wear an ESD wrist strap before handling internal components. Either method will safely discharge static electricity that's naturally present in your body.

When handling the Iono RP D16 circuit boards, be sure to hold them along the side edges using your thumb and index finger. Avoid touching the components and pin connectors as damage may occur.

## Software development

Programming Iono RP D16 is as simple as any other RP2040-based boards, like the original Raspberry Pi Pico board.

You can program it in C/C++, MicroPython, or any other supported derived languages, using any IDE or tool available for the RP2040 microcontroller or Pico board.

Refer to the following link for an overview on how to get started with RP2040 programming:

<https://www.raspberrypi.org/documentation/rp2040/getting-started/>

For resources specific to Iono RP D16, go to:

<https://github.com/sfera-labs/iono-rp-d16>

The provided libraries implement various utilities as well as protection logic to prevent damage during hazard conditions. Moreover, examples and ready-to-use applications are included.

## Programming interfaces

Iono RP D16 features the same programming interfaces of the Pico board: USB and SWD.

### USB interface

The simplest way to program Iono RP D16 is by connecting it to a computer via USB, then dragging and dropping a program file onto it or using your IDE's features.

To set Iono RP D16 to *BOOTSEL mode* and have your computer see it as a USB Mass Storage Device:

- Remove power to Iono RP D16 and make sure the USB is unplugged;
- Push and hold the BOOTSEL button and connect the USB cable from your computer;
- Release the BOOTSEL button after Iono RP D16 is connected;
- It will mount as a Mass Storage Device called RPI-RP2.

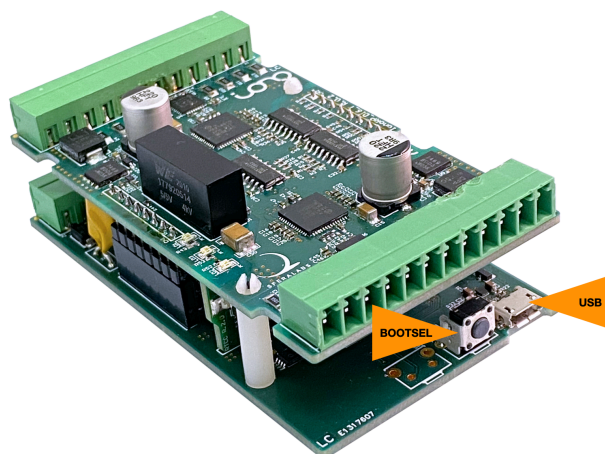

**BOOTSEL BUTTON AND USB CONNECTION**

Programming Iono RP D16 via USB does not require it to be connected to a power supply, but when powered only through USB most of Iono's I/O will not be functional.

---

## SWD interface

Serial Wire Debug (SWD) is a standard interface on Cortex-M-based microcontrollers, which the host computer can use to reset the board, load code into flash, set the code running, and interactively debug it.

Iono RP D16 exposes the RP2040 SWD interface on the CN1 header:



**SWD INTERFACE**

where the top pin (next to the CN1 marking) is the SWCLK line, the center pin is GND and the bottom pin is the SWDIO line.

When using the SWD interface Iono RP D16 needs to be connected to a power supply or powered via USB. You can use a standard debug probe, the GPIOs of a Raspberry Pi or a Pico board to connect to the SWD interface.

For more details, refer to chapter 5 and 6 of the "Getting started with Raspberry Pi Pico" guide:

<https://datasheets.raspberrypi.org/pico/getting-started-with-pico.pdf>

## Optional components

### Real Time Clock module

Iono RP D16 can be shipped with an optional, factory-installed hardware real time clock with a dedicated long-life non-rechargeable back-up battery.

The battery is only used to power the RTC chip when the main power is not available. Depending on operating conditions it should last up to two years if the Iono RP D16 board is not powered, more if the Iono RP D16 receives external power.

The RTC module is based on the NXP Semiconductor PCF2131 real-time clock/calendar chip. It is connected to the RP2040 via the I<sup>2</sup>C bus I2C0, GPIO0 (SDA) and GPIO1 (SCL), address: 0x53.

---

#### Replacing the RTC backup battery

The Iono RP D16 RTC module uses a **CR1220** Lithium / Manganese Dioxide (Li/MnO<sub>2</sub>) battery.



Improper handling of lithium batteries can result in an explosion of the batteries and/or release of harmful substances.

Worn-out or defective batteries can compromise the function of this product.

**KEEP OUT OF REACH OF CHILDREN.** Swallowing may lead to serious injury or death in as little as 2 hours due to chemical burns and potential perforation of the esophagus. Immediately see doctor.

Replace the RTC lithium battery before it is completely discharged. Replace the battery every 5 years even if the battery is still working properly. The lithium battery must be replaced only with an identical **CR1220** Lithium / Manganese Dioxide (Li/MnO<sub>2</sub>) battery.

Do not throw lithium batteries into fire, do not solder on the cell body, do not recharge, do not open, do not short-circuit, do not reverse polarity, do not heat above 100°C and protect from direct sunlight, moisture and condensation.

Dispose of used batteries according to local regulations and the battery manufacturer's instructions.

The RTC backup battery holder is soldered to the bottom layer of the RTC module circuit board. The battery is not accessible from the outside. You should first remove the case top body, and separate the top and bottom Iono RP D16 circuit boards, to gain access to the RTC backup battery.

# NOTICE

Before opening the Iono RP D16 Base case, disconnect all power sources and any connection to external devices, including USB cables.

Use a non-conductive pin or small tool to help extract the battery from its holder. Insert the new battery with a gentle push. You don't need tools to insert the battery. The battery is held into place by a spring contact.

Be sure to insert the battery so that the positive (+) terminal of the battery is in contact with the outer body of the battery holder, and the negative (-) terminal is in contact with the contact pad of the circuit board, as shown in the photo below.

Reversing the battery polarity may damage the product.

The real time clock will reset its time immediately when the RTC backup battery is disconnected.

## ATECC608 secure element

Iono RP D16 can be shipped with an optional, factory-installed hardware secure element chip, the ATECC608 from Microchip. The ATECC608 is connected to the to the RP2040 via the I<sup>2</sup>C bus I2C0, GPIO0 (SDA) and GPIO1 (SCL), address: 0x60.

Its key features are:

- ✓ Cryptographic co-processor with secure hardware-based key storage
- ✓ Protected storage for up to 16 Keys, certificates or data
- ✓ Hardware support for asymmetric sign, verify, key agreement – ECDSA: FIPS186-3 Elliptic Curve Digital Signature
  - ✓ ECDH: FIPS SP800-56A Elliptic Curve Diffie-Hellman
  - ✓ NIST standard P256 elliptic curve support
- ✓ Hardware support for symmetric algorithms
  - ✓ SHA-256 & HMAC hash including off-chip context save/restore
  - ✓ AES-128: encrypt/decrypt, Galois field multiply for GCM
- ✓ Networking key management support
  - ✓ Turnkey PRF/HKDF calculation for TLS 1.2 & 1.3
  - ✓ Ephemeral key generation and key agreement in SRAM – Small message encryption with keys entirely protected
- ✓ Secure boot support
  - ✓ Full ECDSA code signature validation, optional stored digest/signature – optional communication key disablement prior to secure boot
  - ✓ Encryption/Authentication for messages to prevent on-board attacks
- ✓ Internal high-quality FIPS 800-90 A/B/C Random Number Generator (RNG)
- ✓ Two high-endurance monotonic counters
- ✓ Guaranteed unique 72-bit serial number.

## Earthquake sensor module

Iono RP D16 can be shipped with an optional, factory-installed earthquake sensor module based on the OMRON D7S vibration sensor. It is connected to the RP2040 via the I<sup>2</sup>C bus I2C0, GPIO0 (SDA) and GPIO1 (SCL), address: 0x55.

This module is soldered to the bottom circuit board and cannot be removed by the user.





# Board layout

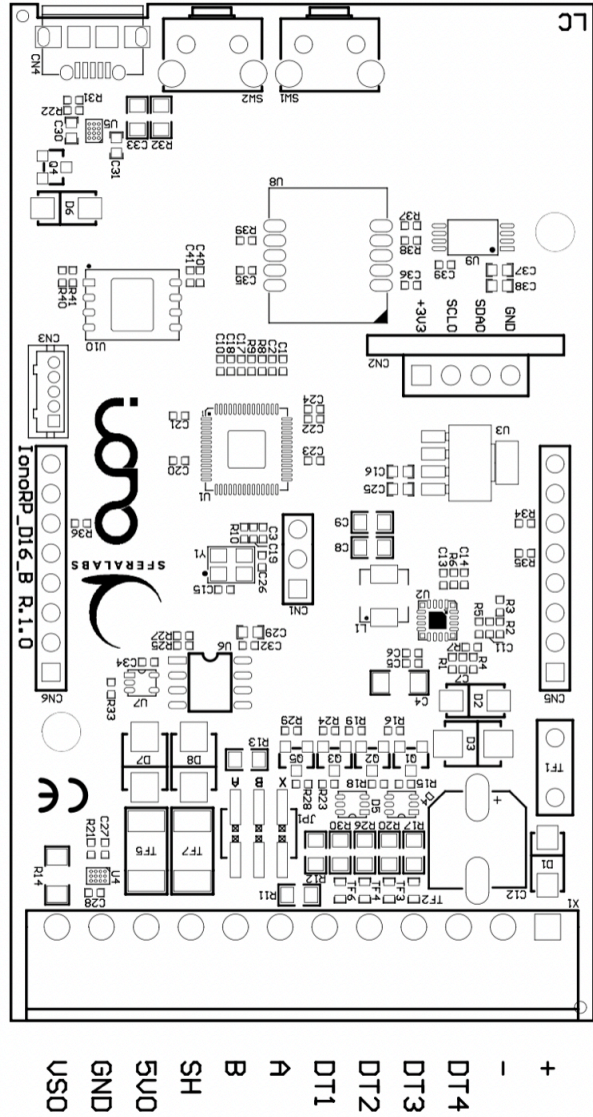
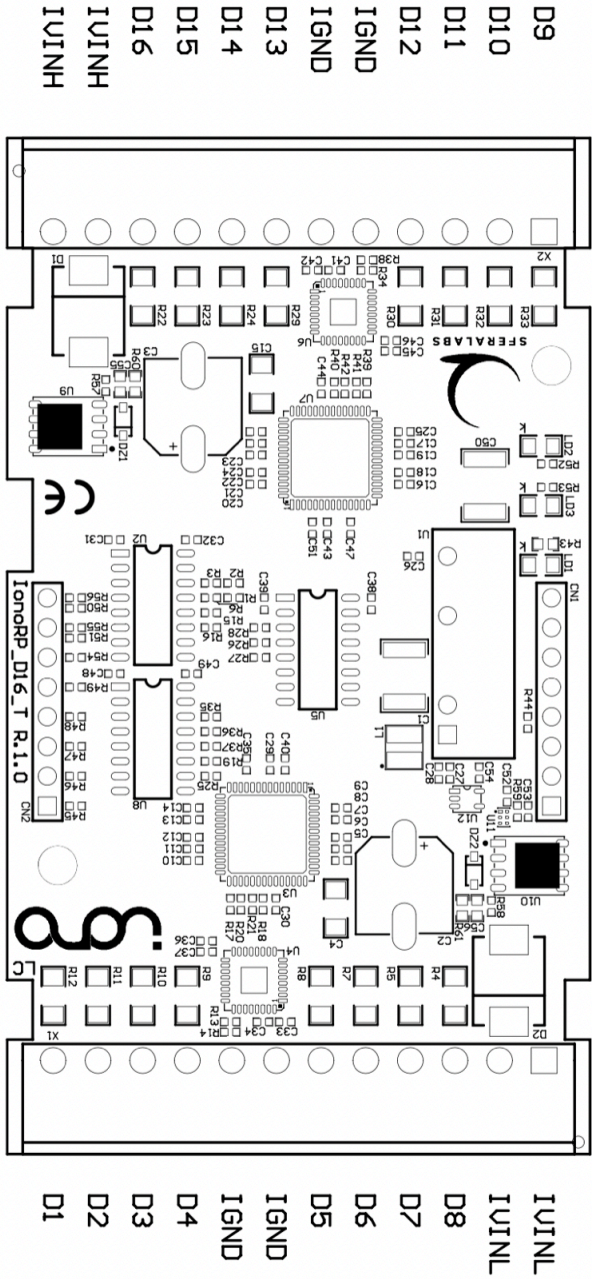

BOARD LAYOUT

## Technical specifications

<b>POWER SUPPLY</b>	
Power supply operating voltage (VS)	12...28 V <sub>DC</sub> nom. (10...30 V <sub>DC</sub> ) Reverse polarity protection with 1.1 A resettable fuse. Surge protection up to ±500 V / 2 Ohms 1.2/50 µs
Current consumption at VS+ 12V <sub>DC</sub> no I/O	55 mA
Current consumption at VS+ 24V <sub>DC</sub> no I/O	35 mA
IVINL supply operating voltage	12...28 V <sub>DC</sub> nom. (10.5...36 V <sub>DC</sub> )
IVINL input current	Max 20 mA + ∑ D1-D8
IVINH supply operating voltage	12...28 V <sub>DC</sub> nom. (10.5...36 V <sub>DC</sub> )
IVINH input current	Max 20 mA + ∑ D9-D16
VSO output voltage (min.)	VS - 1 V
VSO output current (max.)	300 mA
5VO output voltage (typ.)	5.0 V (no load)
5VO output current (max.)	350 mA
5VO overcurrent protection threshold	420 mA
USB port output current (max.)	500 mA
<b>ARCHITECTURE</b>	
Microcontroller	Raspberry Pi RP2040 dual-core Arm Cortex M0+, 133 MHz, 264KB SRAM 16MB on-board Flash memory
<b>COMMUNICATION PORTS</b>	
Serial communication ports	RS-485 Half-Duplex with manual or automatic TX/RX management
Baud Rates	1200 to 115200
ESD-Protection Voltage on RS-485 A/B	±15 kV human body model ±8 kV contact discharge
Surge protection on RS-485 A/B	Surge protection up to ±500 V / 2 Ohms 1.2/50 µs; 600 W peak pulse power capability at 10/1000 µs waveform
Fail safe feature on RS-485	Optional with jumpers (not installed)
USB port	Micro-USB B Receptacle USB 1.1, host and device support
<b>D1-D16: DIGITAL INPUTS</b>	

Input voltage range	+0...+36 V never apply voltages higher than IVINL to the D1-D8 lines or higher than IVINH to the D9-D16 lines
Input current	2.4 mA
Voltage thresholds	Compatible with EN 61131-2 Type I and III sensors VIH: 9.9 V VIL: 7.4 V
<b>D1-D16: DIGITAL OUTPUTS</b>	
Driver mode	high-side or push-pull
Maximum current per output	640 mA
HS or PP high-side on-resistance	110 mOhm (Max 230 mOhm)
PP low-side on-resistance	1 Ohm (Max 2.5 Ohm)
<b>DT1-DT4: DIGITAL INPUT/OUTPUT</b>	
Output voltage	VOL: 0.1 V VOH: 5.0 V
Input voltage threshold	VIH: 1.4 V VIL: 1.1 V
Pull-up (+5 V)	10 kOhm
Max cable length	10 meters
<b>EERAM</b>	
Capacity	16 Kbit (2048 x 8 bits)
SRAM r/w cycles	Infinite
EEPROM store cycles	> 1000000
Data retention	> 200 years
<b>EMI IMMUNITY STANDARDS</b>	
Electromagnetic immunity compliance	EN 61000-4-2 (ESD) EN 61000-4-3 (Radiated RF Field) EN 61000-4-4 (Burst/fast transient) EN 61000-4-5 (Surge) EN 61000-4-6 (Conducted) EN 61000-4-8 (Power frequency magnetic field)
<b>ENVIRONMENTAL</b>	
Operating temperature	-20...+60 °C (non-condensing humidity)
Relative humidity	5% to 90% noncondensing
Storage temperature	-30...+80 °C
Protection degree	IP20
<b>MECHANICAL</b>	

3.81 mm pitch terminal block characteristics	<p>Maximum conductor cross section: 1.3 mm<sup>2</sup> (16AWG), or 0.5 mm<sup>2</sup> when using ferrules (highly recommended)</p> <p>Recommended stripping length: 6 mm</p> <p>Screw thread: M2</p> <p>Maximum screws tightening torque: 0.3 Nm</p>
Dimensions	<p>3 module Din Rail enclosure</p> <p>width: 53.5 mm</p> <p>height: 90.5mm</p> <p>depth: 62.0mm</p>
Weight	135 gr

# Dimensions

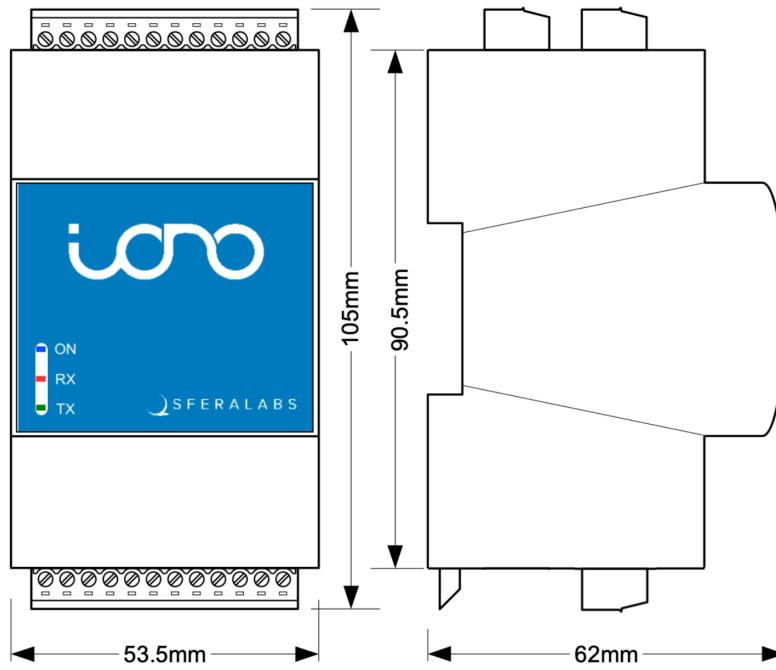

**DIMENSIONS**

## Disposal

(Waste Electrical & Electronic Equipment)



(Applicable in the European Union and other European countries with separate collection systems). This marking on the product, accessories or literature indicates that the product should not be disposed of with other household waste at the end of their working life. To prevent possible harm to the environment or human health from uncontrolled waste disposal, please separate these items from other types of waste and recycle them responsibly to promote the sustainable reuse of material resources. Household users

should contact either the retailer where they purchased this product, or their local government office, for details of where and how they can take these items for environmentally safe recycling. This product and its electronic accessories should not be mixed with other commercial wastes for disposal.

Iono RP D16 optionally contains a small non rechargeable manganese dioxide lithium coin battery. The battery is not accessible from the outside. You should first remove the case body to gain access to the Iono RP D16 circuit boards. Always remove the battery before disposing of this product.

## Installation and use restrictions

### Standards and regulations

The design and the setting up of electrical systems must be performed according to the relevant standards, guidelines, specifications and regulations of the relevant country. The installation, configuration and programming of the devices must be carried out by trained personnel.

The installation and wiring of connected devices must be performed according to the recommendations of the manufacturers (reported on the specific data sheet of the product) and according to the applicable standards.

All the relevant safety regulations, e.g. accident prevention regulations, law on technical work equipment, must also be observed.

### Safety instructions

Carefully read the safety information section at the beginning of this document.

### Set-up

For the first installation of the device proceed according to the following procedure:

- ✓ make sure all power supplies are disconnected
- ✓ install and wire the device according to the schematic diagrams on the specific data sheet of the product
- ✓ after completing the previous steps, switch on the 230 Vac supplying the power supply and the other related circuits.

## Conformity Information

### EU

This device complies with the following applicable European Community harmonised standards:

- ✓ 2014/30/EU - Electromagnetic Compatibility Directive (EMC)
- ✓ 2011/65/EU and 2015/863/EU - Restriction of the use of certain hazardous substances in electrical and electronic equipment (RoHS)

The following harmonised standards have been used to demonstrate conformity to these directives:

- ✓ EN61000-6-2:2019 - EMC Immunity for industrial environments
- ✓ EN 61000-6-3:2021 - EMC Emission standard for residential, commercial and light-industrial environments

The declaration of conformity is available at: <https://www.sferalabs.cc>

### USA

This equipment has been tested and found to comply with the limits for a Class B digital device, pursuant to part 15 of the FCC Rules. These limits are designed to provide reasonable protection against harmful interference in a residential installation. This equipment generates, uses and can radiate radio frequency energy and, if not installed and used in accordance with the instructions, may cause harmful interference to radio communications. However, there is no guarantee that interference will not occur in a particular installation. If this equipment does cause harmful interference to radio or television reception, which can be determined by turning the equipment off and on, the user is encouraged to try to correct the interference by one or more of the following measures:

- Reorient or relocate the receiving antenna
- Increase the separation between the equipment and receiver
- Connect the equipment into an outlet on a circuit different from that to which the receiver is connected
- Consult the dealer or an experienced radio/TV technician for help.

Shielded cables must be used with this equipment to maintain compliance with FCC regulations.

This device complies with Part 15 of the FCC Rules. Operation is subject to the following two conditions: (1) this device may not cause harmful interference, and (2) this device must accept any interference received, including interference that may cause undesired operation.

### CANADA

This Class B digital apparatus complies with Canadian ICES-003(B).

Cet appareil numérique de la classe B est conforme à la norme NMB-003(B) du Canada.

## **RCM AUSTRALIA / NEW ZEALAND**

This product meets the requirements of the standard EN 61000-6-3:2021 - Emission for residential, commercial and light-industrial environments.