

FS3000

Air Velocity Sensor Module

The [FS3000](#) is a surface-mount type air velocity module that uses a MEMS thermopile-based sensor.

The FS3000 features a digital output with 12-bit resolution. The sensor comprises a “solid” thermal isolation technology and silicon-carbide coating to protect it from abrasive wear and water condensation.

The module features a compact design fit for low profile enclosures.

Features

- Robust “solid” isolation technology
- Resistant to surface contamination
- Resistant to vibration and pressure shock
- Low power application
- Digital output: I²C
- Supply voltage: 3.3V
- Module operating temperature range: -20°C to +85°C
- Module size: 8 × 9 × 4 mm

Applications

- Data center and servers
- HVAC and air control systems
- Laminar flow control systems
- Air filtration and collection systems

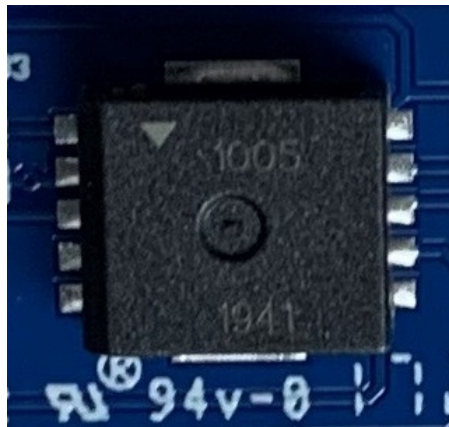

Figure 1. FS3000 Air Velocity Module

Contents

1. Pin Information	3
1.1 Pin Assignments	3
1.2 Pin Descriptions	3
2. Application Circuit	4
3. Specifications	5
3.1 Absolute Maximum Ratings	5
3.2 Recommended Operating Conditions	5
3.3 Electrical Characteristics	5
4. Typical Flow Graphs	6
5. Functional Description	8
5.1 I ² C Sensor Interface	8
5.1.1. Sensor Slave Address	8
5.1.2. I ² C Communication	8
5.2 Digital Output Measurements	9
5.3 Calculating Checksum	10
6. Module Drawings	11
7. Ordering Information	12
8. Revision History	12

1. Pin Information

1.1 Pin Assignments

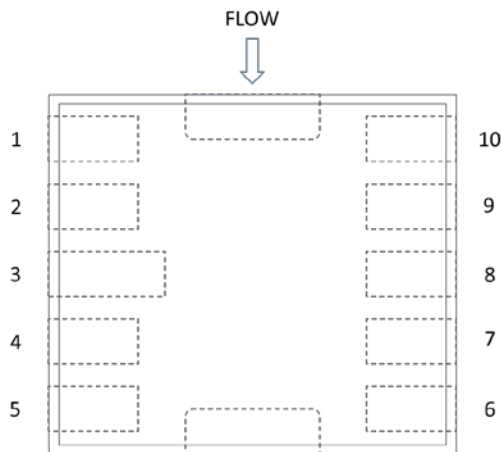

1.2 Pin Descriptions

Table 1. Pin Descriptions

Pin Number	Pin Name	Type	Description
1	V _{REG}	Input	ADC reference input.
2	V _{IN}	Input	Supply voltage.
3	GND	Ground	Ground.
4	NC	-	Do not connect.
5	NC	-	Do not connect.
6	SDA	Input/Output	Serial data.
7	SCL	Input	Serial clock.
8	TP1	Input/Output	Connect with capacitor.
9	TP2	Input/Output	Connect with capacitor.
10	V _{CM}	Output	Common bias.

2. Application Circuit

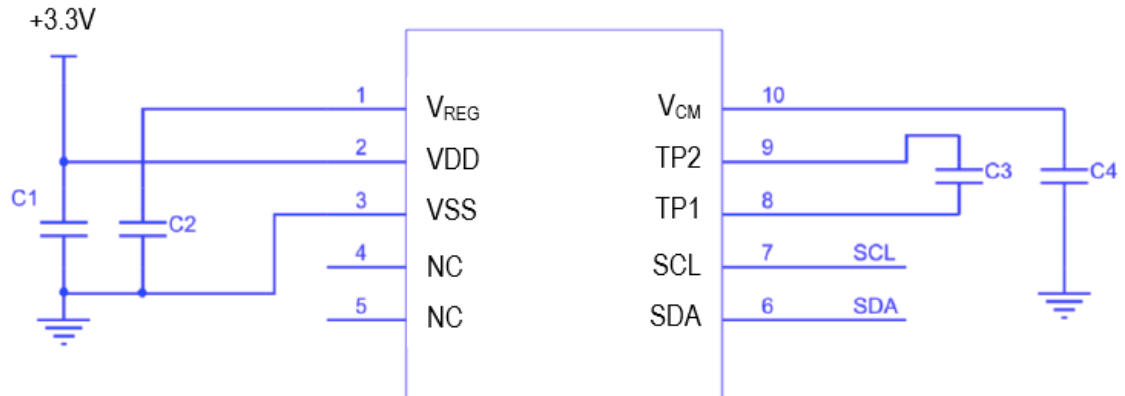

Note:

- C1, C2, C3 are 0.1μF capacitors
- C4 is a 1μF capacitor

3. Specifications

3.1 Absolute Maximum Ratings

The absolute maximum ratings are stress ratings only. Stresses greater than those listed below can cause permanent damage to the device. Functional operation of the FS3000 at absolute maximum ratings is not implied. Exposure to absolute maximum rating conditions may affect device reliability.

Symbol	Parameter	Conditions	Minimum	Maximum	Unit
V _{IN}	Supply Voltage	-	-	5.5	V
T _{STOR}	Storage Temperature	-	-40	105	°C

3.2 Recommended Operating Conditions

Symbol	Parameter	Minimum	Typical	Maximum	Unit
V _{IN}	Supply Voltage ^[1]	-	3.3	-	V
T _{AMB}	Ambient Operating Temperature	-20	-	85	°C

1. Must be regulated; changes in supply voltage will affect accuracy.

3.3 Electrical Characteristics

Symbol	Parameter	Conditions	Minimum	Typical	Maximum	Unit
I _{VIN}	Current Consumption	-	-	10	-	mA
F _{AIR}	Air Flow Range	FS3000-1005	0	-	7.23	m/sec
		FS3000-1015	0	-	15	
V _{OUT}	Digital Output	Min to Max of Flow Range	409	-	3686	Count
RES	Resolution	-	-	-	12	bit
E _{AIR}	Flow Accuracy	At 25°C	-	5	-	% of F.S.
t _{RESP}	Response Time	-	-	125	-	ms
f _{SCL}	SCL Clock Frequency	-	-	-	400	kHz
V _{IL}	I ² C Input Logic Low Threshold	-	-	-	0.3V _{DD} or 1.5	V
V _{IH}	I ² C Input Logic High Threshold	-	0.7V _{DD} or 3	-	-	V
V _{OL}	I ² C Output Logic Low Threshold	-	-	-	0.4	V

1. m/sec: meter per second.
2. F.S: Full scale flow range.

4. Typical Flow Graphs

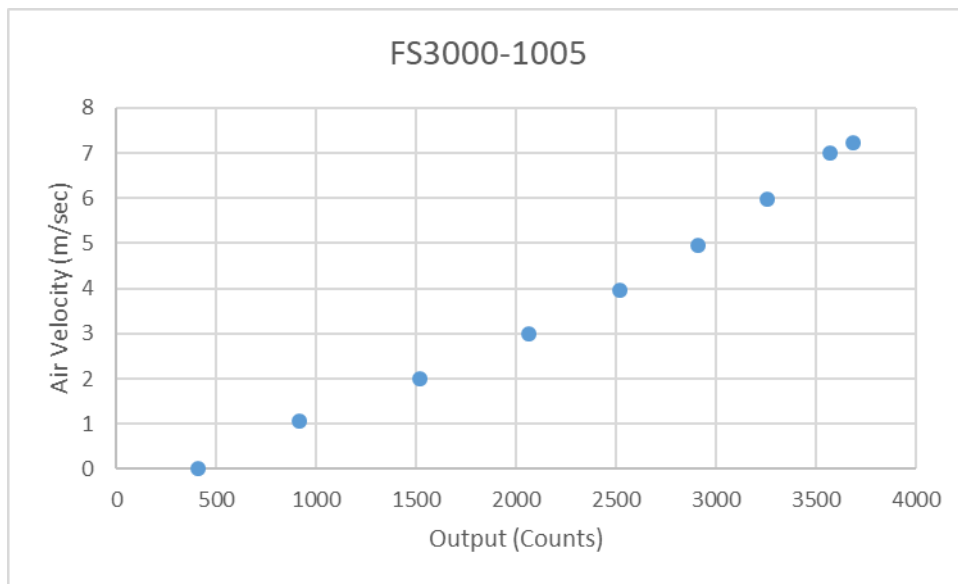

Figure 2. FS3000-1005 Output

Air Velocity (m/sec)	Output (Count)
0	409
1.07	915
2.01	1522
3.00	2066
3.97	2523
4.96	2908
5.98	3256
6.99	3572
7.23	3686

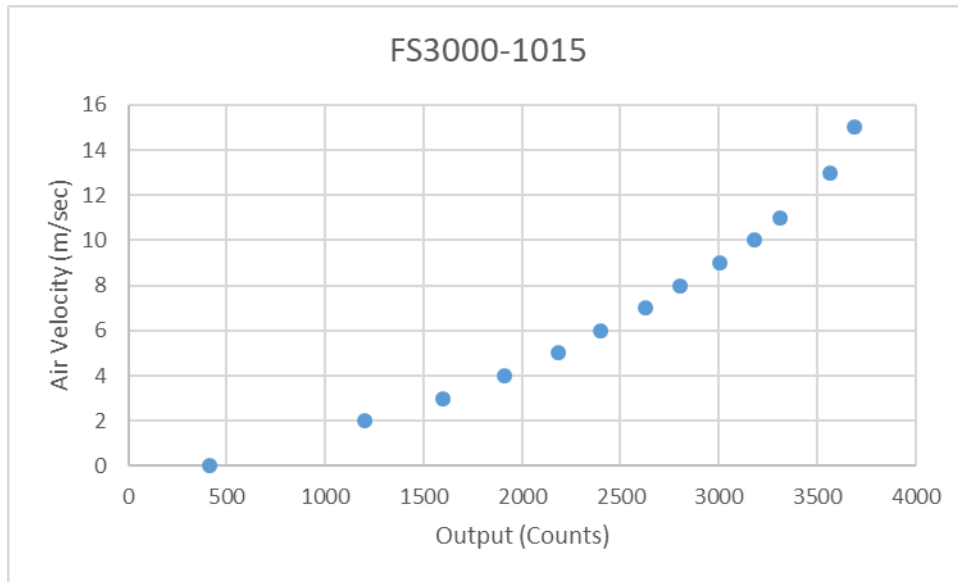

Figure 3. FS3000-1015 Output

Air Velocity (m/sec)	Output (Count)
0	409
2.00	1203
3.00	1597
4.00	1908
5.00	2187
6.00	2400
7.00	2629
8.00	2801
9.00	3006
10.00	3178
11.00	3309
13.00	3563
15.00	3686

5. Functional Description

5.1 I²C Sensor Interface

The FS3000 includes an I²C digital, two-wire interface with a bidirectional data line (SDA) and a clock line (SCL). The two lines are open drain and connected to the supply voltage via two pull-up resistors (Rp). The FS3000 operates as a slave device on the I²C bus with support of 100kHz and 400kHz bit rates.

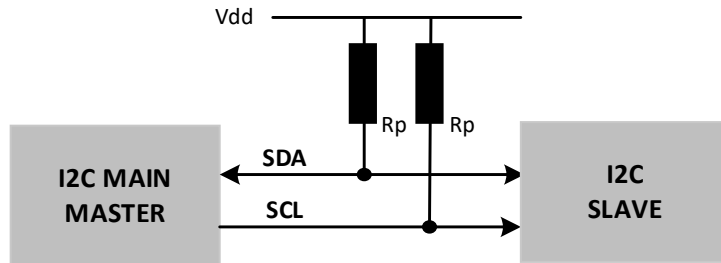

Figure 4. I²C Master-Slave Configuration

The recommended pull-up resistor (Rp) values depend on the system implementation, but a value between 2.2kΩ and 10kΩ can be used.

The capacitive load on both SDA and SCL should be the same; therefore, the signal lengths should be similar to avoid asymmetry.

5.1.1. Sensor Slave Address

The FS3000 default I²C address is 28_{HEX}. The device will respond only to this 7-bit address.

5.1.2. I²C Communication

The START condition is used to initiate I²C communication by the master. The sensor transmission is initiated when the master sends a 0 START bit (S). A HIGH-to-LOW transition on the SDA line while the SCL is HIGH indicates the beginning of a transmission.

The STOP condition is used to stop I²C communication by the master. The transmission is terminated when the master sends a 1 STOP bit (P). A LOW-to-HIGH transition on the SDA line while the SCL is HIGH indicates the end of a transmission.

All transfers consist of 8 bits and a response bit: 0 for Acknowledge (ACK) or 1 for Not Acknowledge (NACK). After the ACK is received, another data byte can be transferred or the communication can be stopped with a STOP bit.

The master expects an ACK back from the slave after each byte is transmitted. The slave pulls the SDA low to indicate that it has received a byte and then it frees the I²C bus again. If the slave does not initiate an ACK then it will consider it a NACK.

Data on the SDA line is always sampled on the rising edge of the SCL line and must remain stable while SCL is HIGH to prevent false START or STOP conditions.

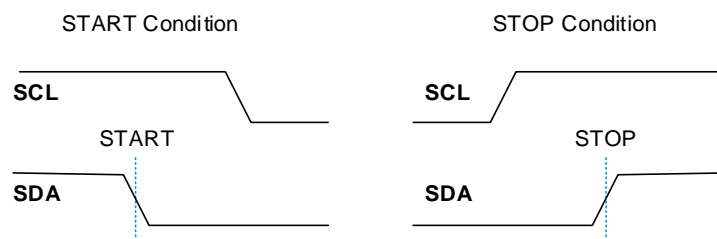

Figure 5. START and STOP Condition Waveform

5.3 Calculating Checksum

The checksum used for data integrity is the 2's complement (negative) of the 256-modulo (8-bit) sum of the data bytes (does not include I²C address).

Figure 7 shows the 5 bytes read:

Example:

Byte 1, 0xCC (Checksum)

Byte 2, 0x01

Byte 3, 0x99

Byte 4, 0x01 or 0x00

Byte 5, 0x99 or 0x00

The 256-modulo (8-bit) sum is calculated as:

$$sum = 0x01 + 0x99 + 0x01 + 0x99 = 0x134$$

Validating the data payload is done by calculating the sum and adding it to the checksum. If the result is 0x00, then the data is valid.

$$checksum + sum = 0xCC + 0x134 = 0x00$$

6. Module Drawings

All dimensions are in mm.

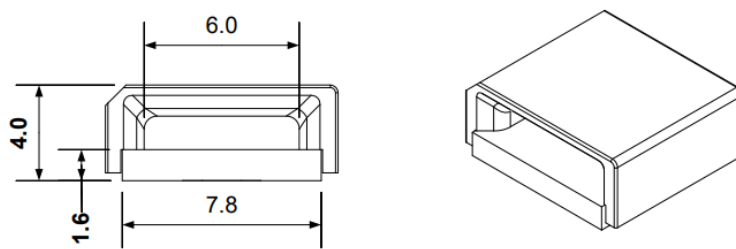
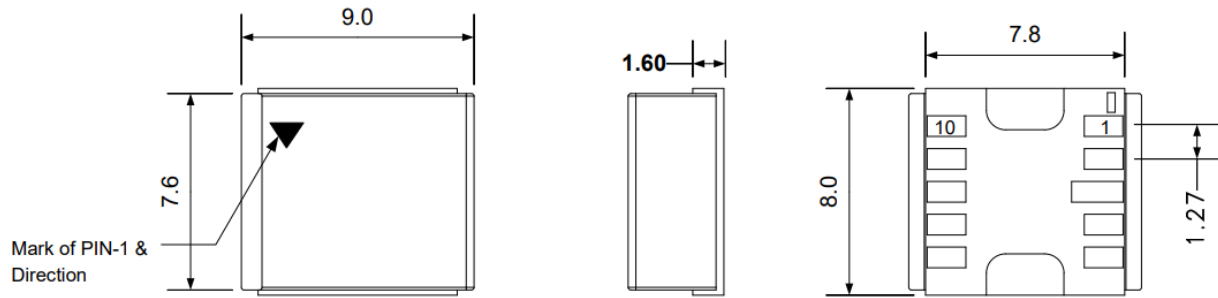

PCB Footprint

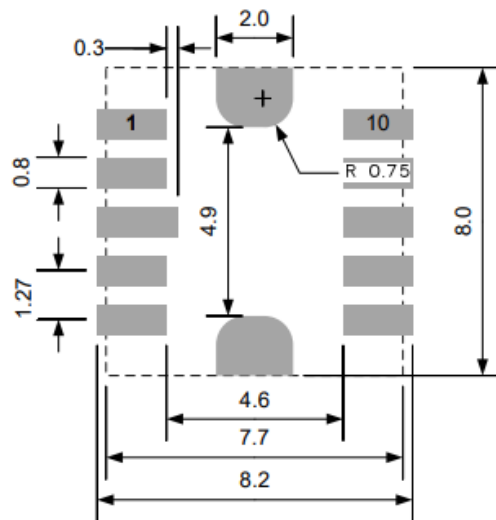

7. Ordering Information

Part Number	Description	MSL Rating	Carrier Type	Temperature Range
FS3000-1005	0 to 7 m/sec air velocity module	3	Reel	-20°C to +85°C
FS3000-1015	0 to 15 m/sec air velocity module	3		

8. Revision History

Revision	Date	Description
1.01	Feb 6, 2023	Corrected module dimension height in Features description on first page.
1.00	May 31, 2022	Initial release.

IMPORTANT NOTICE AND DISCLAIMER

RENESAS ELECTRONICS CORPORATION AND ITS SUBSIDIARIES (“RENESAS”) PROVIDES TECHNICAL SPECIFICATIONS AND RELIABILITY DATA (INCLUDING DATASHEETS), DESIGN RESOURCES (INCLUDING REFERENCE DESIGNS), APPLICATION OR OTHER DESIGN ADVICE, WEB TOOLS, SAFETY INFORMATION, AND OTHER RESOURCES “AS IS” AND WITH ALL FAULTS, AND DISCLAIMS ALL WARRANTIES, EXPRESS OR IMPLIED, INCLUDING, WITHOUT LIMITATION, ANY IMPLIED WARRANTIES OF MERCHANTABILITY, FITNESS FOR A PARTICULAR PURPOSE, OR NON-INFRINGEMENT OF THIRD-PARTY INTELLECTUAL PROPERTY RIGHTS.

These resources are intended for developers who are designing with Renesas products. You are solely responsible for (1) selecting the appropriate products for your application, (2) designing, validating, and testing your application, and (3) ensuring your application meets applicable standards, and any other safety, security, or other requirements. These resources are subject to change without notice. Renesas grants you permission to use these resources only to develop an application that uses Renesas products. Other reproduction or use of these resources is strictly prohibited. No license is granted to any other Renesas intellectual property or to any third-party intellectual property. Renesas disclaims responsibility for, and you will fully indemnify Renesas and its representatives against, any claims, damages, costs, losses, or liabilities arising from your use of these resources. Renesas' products are provided only subject to Renesas' Terms and Conditions of Sale or other applicable terms agreed to in writing. No use of any Renesas resources expands or otherwise alters any applicable warranties or warranty disclaimers for these products.

(Disclaimer Rev.1.01 Jan 2024)

Corporate Headquarters

TOYOSU FORESIA, 3-2-24 Toyosu,
Koto-ku, Tokyo 135-0061, Japan
www.renesas.com

Trademarks

Renesas and the Renesas logo are trademarks of Renesas Electronics Corporation. All trademarks and registered trademarks are the property of their respective owners.

Contact Information

For further information on a product, technology, the most up-to-date version of a document, or your nearest sales office, please visit www.renesas.com/contact-us/.