

»Features

- Excellent clamping capability
- Low leakage current
- Low capacitance
- High surge capability
- Glass passivated chip
- Epoxy resin package
- Built-in strain relief
- Will not fatigue
- RoHS Compliant
- Fast response time:
typically less than 1.0ps from 0 Volts to V_{BR} min



SMB (DO-214AA)

»Mechanical Characteristics

- Package: SMB plastic package.
- Lead Finish: Matte Tin
- Case Material: Epoxy Molding Compound.
- UL Flammability Classification Rating 94V-0
- Moisture Sensitivity: Level 1 per J-STD-020

»Applications

- Telecom
- Computer
- Industrial electronic
- Consumer electronic

»Electrical Parameters

Parameter	Definition
C_J	Junction Capacitance - typical capacitance measured with 0V or V_R bias
I_{PP}	Peak Pulse Current - maximum rated peak impulse current
V_C	Clamping Voltage - Peak voltage measured across the suppressor at a specified I_{ppm} (peak impulse current)
V_{BR}	Breakdown Voltage - Maximum voltage that flows through the TVS at a specified test current (I_T)
I_R	Leakage Current - maximum peak off-state current measured at V_R
V_R	Peak Off-state Voltage - maximum voltage that can be applied while maintaining off state

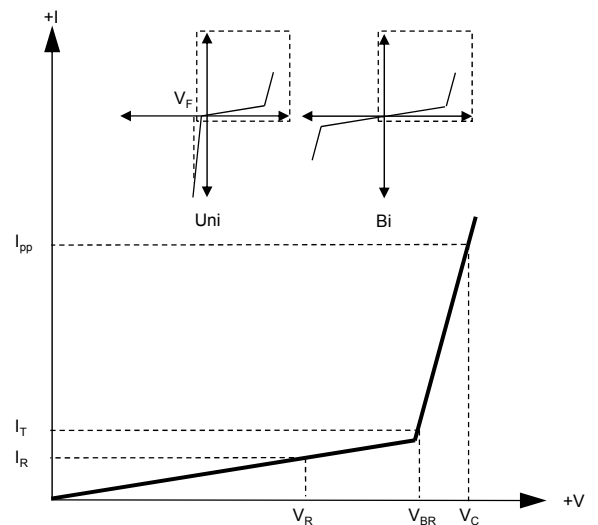

»Summary of Packing Options

Package	Packing Description	Packing Quantity	Industry Standard
SMB	Tape/Reel, 13" reel	3000	EIA-481-1
	Tape/Reel, 7" reel	500	EIA-481-1

»Absolute Maximum Ratings ($T_A=25^\circ\text{C}$ unless otherwise noted)

Parameter	Symbol	Value	Units	Remarks
Peak Pulse Power Dissipation	P_{PPM}	600	W	(Note1)(Note2)
Steady State Power Dissipation	P_D	5	W	(Note3)
Peak Forward Surge Current	I_{FSM}	100	A	(Note4)
Maximum Instantaneous Forward Voltage at 50A	V_{FM}	3.5/5	V	(Note5)
Typical Thermal Resistance Junction to Lead	$R_{\theta JL}$	20	$^\circ\text{C}/\text{W}$	
Typical Thermal Resistance Junction to Ambient	$R_{\theta JA}$	100	$^\circ\text{C}/\text{W}$	
Operating Temperature Range	T_J	-55 to 150	$^\circ\text{C}$	
Storage Temperature Range	T_{STG}	-55 to 150	$^\circ\text{C}$	

Notes1: Non-repetitive current pulse , 10/1000us Waveform.

Notes2: Mounted on copper pad area of 5×5mm to each terminal.

Notes3: Infinite HeatSink at $T_A=50^\circ\text{C}$

Notes4: Measured on 8.3ms single half sine wave or equivalent square wave, duty cycle=4 perminute maximum.

Notes5: For UnidirectionalOnly, $V_{FM}<3.5\text{V}$ for $V_{BR} \leq 200\text{V}$ and $V_{FM}<5.0\text{V}$ for $V_{BR} \geq 201\text{V}$.

»Electrical Characteristics ($T_A=25^\circ\text{C}$ unless otherwise noted)

Part Number (Uni)	Part Number (Bi)	Marking Code		Reverse Stand off Voltage V_R (V)	Breakdown Voltage $V_{BR} @ I_T$ (V)		Test Current I_T (mA)	Maximum Clamping Voltage $V_C @ I_{PP}$ (V)	Maximum Peak Pulse Current I_{PP} (A)	Maximun Reverse Leakage $I_R @ V_R$ (μA)
		Uni	Bi		Min	Max				
SMBJ5.0A	SMBJ5.0CA	KE	AE	5	6.4	7	10	9.2	65.3	800
SMBJ6.0A	SMBJ6.0CA	KG	AG	6	6.67	7.37	10	10.3	58.3	800
SMBJ6.5A	SMBJ6.5CA	KK	AK	6.5	7.22	7.98	10	11.2	53.6	500
SMBJ7.0A	SMBJ7.0CA	KM	AM	7	7.78	8.6	10	12	50	200
SMBJ7.5A	SMBJ7.5CA	KP	AP	7.5	8.33	9.21	1	12.9	46.6	100
SMBJ8.0A	SMBJ8.0CA	KR	AR	8	8.89	9.83	1	13.6	44.2	50
SMBJ8.5A	SMBJ8.5CA	KT	AT	8.5	9.44	10.4	1	14.4	41.7	20
SMBJ9.0A	SMBJ9.0CA	KV	AV	9	10	11.1	1	15.4	39	10
SMBJ10A	SMBJ10CA	KX	AX	10	11.1	12.3	1	17	35.3	5
SMBJ11A	SMBJ11CA	KZ	AZ	11	12.2	13.5	1	18.2	33	1
SMBJ12A	SMBJ12CA	LE	BE	12	13.3	14.7	1	19.9	30.2	1
SMBJ13A	SMBJ13CA	LG	BG	13	14.4	15.9	1	21.5	28	1
SMBJ14A	SMBJ14CA	LK	BK	14	15.6	17.2	1	23.2	25.9	1
SMBJ15A	SMBJ15CA	LM	BM	15	16.7	18.5	1	24.4	24.6	1
SMBJ16A	SMBJ16CA	LP	BP	16	17.8	19.7	1	26	23.1	1
SMBJ17A	SMBJ17CA	LR	BR	17	18.9	20.9	1	27.6	21.8	1
SMBJ18A	SMBJ18CA	LT	BT	18	20	22.1	1	29.2	20.6	1
SMBJ20A	SMBJ20CA	LV	BV	20	22.2	24.5	1	32.4	18.6	1
SMBJ22A	SMBJ22CA	LX	BX	22	24.4	26.9	1	35.5	16.9	1
SMBJ24A	SMBJ24CA	LZ	BZ	24	26.7	29.5	1	38.9	15.5	1

»Electrical Characteristics ($T_A=25^{\circ}\text{C}$ unless otherwise noted)

Part Number (Uni)	Part Number (Bi)	Marking Code		Reverse Stand off Voltage V_R (V)	Breakdown Voltage $V_{BR} @ I_T$ (V)		Test Current I_T (mA)	Maximum Clamping Voltage $V_C @ I_{PP}$ (V)	Maximum Peak Pulse Current I_{PP} (A)	Maximun Reverse Leakage $I_R @ V_R$ (μA)
		Uni	Bi		Min	Max				
SMBJ26A	SMBJ26CA	ME	CE	26	28.9	31.9	1	42.1	14.3	1
SMBJ28A	SMBJ28CA	MG	CG	28	31.1	34.4	1	45.4	13.3	1
SMBJ30A	SMBJ30CA	MK	CK	30	33.3	36.8	1	48.4	12.4	1
SMBJ33A	SMBJ33CA	MM	CM	33	36.7	40.6	1	53.3	11.3	1
SMBJ36A	SMBJ36CA	MP	CP	36	40	44.2	1	58.1	10.4	1
SMBJ40A	SMBJ40CA	MR	CR	40	44.4	49.1	1	64.5	9.3	1
SMBJ43A	SMBJ43CA	MT	CT	43	47.8	52.8	1	69.4	8.7	1
SMBJ45A	SMBJ45CA	MV	CV	45	50	55.3	1	72.7	8.3	1
SMBJ48A	SMBJ48CA	MX	CX	48	53.3	58.9	1	77.4	7.8	1
SMBJ51A	SMBJ51CA	MZ	CZ	51	56.7	62.7	1	82.4	7.3	1
SMBJ54A	SMBJ54CA	NE	DE	54	60	66.3	1	87.1	6.9	1
SMBJ58A	SMBJ58CA	NG	DG	58	64.4	71.2	1	93.6	6.5	1
SMBJ60A	SMBJ60CA	NK	DK	60	66.7	73.7	1	96.8	6.2	1
SMBJ64A	SMBJ64CA	NM	DM	64	71.1	78.6	1	103	5.9	1
SMBJ70A	SMBJ70CA	NP	DP	70	77.8	86	1	113	5.3	1
SMBJ75A	SMBJ75CA	NR	DR	75	83.3	92.1	1	121	5	1
SMBJ78A	SMBJ78CA	NT	DT	78	86.7	95.8	1	126	4.8	1
SMBJ85A	SMBJ85CA	NV	DV	85	94.4	104	1	137	4.4	1
SMBJ90A	SMBJ90CA	NX	DX	90	100	111	1	146	4.1	1
SMBJ100A	SMBJ100CA	NZ	DZ	100	111	123	1	162	3.7	1
SMBJ110A	SMBJ110CA	PE	EE	110	122	135	1	177	3.4	1
SMBJ120A	SMBJ120CA	PG	EG	120	133	147	1	193	3.1	1
SMBJ130A	SMBJ130CA	PK	EK	130	144	159	1	209	2.9	1
SMBJ150A	SMBJ150CA	PM	EM	150	167	185	1	243	2.5	1
SMBJ160A	SMBJ160CA	PP	EP	160	178	197	1	259	2.3	1
SMBJ170A	SMBJ170CA	PR	ER	170	189	209	1	275	2.2	1
SMBJ180A	SMBJ180CA	PT	ET	180	201	222	1	292	2.1	1
SMBJ200A	SMBJ200CA	PX	EX	200	224	247	1	324	1.9	1
SMBJ220A	SMBJ220CA	QE	FE	220	246	272	1	356	1.7	1
SMBJ250A	SMBJ250CA	QG	FG	250	279	309	1	405	1.5	1
SMBJ300A	SMBJ300CA	QK	FK	300	335	371	1	486	1.3	1
SMBJ350A	SMBJ350CA	QM	FM	350	391	432	1	567	1.1	1
SMBJ400A	SMBJ400CA	QP	FP	400	447	494	1	648	0.9	1
SMBJ440A	SMBJ440CA	QR	FR	440	492	543	1	713	0.9	1
SMBJ480A	SMBJ480CA	QT	FT	480	536	593	1	750	0.8	1

»Rating And Characteristic Curves ($T_A=25^\circ\text{C}$ unless otherwise noted)

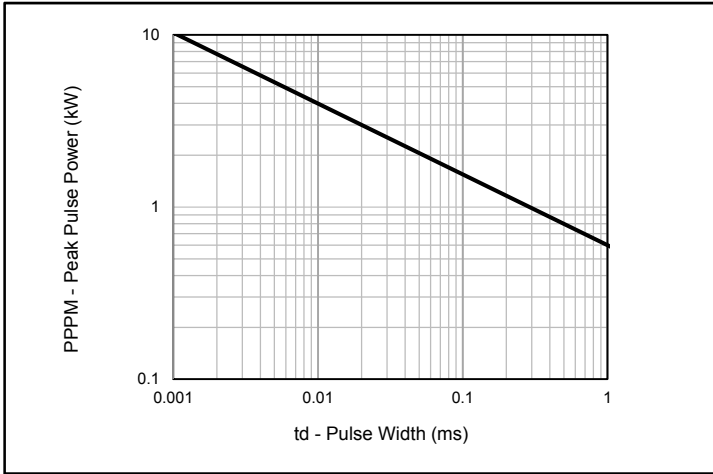

Fig.1 - Peak Pulse Power Rating

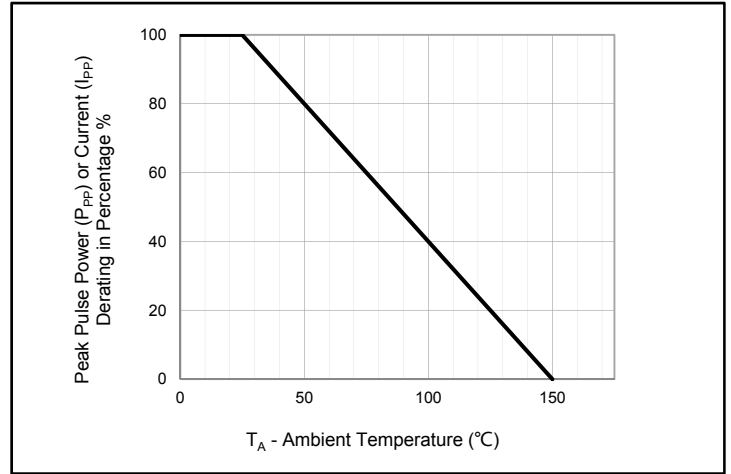

Fig.2 - Pulse Derating Curve

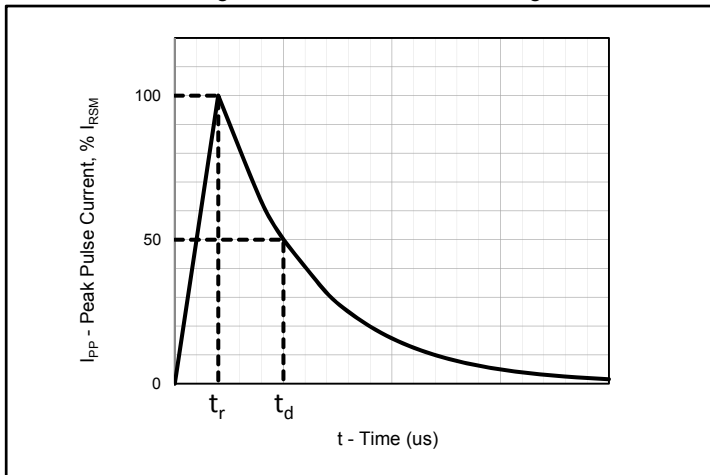

Fig.3 - Pulse Waveform

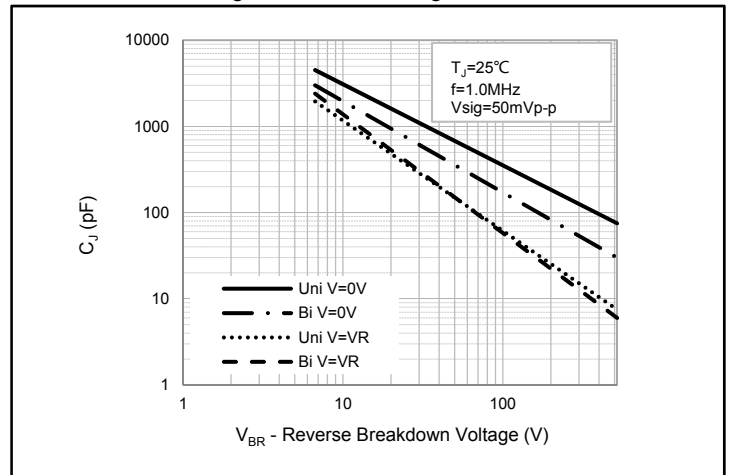

Fig.4 - Typical Junction Capacitance

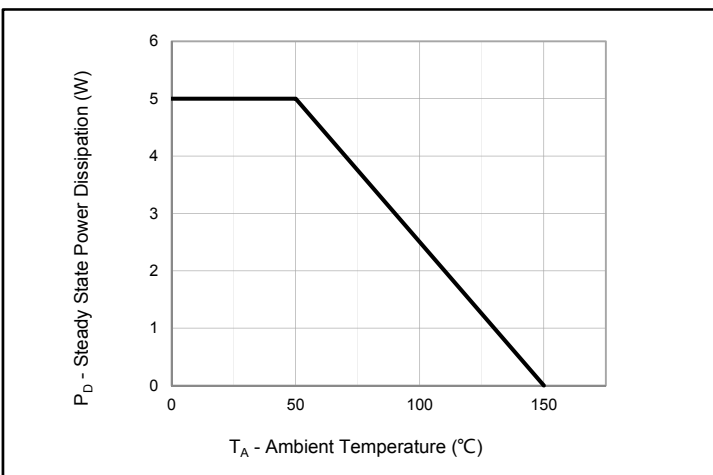

Fig.5 - Steady State Power Dissipation Derating Curve

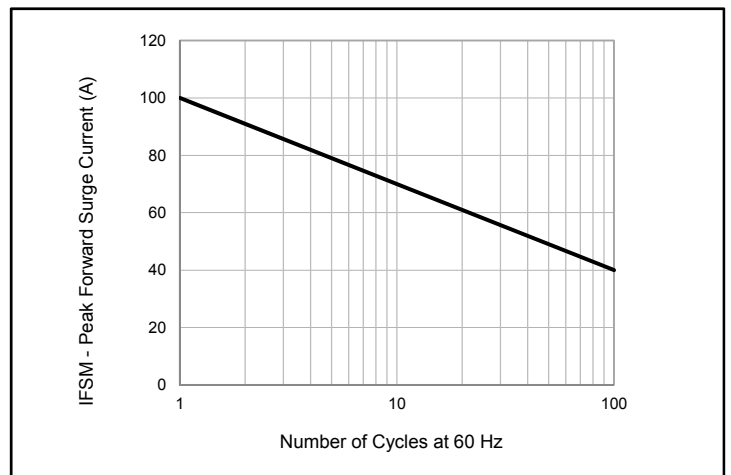
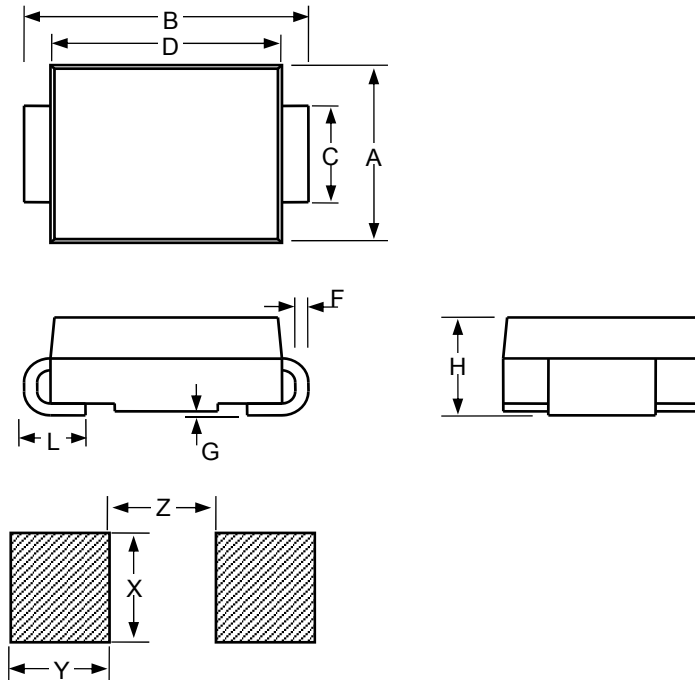

Fig.6 - Maximum Non-Repetitive Peak Forward Surge Current
Uni-Directional Only

»Package Dimensions



SMB						
Dimension	Inches			Millimeters		
	MIN	NOM	MAX	MIN	NOM	MAX
A	0.134	0.144	0.155	3.4	3.67	3.94
B	0.205	0.213	0.22	5.21	5.4	5.59
C	0.075	0.079	0.083	1.9	2	2.1
D	0.169		0.185	4.3		4.7
F	0.006		0.012	0.152		0.305
G	-		0.008	-		0.203
H	0.085	0.091	0.096	2.15	2.3	2.45
L	0.03		0.06	0.76		1.52
X		0.11			2.8	
Y		0.079			2	
Z		0.079			2	

»Marking Information

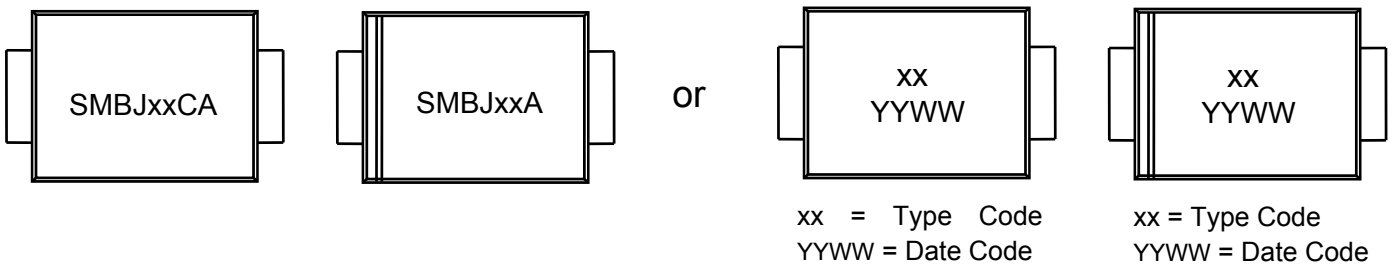

»Soldering Parameters

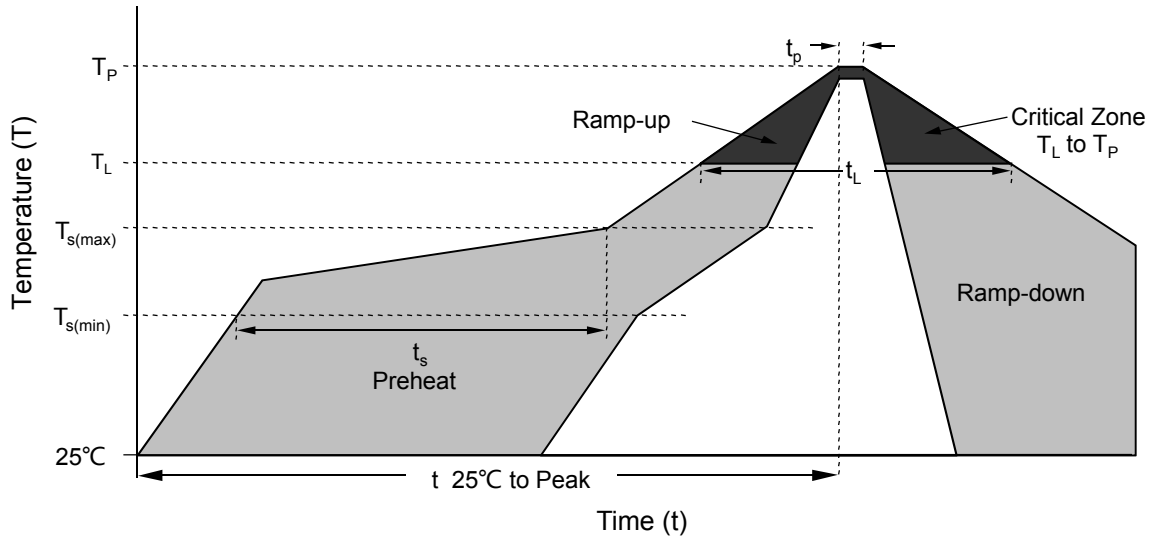

Reflow Condition		Lead-free assembly
Pre Heat	- Temperature Min ($T_{s(min)}$)	150°C
	- Temperature Max ($T_{s(max)}$)	200°C
	- Time (min to max) (t_s)	60 – 180 secs
Average ramp up rate (Liquidus Temp (T_L) to peak)		3°C/second max
$T_{s(max)}$ to T_L - Ramp-up Rate		3°C/second max
Reflow	- Temperature (T_L) (Liquidus)	217°C
	- Time (t_L)	60 – 150 secs
Peak Temperature (T_P)		260 ^{+0/-5} °C
Time within 5°C of actual peak Temperature (t_p)		20 – 40 secs
Ramp-down Rate		6°C/second max
Time 25°C to peak Temperature (t)		8 minutes Max.
Do not exceed		260°C

»Tape and Reel Specification

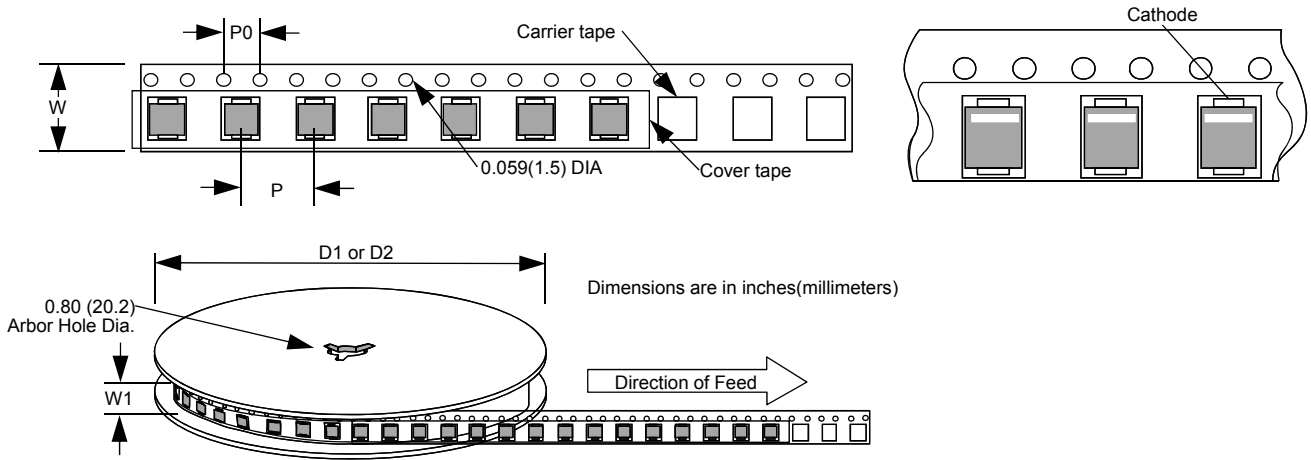

Dimension	Inches			Millimeters		
	MIN	NOM	MAX	MIN	NOM	MAX
P		0.315			8	
P0		0.157			4	
W		0.472			12	
W1		0.492			12.5	
D1		7			177.8	
D2		13			330.2	