



LAN89218

High-Performance Single-Chip 10/100 Ethernet Controller for Automotive Applications

PRODUCT FEATURES

Datasheet

Highlights

- Designed and tested for automotive grade applications
- Integrated 10/100 MAC, PHY with HP Auto-MDIX support
- Interfaces to most 32-bit and 16-bit embedded CPU's
- Integrated checksum offload engine
- Efficient architecture with low CPU overhead
- AEC-Q100 compliant
 - Parts are tested to meet or exceed the requirements of the AEC-Q100 automotive qualification standards

Applications

- Diagnostic interface (for dealership service bay)
- Fast software download interface (e.g. OBD connector)
- Gateway service interface (dealership, aftermarket repair shop)
- In-vehicle engineering development interface
- Vehicle manufacturing test interface (production plant assembly line)
- Legislated inspections (emissions check, safety inspections)

Features

- Non-PCI Ethernet controller for high performance applications
 - 32-bit interface with fast bus cycle times
 - Burst-mode read support
- Single chip Ethernet controller
 - Fully compliant with IEEE 802.3/802.3u standards
 - Integrated Ethernet MAC and PHY
 - 10BASE-T and 100BASE-TX support
 - Full- and Half-duplex support
 - Full-duplex flow control
 - Backpressure for half-duplex flow control

- High-performance host bus interface
 - Simple, SRAM-like interface interfaces to most embedded CPU's or SoC's
 - 32 or 16-bit data bus
 - 16 kbyte FIFO with flexible TX/RX allocation
 - One configurable host interrupt
- Minimizes CPU overhead
 - Supports Slave-DMA
- Supports reduced power modes
 - Numerous power management modes
 - Wake on LAN
 - Magic packet wakeup
 - Wakeup indicator event signal
 - Link status change
- Eliminates dropped packets
 - Internal buffer memory can store over 200 packets
 - Automatic PAUSE and back-pressure flow control
- Flexible address filtering modes
 - One 48-bit perfect address
 - 64 hash filtered multicast addresses
 - Pass all multicast
 - Promiscuous mode
 - Inverse filtering
 - Pass all incoming with status report
 - Disable reception of broadcast packets
- Integrated 1.8 V regulator
- Optional EEPROM interface
- Mixed endian support
- General purpose timer
- Support for 3 status LEDs multiplexed with programmable GPIO signals
- Single 3.3 V Power Supply with 5.0 V tolerant I/O
- Low profile 100-pin TQFP, RoHS-compliant package
- -40°C to +85°C Automotive Grade Temp. Support

High-Performance Single-Chip 10/100 Ethernet Controller for Automotive Applications

Datasheet

Order Numbers:

LAN89218AQ-B (Tray) FOR 100-PIN, TQFP, ROHS-COMPLIANT PACKAGE WITH E3 FINISH (MATTE TIN)
LAN89218AQR-B (Tape & Reel) FOR 100-PIN, TQFP, ROHS-COMPLIANT PACKAGE WITH E3 FINISH (MATTE TIN)

Table of Contents

Chapter 1 General Description	10
1.1 Compatibility with LAN911x and LAN921x Device Families	11
1.2 Internal Block Overview	12
1.3 10/100 Ethernet PHY	12
1.4 10/100 Ethernet MAC	13
1.5 Receive and Transmit FIFOs	13
1.6 Host Bus Interface (SRAM Interface)	13
1.7 Interrupt Controller	13
1.8 GPIO Interface	14
1.9 Serial EEPROM Interface	14
1.10 Power Management Controls	14
1.11 General Purpose Timer	14
Chapter 2 Pin Description and Configuration	15
2.1 Pin List	16
2.2 Buffer Types	23
Chapter 3 Functional Description	24
3.1 10/100 Ethernet MAC	24
3.2 Flow Control	25
3.2.1 Full-Duplex Flow Control	25
3.2.2 Half-Duplex Flow Control (Backpressure)	25
3.2.3 Virtual Local Area Network (VLAN) Support	26
3.3 Address Filtering Functional Description	27
3.4 Filtering Modes	28
3.4.1 Perfect Filtering	28
3.4.2 Hash Only Filtering	28
3.5 Wake-up Frame Detection	29
3.5.1 Magic Packet Detection	31
3.6 Checksum Offload Engines (COE)	32
3.6.1 Receive Checksum Offload Engine (RXCOE)	32
3.6.2 Transmit Checksum Offload Engine (TXCOE)	35
3.7 Host Bus Operations	37
3.7.1 32-bit vs. 16-bit Host Bus Width Operation	37
3.7.2 16-bit Bus Writes	37
3.7.3 16-bit Bus Reads	37
3.7.4 Mixed Endian Support	37
3.7.5 Word Swap Function	38
3.8 General Purpose Timer (GP Timer)	41
3.9 EEPROM Interface	42
3.9.1 MAC Address Auto-Load	42
3.9.2 EEPROM Host Operations	42
3.10 Power Management	48
3.10.1 System Description	48
3.10.2 Functional Description	48
3.10.3 Internal PHY Power-Down modes	51
3.11 Detailed Reset Description	52
3.11.1 Power-On Reset (POR)	53

3.11.2 Hardware Reset Input (nRESET)	53
3.11.3 Soft Reset (SRST)	53
3.11.4 PHY Reset Timing	54
3.12 TX Data Path Operation	54
3.12.1 TX Buffer Format	56
3.12.2 TX Command Format	57
3.12.3 TX Data Format	59
3.12.4 TX Status Format	60
3.12.5 Calculating Actual TX Data FIFO Usage	61
3.12.6 Transmit Examples	61
3.12.7 Transmitter Errors	66
3.12.8 Stopping and Starting the Transmitter	66
3.13 RX Data Path Operation	66
3.13.1 RX Slave PIO Operation	67
3.13.2 RX Packet Format	69
3.13.3 RX Status Format	70
3.13.4 Stopping and Starting the Receiver	71
3.13.5 Receiver Errors	71
<hr/>	
Chapter 4 Internal Ethernet PHY	72
4.1 Top Level Functional Description	72
4.2 100Base-TX Transmit	72
4.2.1 4B/5B Encoding	72
4.2.2 Scrambling	74
4.2.3 NRZI and MLT3 Encoding	74
4.2.4 100M Transmit Driver	74
4.2.5 100M Phase Lock Loop (PLL)	75
4.3 100Base-TX Receive	75
4.3.1 100M Receive Input	75
4.3.2 Equalizer, Baseline Wander Correction and Clock and Data Recovery	75
4.3.3 NRZI and MLT-3 Decoding	76
4.3.4 Descrambling	76
4.3.5 Alignment	76
4.3.6 5B/4B Decoding	76
4.4 10Base-T Transmit	76
4.4.1 10M Transmit Data Across the Internal MII Bus	77
4.4.2 Manchester Encoding	77
4.4.3 10M Transmit Drivers	77
4.5 10Base-T Receive	77
4.5.1 10M Receive Input and Squelch	77
4.5.2 Manchester Decoding	77
4.5.3 Jabber Detection	78
4.6 Auto-Negotiation	78
4.7 Parallel Detection	79
4.7.1 Re-starting Auto-Negotiation	79
4.7.2 Disabling Auto-Negotiation	80
4.7.3 Half vs. Full-Duplex	80
4.8 HP Auto-MDIX	81
<hr/>	
Chapter 5 Register Description	82
5.1 Register Nomenclature and Access Attributes	83
5.2 RX and TX FIFO Ports	83

5.2.1	RX FIFO Ports	83
5.2.2	TX FIFO Ports	84
5.3	System Control and Status Registers	84
5.3.1	ID_REV—Chip ID and Revision	85
5.3.2	IRQ_CFG—Interrupt Configuration Register	86
5.3.3	INT_STS—Interrupt Status Register	87
5.3.4	INT_EN—Interrupt Enable Register	89
5.3.5	BYTE_TEST—Byte Order Test Register	90
5.3.6	FIFO_INT—FIFO Level Interrupts	90
5.3.7	RX_CFG—Receive Configuration Register	91
5.3.8	TX_CFG—Transmit Configuration Register	92
5.3.9	HW_CFG—Hardware Configuration Register	93
5.3.10	RX_DP_CTRL—Receive Datapath Control Register	95
5.3.11	RX_FIFO_INF—Receive FIFO Information Register	96
5.3.12	TX_FIFO_INF—Transmit FIFO Information Register	96
5.3.13	PMT_CTRL—Power Management Control Register	96
5.3.14	GPIO_CFG—General Purpose IO Configuration Register	99
5.3.15	GPT_CFG—General Purpose Timer Configuration Register	101
5.3.16	GPT_CNT—General Purpose Timer Current Count Register	101
5.3.17	WORD_SWAP—Word Swap Control	102
5.3.18	FREE_RUN—Free-Run 25MHz Counter	102
5.3.19	RX_DROP—Receiver Dropped Frames Counter	103
5.3.20	MAC_CSR_CMD – MAC CSR Synchronizer Command Register	103
5.3.21	MAC_CSR_DATA – MAC CSR Synchronizer Data Register	104
5.3.22	AFC_CFG – Automatic Flow Control Configuration Register	105
5.3.23	E2P_CMD – EEPROM Command Register	107
5.3.24	E2P_DATA – EEPROM Data Register	109
5.4	MAC Control and Status Registers	110
5.4.1	MAC_CR—MAC Control Register	111
5.4.2	ADDRH—MAC Address High Register	114
5.4.3	ADDRL—MAC Address Low Register	115
5.4.4	HASHH—Multicast Hash Table High Register	116
5.4.5	HASHL—Multicast Hash Table Low Register	116
5.4.6	MII_ACC—MII Access Register	117
5.4.7	MII_DATA—MII Data Register	117
5.4.8	FLOW—Flow Control Register	118
5.4.9	VLAN1—VLAN1 Tag Register	119
5.4.10	VLAN2—VLAN2 Tag Register	119
5.4.11	WUFF—Wakeup Frame Filter	120
5.4.12	WUCSR—Wake-up Control and Status Register	121
5.4.13	COE_CR—Checksum Offload Engine Control Register	122
5.5	PHY Registers	123
5.5.1	Basic Control Register	124
5.5.2	Basic Status Register	125
5.5.3	PHY Identifier 1	125
5.5.4	PHY Identifier 2	126
5.5.5	Auto-negotiation Advertisement	126
5.5.6	Auto-negotiation Link Partner Ability	127
5.5.7	Auto-negotiation Expansion	128
5.5.8	Mode Control/Status	128
5.5.9	Special Modes	129
5.5.10	Special Control/Status Indications	130

5.5.11 Interrupt Source Flag	131
5.5.12 Interrupt Mask	131
5.5.13 PHY Special Control/Status	132
<hr/>	
Chapter 6 Timing Diagrams	133
6.1 Host Interface Timing	133
6.1.1 Special Restrictions on Back-to-Back Write/Read Cycles	133
6.1.2 Special Restrictions on Back-to-Back Read Cycles	135
6.2 PIO Reads	136
6.3 PIO Burst Reads	137
6.4 RX Data FIFO Direct PIO Reads	138
6.5 RX Data FIFO Direct PIO Burst Reads	139
6.6 PIO Writes	141
6.7 TX Data FIFO Direct PIO Writes	142
6.8 nRESET Timing	143
6.9 EEPROM Timing	144
<hr/>	
Chapter 7 Operational Characteristics	145
7.1 Absolute Maximum Ratings*	145
7.2 Operating Conditions**	145
7.3 Package Thermal Specifications	145
7.4 Power Consumption (Device Only)	146
7.5 Power Consumption (Device and System Components)	147
7.6 DC Electrical Specifications	148
7.7 Clock Circuit	151
<hr/>	
Chapter 8 Package Outline	152
8.1 100-TQFP Package	152
<hr/>	
Chapter 9 Revision History	153

List of Figures

Figure 1.1	System Block Diagram	11
Figure 1.2	Internal Block Diagram	12
Figure 2.1	Pin Configuration (Top View)	15
Figure 3.1	VLAN Frame	26
Figure 3.2	RXCoe Checksum Calculation	32
Figure 3.3	Type II Ethernet Frame	33
Figure 3.4	Ethernet Frame with VLAN Tag	33
Figure 3.5	Ethernet Frame with Length Field and SNAP Header	33
Figure 3.6	Ethernet Frame with VLAN Tag and SNAP Header	34
Figure 3.7	Ethernet Frame with multiple VLAN Tags and SNAP Header	34
Figure 3.8	Host Data Path Diagram	38
Figure 3.9	32-bit Byte Ordering	39
Figure 3.10	16-Bit Byte Ordering	40
Figure 3.11	EEPROM Access Flow Diagram	43
Figure 3.12	EEPROM ERASE Cycle	44
Figure 3.13	EEPROM ERAL Cycle	44
Figure 3.14	EEPROM EWDS Cycle	45
Figure 3.15	EEPROM EWEN Cycle	45
Figure 3.16	EEPROM READ Cycle	46
Figure 3.17	EEPROM WRITE Cycle	46
Figure 3.18	EEPROM WRAL Cycle	46
Figure 3.19	PME and PME_INT Signal Generation	51
Figure 3.20	Simplified Host TX Flow Diagram	55
Figure 3.21	TX Buffer Format	56
Figure 3.22	TX Example 1	62
Figure 3.23	TX Example 2	63
Figure 3.24	TX Example 3	65
Figure 3.25	Host Receive Routine Using Interrupts	67
Figure 3.26	Host Receive Routine with Polling	67
Figure 3.27	RX Packet Format	69
Figure 3.28	RX Packet Format with RX Checksum	69
Figure 4.1	100Base-TX Data Path	72
Figure 4.2	Receive Data Path	75
Figure 4.3	Direct Cable Connection vs. Cross-over Cable Connection	81
Figure 5.1	Memory Map	82
Figure 5.2	Example ADDR_L, ADDR_H and EEPROM Setup	115
Figure 6.1	PIO Read Cycle Timing	136
Figure 6.2	PIO Burst Read Cycle Timing	137
Figure 6.3	RX Data FIFO Direct PIO Read Cycle Timing	138
Figure 6.4	RX Data FIFO Direct PIO Burst Read Cycle Timing	139
Figure 6.5	PIO Write Cycle Timing	141
Figure 6.6	TX Data FIFO Direct PIO Write Timing	142
Figure 6.7	nRESET Reset Pin Timing	143
Figure 6.8	EEPROM Timing	144
Figure 8.1	100-Pin TQFP Package Definition	152

List of Tables

Table 2.1	Host Bus Interface Signals	16
Table 2.2	LAN Interface Signals	17
Table 2.3	Serial EEPROM Interface Signals	18
Table 2.4	System and Power Signals	19
Table 2.5	Default Ethernet Settings	21
Table 2.6	100-TQFP Package Pin Assignments	22
Table 2.7	Buffer Types	23
Table 3.1	Address Filtering Modes	27
Table 3.2	Wake-Up Frame Filter Register Structure	30
Table 3.3	Filter i Byte Mask Bit Definitions	30
Table 3.4	Filter i Command Bit Definitions	30
Table 3.5	Filter i Offset Bit Definitions	31
Table 3.6	Filter i CRC-16 Bit Definitions	31
Table 3.7	TX Checksum Preamble	36
Table 3.8	32-Bit Endian Ordering Logic Operation	41
Table 3.9	16-Bit Endian Ordering Logic Operation	41
Table 3.10	Required EECLK Cycles	47
Table 3.11	Power Management States	50
Table 3.12	Reset Sources and Affected Circuitry	52
Table 3.13	TX Command 'A' Format	57
Table 3.14	TX Command 'B' Format	58
Table 3.15	TX DATA Start Offset	59
Table 4.1	4B/5B Code Table	73
Table 4.2	CRS Behavior	80
Table 5.1	Direct Address Register Map	84
Table 5.2	RX Alignment Bit Definitions	92
Table 5.3	Valid TX/RX FIFO Allocations	94
Table 5.4	EEPROM Enable Bit Definitions	100
Table 5.5	Backpressure Duration Bit Mapping	106
Table 5.6	MAC CSR Register Map	110
Table 5.7	ADDRL, ADDRH and EEPROM Byte Ordering	115
Table 5.8	LAN89218 PHY Control and Status Register	123
Table 5.9	MODE Control	129
Table 6.1	Read After Write Timing Rules	134
Table 6.2	Read After Read Timing Rules	135
Table 6.3	PIO Read Timing	136
Table 6.4	PIO Burst Read Timing	137
Table 6.5	RX Data FIFO Direct PIO Read Timing	138
Table 6.6	RX Data FIFO Direct PIO Burst Read Cycle Timing	140
Table 6.7	PIO Write Cycle Timing	141
Table 6.8	TX Data FIFO Direct PIO Write Timing	142
Table 6.9	nRESET Reset Pin Timing Values	143
Table 6.10	EEPROM Timing Values	144
Table 7.1	Package Thermal Parameters	145
Table 7.2	Power Consumption Device Only	146
Table 7.3	Power Consumption Device and System Components	147
Table 7.4	Supply Current Characteristics	148
Table 7.5	I/O Buffer Characteristics	148
Table 7.6	100BASE-TX Transceiver Characteristics	150
Table 7.7	10BASE-T Transceiver Characteristics	150

Table 7.8	LAN89218 Crystal Specifications	151
Table 8.1	100-Pin TQFP Package Parameters	152
Table 9.1	Customer Revision History	153

Chapter 1 General Description

The LAN89218 is a full-featured, single-chip 10/100 Ethernet controller that has been designed to provide the highest performance possible for 32/16-bit applications. The LAN89218 includes an integrated Ethernet MAC and PHY with a high-performance SRAM-like slave interface. The simple, yet highly functional host bus interface provides a glue-less connection to most common 16-bit and 32-bit microprocessors and microcontrollers. The integrated checksum offload engines enable the automatic generation of the 16-bit checksum for received and transmitted Ethernet frames, offloading the task from the CPU. The LAN89218 also includes large transmit and receive data FIFOs with a high-speed host bus interface to accommodate high bandwidth, high latency applications. In addition, the LAN89218 memory buffer architecture allows highly efficient use of memory resources by optimizing packet granularity.

Applications

The LAN89218 is well suited for many high performance automotive applications, including:

- Diagnostic interface (for dealership service bay)
- Fast software download interface (e.g. OBD connector)
- Gateway service interface (dealership, aftermarket repair shop)
- In-vehicle engineering development interface
- Vehicle manufacturing test interface (production plant assembly line)
- Legislated inspections (emissions check, safety inspections)

The LAN89218 also supports features which reduce or eliminate packet loss. Its internal 16-kByte SRAM can hold over 200 received packets. If the receive FIFO gets too full, the LAN89218 can automatically generate flow control packets to the remote node, or assert back-pressure on the remote node by generating network collisions.

The LAN89218 supports numerous power management and wakeup features. The LAN89218 can be placed in a reduced power mode and can be programmed to issue an external wake signal via several methods, including “Magic Packet”, “Wake on LAN” and “Link Status Change”. This signal is ideal for triggering system power-up using remote Ethernet wakeup events. The device can be removed from the low power state via a host processor command.

The LAN89218 integrated 10/100 MAC/PHY controller performs the function of translating parallel data from a host controller into Ethernet packets. The LAN89218 Ethernet MAC/PHY controller is designed and optimized to function in an embedded environment. All communication is performed with programmed I/O transactions using the simple SRAM-like host interface bus.

The figure below summarizes a system configuration of the LAN89218 in a typical embedded environment.

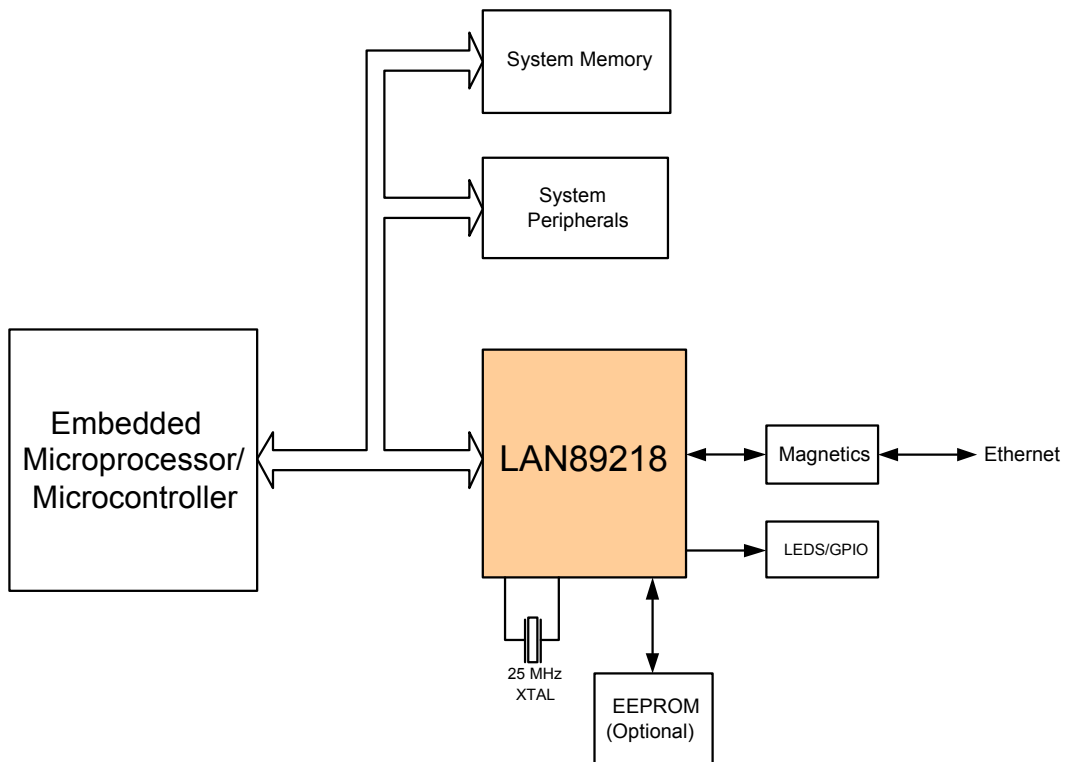

Figure 1.1 System Block Diagram

1.1 Compatibility with LAN911x and LAN921x Device Families

The LAN89218 is driver-, register-, and footprint-compatible with previous generation LAN911x and LAN921x device families. Drivers written for these products will work with the LAN89218. However, when migrating from the LAN911x family, in order to support HP Auto-MDIX, other components such as the magnetics and the passive components around the magnetics need to change. Supporting these changes does require a minor PCB change. Refer to the Microchip website for additional application details.

1.2 Internal Block Overview

This section provides an overview of the major functional blocks of the LAN89218, as shown in Figure 1.2, "Internal Block Diagram".

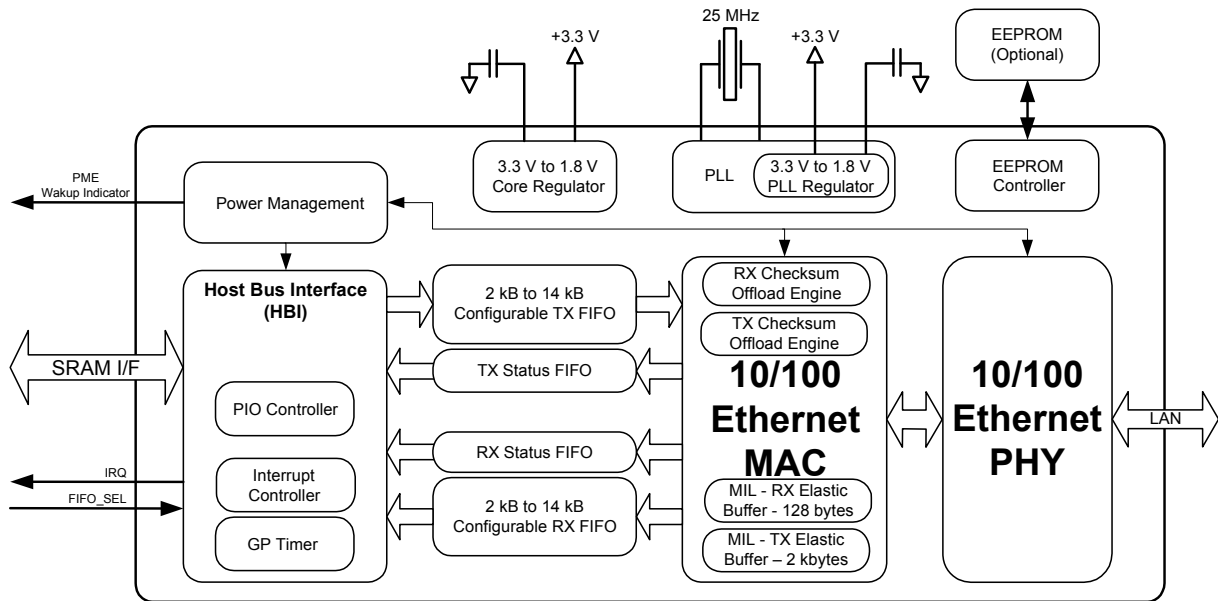

Figure 1.2 Internal Block Diagram

1.3 10/100 Ethernet PHY

The LAN89218 integrates an IEEE 802.3 physical layer for twisted pair Ethernet applications. The PHY can be configured for either 100 Mbps (100BASE-TX) or 10 Mbps (10BASE-T) Ethernet operation in either full or half duplex configurations. The PHY block supports HP Auto-MDIX and auto-negotiation.

Minimal external components are required for the utilization of the Integrated PHY.

1.4 10/100 Ethernet MAC

The transmit and receive data paths are separate within the MAC allowing for the highest performance possible, especially in full duplex mode. The data paths connect to the PIO interface via separate busses to increase performance. Payload data as well as transmit and receive status are passed on these busses. A third internal bus is used to access the MAC's Control and Status Registers (CSR's). This bus is accessible from the host through the PIO interface function.

On the backend, the MAC interfaces with the internal 10/100 PHY through a MII (Media Independent Interface) port internal to the LAN89218. The MAC CSR's also provide a mechanism for accessing the PHY's internal registers through the internal SMI (Serial Management Interface) bus.

The MAC Interface Layer (MIL), within the MAC, contains a 2 kByte transmit and a 128 Byte receive FIFO which is separate from the TX and RX FIFOs. The FIFOs within the MAC are not directly accessible from the host interface. The differentiation between the TX/RX FIFO memory buffers and the MAC buffers is that when the transmit or receive packets are in the MAC buffers, the host no longer can control or access the TX or RX data. The MAC buffers (both TX and RX) are in effect the working buffers of the Ethernet MAC logic. In the case of reception, the data must be moved first to the RX FIFOs for the host to access the data. For TX operations, the MIL operates in store-and-forward mode and will queue an entire frame before beginning transmission.

1.5 Receive and Transmit FIFOs

The Receive and Transmit FIFOs allow increased packet buffer storage to the MAC. The FIFOs are a conduit between the host interface and the MAC through which all transmitted and received data and status information is passed. Deep FIFOs allow a high degree of latency tolerance relative to the various transport and OS software stacks thus reducing or minimizing overrun conditions. Like the MAC, the FIFOs have separate receive and transmit data paths. In addition, the RX and TX FIFOs are configurable in size, allowing increased flexibility.

1.6 Host Bus Interface (SRAM Interface)

The host bus interface provides a FIFO interface for the transmit and receive data paths, as well as an interface for the LAN89218 Control and Status Registers (CSR's).

The host bus interface is the primary bus for connection to the embedded host system. This interface models an asynchronous SRAM. TX FIFO, RX FIFO, and CSR's are accessed through this interface. Programmed I/O transactions are supported.

The LAN89218 host bus interface supports 32-bit and 16-bit bus transfers. Internally, all data paths are 32-bits wide. The LAN89218 can be interfaced to either Big-Endian or Little-Endian processors and includes mixed endian support for FIFO accesses.

1.7 Interrupt Controller

The LAN89218 supports a single programmable interrupt. The programmable nature of this interrupt allows the user the ability to optimize performance dependent upon the application requirement. Both the polarity and buffer type of the interrupt pin are configurable for the external interrupt processing. The interrupt line can be configured as an open-drain output to facilitate the sharing of interrupts with other devices. In addition, a programmable interrupt de-assertion interval is provided.

1.8 GPIO Interface

A 3-bit GPIO and 2-bit GPO (Multiplexed on the EEPROM and LED Pins) interface is included in the LAN89218. It is accessible through the host bus interface via the CSRs. The GPIO signals can function as inputs, push-pull outputs and open drain outputs. The GPIO's (GPO's are not configurable) can also be configured to trigger interrupts with programmable polarity.

1.9 Serial EEPROM Interface

A serial EEPROM interface is included in the LAN89218. The serial EEPROM is optional and can be programmed with the LAN89218 MAC address. The LAN89218 can optionally load the MAC address automatically after power-on reset, hardware reset, or soft reset.

1.10 Power Management Controls

The LAN89218 supports comprehensive array of power management modes to allow use in power sensitive applications. Wake on LAN, Link Status Change and Magic Packet detection are supported by the LAN89218. An external PME (Power Management Event) interrupt is provided to indicate detection of a wakeup event.

1.11 General Purpose Timer

The general-purpose timer has no dedicated function within the LAN89218 and may be programmed to issue a timed interrupt.

Chapter 2 Pin Description and Configuration

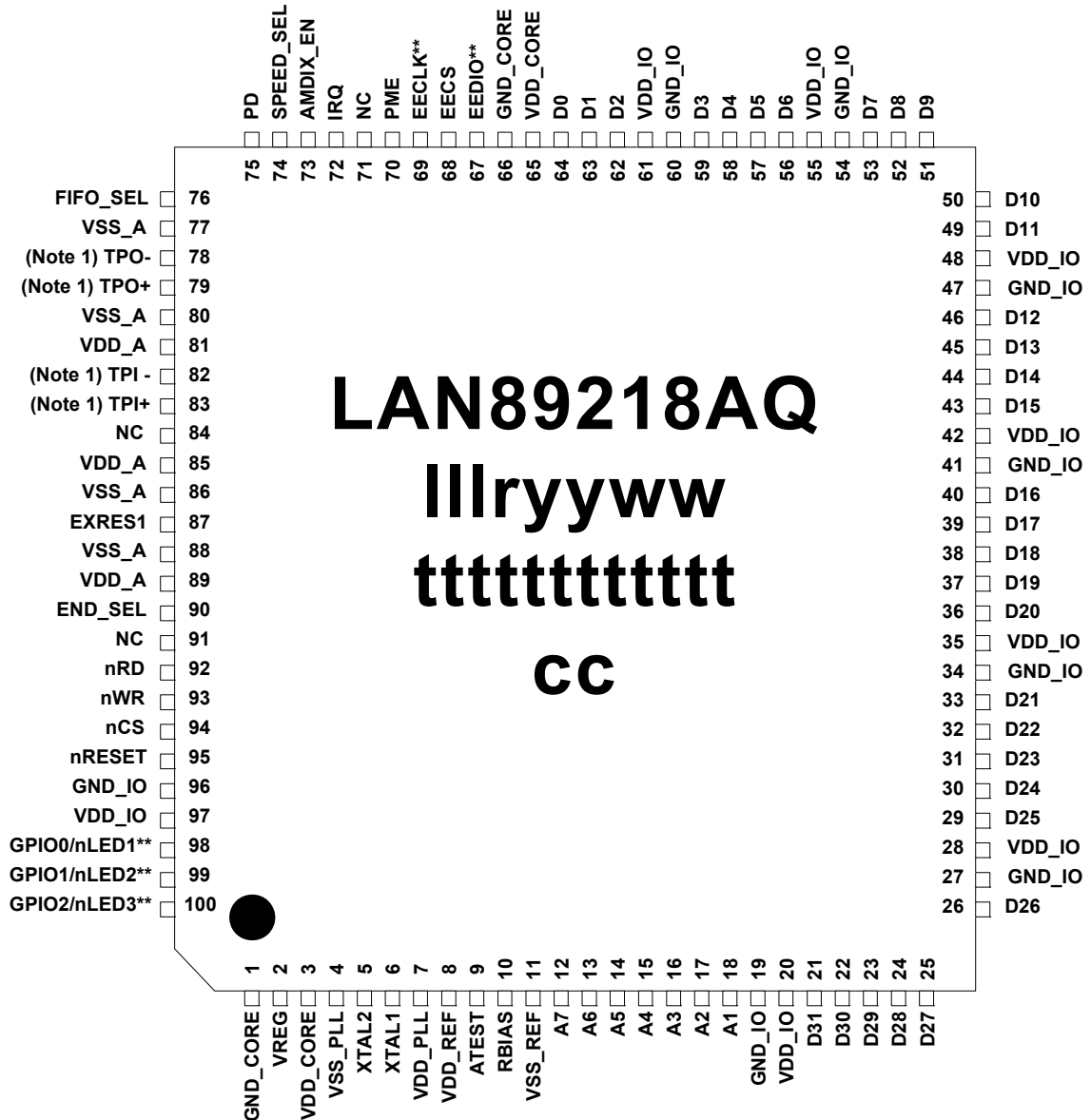

**DENOTES A MULTIFUNCTION PIN

Note 1: When HP Auto-MDIX is activated, the TPO+/- pins function as TPI+/- and vice-versa.

Figure 2.1 Pin Configuration (Top View)

The package designators are:

- ll - Lot Sequence Code (optional)
- r - Chip Revision Number
- yy - last two digits of Assembly Year
- ww - Assembly Work Week
- tttttttttt - Tracking Number (up to 12 characters)
- cc - Country of Original Abbreviation (Optional - up to 2 characters)

2.1 Pin List

Table 2.1 Host Bus Interface Signals

NAME	SYMBOL	BUFFER TYPE	# PINS	DESCRIPTION
Host Data High	D[31:16]	I/O8 (PD)	16	Bi-directional data port. Note that Pull-down's are disabled in 32-bit mode.
Host Data Low	D[15:0]	I/O8	16	Bi-directional data port.
Host Address	A[7:1]	IS	7	7-bit Address Port. Used to select Internal CSR's and TX and RX FIFOs.
Read Strobe	nRD	IS	1	Active low strobe to indicate a read cycle.
Write Strobe	nWR	IS	1	Active low strobe to indicate a write cycle. This signal, qualified with nCS, is also used to wakeup the LAN89218 when it is in a reduced power state.
Chip Select	nCS	IS	1	Active low signal used to qualify read and write operations. This signal qualified with nWR is also used to wakeup the LAN89218 when it is in a reduced power state.
Interrupt Request	IRQ	O8/OD8	1	Programmable Interrupt request. Programmable polarity, source and buffer types.
FIFO Select	FIFO_SEL	IS	1	When driven high all accesses to the LAN89218 are to the RX or TX Data FIFOs. In this mode, the A[7:3] upper address inputs are ignored.
Endianess Select	END_SEL	IS (PD)	1	<p>Endianess Select: When low, all host bus accesses follow little endian byte ordering. When high, all accesses follow big endian byte ordering.</p> <p>This signal is qualified with nCS and nRD for read operations, and is qualified with nCS and nWR for write operations. This signal has the same timing characteristics as the address inputs.</p> <p>Note: This signal is pulled low internally and may be left unconnected or connected to ground for compatibility with earlier devices.</p>

Table 2.2 LAN Interface Signals

NAME	SYMBOL	BUFFER TYPE	NUM PINS	DESCRIPTION
TPO+	TPO+	AIO	1	Transmit Positive Output (normal) Receive Positive Input (reversed)
TPO-	TPO-	AIO	1	Transmit Negative Output (normal) Receive Negative Input (reversed)
TPI+	TPI+	AIO	1	Receive Positive Input (normal) Transmit Positive Input (reversed)
TPI-	TPI-	AIO	1	Receive Negative Input (normal) Transmit Negative Output (reversed)
PHY External Bias Resistor	EXRES1	AI	1	Must be connected to ground through a 12.4 kΩ 1% resistor.

Note: The pin names for the twisted pair pins shown above apply to a normal connection. If HP Auto-MDIX is enabled and a reverse connection is detected, or a reverse connection is manually selected, the input pins become outputs, and vice-versa, as indicated in the descriptions.

Table 2.3 Serial EEPROM Interface Signals

NAME	SYMBOL	BUFFER TYPE	NUM PINS	DESCRIPTION
EEPROM Data, GPO3, TX_EN, TX_CLK, D32/nD16	EEDIO/GPO3/ TX_EN/TX_CLK (D32/nD16)	I/O8	1	<p>EEPROM Data: This bi-directional pin can be connected to a serial EEPROM DIO. This is optional.</p> <p>General Purpose Output 3: This pin can also function as a general purpose output, or it can be configured to monitor the TX_EN or TX_CLK signals on the internal MII port. When configured as a GPO signal, or as a TX_EN/TX_CLK monitor, the EECS pin is deasserted so as to never unintentionally access the serial EEPROM. This signal cannot function as a general-purpose input.</p> <p>Data Bus Width Select: This signal also functions as a configuration input on power-up and is used to select the host bus data width. Upon deassertion of reset, the value of the input is latched. When high, a 32-bit data bus is utilized. When low, a 16-bit interface is utilized.</p>
EEPROM Chip Select	EECS	O8	1	Serial EEPROM chip select.
EEPROM Clock, GPO4 RX_DV, RX_CLK	EECLK/GPO4/ RX_DV/RX_CLK	O8	1	<p>EEPROM Clock: Serial EEPROM Clock pin.</p> <p>General Purpose Output 4: This pin can also function as a general-purpose output, or it can be configured to monitor the RX_DV or RX_CLK signals on the internal MII port. When configured as a GPO signal, or as an RX_DV/RX_CLK monitor, the EECS pin is deasserted so as to never unintentionally access the serial EEPROM. This signal cannot function as a general-purpose input.</p> <p>Note: When the EEPROM interface is not used, the EECLK pin must be left unconnected.</p> <p>Note: This pin must not be pulled low by an external resistor or driven low externally under any conditions.</p>

Table 2.4 System and Power Signals

NAME	SYMBOL	BUFFER TYPE	NUM PINS	DESCRIPTION
Crystal 1, Clock In	XTAL1/CLKIN	ICLK	1	External 25 MHz Crystal Input. This pin can also be connected to single-ended TTL oscillator (CLKIN). If this method is implemented, XTAL2 should be left unconnected.
Crystal 2	XTAL2	OCLK	1	External 25 MHz Crystal output.
Reset	nRESET	IS (PU)	1	Active-low reset input. Resets all logic and registers within the LAN89218. This signal is pulled high with a weak internal pull-up resistor. Note: The LAN89218 must always be read at least once after power-up, reset, or upon return from a power-saving state or write operations will not function. See Section 3.11, "Detailed Reset Description," on page 52 for additional information
Wakeup Indicator	PME	O8/OD8	1	When programmed to do so, is asserted when the LAN89218 detects a wake event and is requesting the system to wake up from the associated sleep state. The polarity and buffer type of this signal is programmable. Note: Detection of a Power Management Event, and assertion of the PME signal will not wakeup the LAN89218. The LAN89218 will only wake up when it detects a host write cycle (assertion of nCS and nWR). Although any write to the LAN89218, regardless of the data written, will wake-up the device when it is in a power-saving mode, it is required that the BYTE_TEST register be used for this purpose.
Auto-MDIX Enable	AMDIX_EN	I (PD)	1	Enables Auto-MDIX. Pull high to enable Auto-MDIX, pull low or leave unconnected to disable Auto-MDIX.
10/100 Selector	SPEED_SEL	I (PU)	1	This signal functions as a configuration input on power-up and is used to select the default Ethernet settings. Upon deassertion of reset, the value of the input is latched. This signal functions as shown in Table 2.5, "Default Ethernet Settings," below.
No Connect	NC		3	No Connect. These pins must be left open.
Pull-Down (Reserved)	PD	I (PD)	1	Reserved for internal purposes only. This pin should be pulled low through an external pull-down resistor or left unconnected.

Table 2.4 System and Power Signals (continued)

NAME	SYMBOL	BUFFER TYPE	NUM PINS	DESCRIPTION
General Purpose I/O data, nLED1 (Speed Indicator), nLED2 (Link & Activity Indicator), nLED3 (Full-Duplex Indicator).	GPIO[2:0]/nLED[3:1]	IS/O12/OD12	3	<p>General Purpose I/O data: These three general-purpose signals are fully programmable as either push-pull output, open-drain output or input by writing the GPIO_CFG configuration register in the CSR's. They are also multiplexed as GP LED connections. GPIO signals are Schmitt-triggered inputs. When configured as LED outputs these signals are open-drain and the input buffers are disabled.</p> <p>nLED1 (Speed Indicator). This signal is driven low when the operating speed is 100 Mbps. During auto-negotiation, when the cable is disconnected, and during 10 Mbps operation, this signal is driven high.</p> <p>nLED2 (Link & Activity Indicator). This signal is driven low (LED on) when the LAN89218 detects a valid link. This signal is pulsed high (LED off) for 80 ms whenever transmit or receive activity is detected. This signal is then driven low again for a minimum of 80 ms, after which time it will repeat the process if TX or RX activity is detected. Effectively, LED2 is activated solid for a link. When transmit or receive activity is sensed LED2 will flash as an activity indicator.</p> <p>nLED3 (Full-Duplex Indicator). This signal is driven low when the link is operating in full-duplex mode.</p>
RBIAS	RBIAS	AI	1	PLL Bias: Connect to an external 12.0 kΩ 1.0% resistor to ground. Used for the PLL Bias circuit.
Test Pin	ATEST	I	1	This pin must be connected to VDD for normal operation.
Internal Regulator Power	VREG	P	1	3.3 V input for internal voltage regulator
+3.3 V I/O Power	VDD_IO	P	8	+3.3 V I/O logic power supply pins
I/O Ground	GND_IO	P	8	Ground for I/O pins
+3.3 V Analog Power	VDD_A	P	3	+3.3 V analog power supply pins.
Analog Ground	VSS_A	P	4	Ground for analog circuitry
Core Voltage Decoupling	VDD_CORE	P	2	+1.8 V from internal core regulator. Both pins must be connected together externally. Each pin requires a 0.01 μF decoupling capacitor. In addition, pin 3 requires a bulk 10μF capacitor (<2 Ω ESR) in parallel. (Note 2.1)
Core Ground	GND_CORE	P	2	Ground for internal digital logic

Table 2.4 System and Power Signals (continued)

NAME	SYMBOL	BUFFER TYPE	NUM PINS	DESCRIPTION
PLL Power	VDD_PLL	P	1	+1.8 V Power from the internal PLL regulator. This pin must be connected to a 10 μ F capacitor (<2 Ω ESR), in parallel with a 0.01 μ F capacitor to ground. (Note 2.2)
PLL Ground	VSS_PLL	P	1	GND for the PLL
Reference Power	VDD_REF	P	1	Connected to 3.3 V power and used as the reference voltage for the internal PLL
Reference Ground	VSS_REF	P	1	Ground for internal PLL reference voltage

Note 2.1 These pins must not be used to supply power to other external devices.

Note 2.2 This pin must not be used to supply power to other external devices.

Table 2.5 Default Ethernet Settings

DEFAULT ETHERNET SETTINGS			
SPEED_SEL	SPEED	DUPLEX	AUTO NEG.
0	10 Mbps	Half-Duplex	Disabled
1	100 Mbps	Half-Duplex	Enabled

Table 2.6 100-TQFP Package Pin Assignments

PIN NUM	PIN NAME	PIN NUM	PIN NAME	PIN NUM	PIN NAME	PIN NUM	PIN NAME
1	GND_CORE	26	D26	51	D9	76	FIFO_SEL
2	VREG	27	GND_IO	52	D8	77	VSS_A
3	VDD_CORE	28	VDD_IO	53	D7	78	TPO-
4	VSS_PLL	29	D25	54	GND_IO	79	TPO+
5	XTAL2	30	D24	55	VDD_IO	80	VSS_A
6	XTAL1	31	D23	56	D6	81	VDD_A
7	VDD_PLL	32	D22	57	D5	82	TPI-
8	VDD_REF	33	D21	58	D4	83	TPI+
9	ATEST	34	GND_IO	59	D3	84	NC
10	RBIAS	35	VDD_IO	60	GND_IO	85	VDD_A
11	VSS_REF	36	D20	61	VDD_IO	86	VSS_A
12	A7	37	D19	62	D2	87	EXRES1
13	A6	38	D18	63	D1	88	VSS_A
14	A5	39	D17	64	D0	89	VDD_A
15	A4	40	D16	65	VDD_CORE	90	END_SEL
16	A3	41	GND_IO	66	GND_CORE	91	NC
17	A2	42	VDD_IO	67	EEDIO	92	nRD
18	A1	43	D15	68	EECS	93	nWR
19	GND_IO	44	D14	69	EECLK	94	nCS
20	VDD_IO	45	D13	70	PME	95	nRESET
21	D31	46	D12	71	NC	96	GND_IO
22	D30	47	GND_IO	72	IRQ	97	VDD_IO
23	D29	48	VDD_IO	73	AMDIX_EN	98	GPIO0/nLED1
24	D28	49	D11	74	SPEED_SEL	99	GPIO1/nLED2
25	D27	50	D10	75	PD	100	GPIO2/nLED3

2.2 Buffer Types

Table 2.7 Buffer Types

TYPE	DESCRIPTION
I	Input pin
IS	Schmitt triggered Input
O12	Output with 12 mA sink and 12 mA source
OD12	Open-drain output with 12 mA sink
OD8	Open-drain output with 8 mA sink
O8	Output 8 mA symmetrical drive
PU	50 μ A (typical) internal pull-up
PD	50 μ A (typical) internal pull-down
AI	Analog input
AO	Analog output
AIO	Analog bi-directional
ICLK	Crystal oscillator input pin
OCLK	Crystal oscillator output pin

Chapter 3 Functional Description

3.1 10/100 Ethernet MAC

The Ethernet Media Access controller (MAC) incorporates the essential protocol requirements for operating an Ethernet/IEEE 802.3-compliant node and provides an interface between the host subsystem and the internal Ethernet PHY. The MAC can operate in either 100-Mbps or 10-Mbps mode.

The MAC operates in both half-duplex and full-duplex modes. When operating in half-duplex mode, the MAC complies fully with Section 4 of ISO/IEC 8802-3 (ANSI/IEEE standard) and ANSI/IEEE 802.3 standards. When operating in full-duplex mode, the MAC complies with IEEE 802.3x full-duplex operation standard.

The MAC provides programmable enhanced features designed to minimize host supervision, bus utilization, and pre- or post-message processing. These features include the ability to disable retries after a collision, dynamic FCS (Frame Check Sequence) generation on a frame-by-frame basis, automatic pad field insertion and deletion to enforce minimum frame size attributes, layer 3 checksum calculation for transmit and receive operations, and automatic retransmission and detection of collision frames.

The MAC can sustain transmission or reception of minimally-sized back-to-back packets at full line speed with an interpacket gap (IPG) of 9.6 μ s for 10 Mbps and 0.96 μ s for 100 Mbps.

The primary attributes of the MAC Function are:

- Transmit and receive message data encapsulation
- Framing (frame boundary delimitation, frame synchronization)
- Error detection (physical medium transmission errors)
- Media access management
- Medium allocation (collision detection, except in full-duplex operation)
- Contention resolution (collision handling, except in full-duplex operation)
- Flow control during full-duplex mode
- Decoding of control frames (PAUSE command) and disabling the transmitter
- Generation of control frames
- Interface to the internal PHY.
- Checksum offload engine for calculation of layer 3 transmit and receive checksum.

The transmit and receive data paths are separate within the LAN89218 from the MAC to host interface allowing the highest performance, especially in full duplex mode. Payload data as well as transmit and receive status are passed on these busses.

A third internal bus is used to access the MAC's "Control and Status Registers" (CSR's). This bus is also accessible from the host.

On the backend, the MAC interfaces with the 10/100 PHY through an MII (Media Independent Interface) port which is internal to the LAN89218. The MAC CSR's also provide a mechanism for accessing the PHY's internal registers through the internal SMI (Serial Management Interface) bus.

The receive and transmit FIFOs allow increased packet buffer storage to the MAC. The FIFOs are a conduit between the host interface and the MAC through which all transmitted and received data and status information is passed. Deep FIFOs allow a high degree of latency tolerance relative to the various transport and OS software stacks reducing and minimizing overrun conditions. Like the MAC, the FIFOs have separate receive and transmit data paths.

The LAN89218 can store up to 250 Ethernet packets utilizing FIFOs, totaling 16 kbytes, with a packet granularity of 4 bytes. This memory is shared by the RX and TX blocks and is configurable in terms of allocation. This depth of buffer storage minimizes or eliminates receive overruns.

3.2 Flow Control

The LAN89218 Ethernet MAC supports full-duplex flow control using the pause operation and control frame. It also supports half-duplex flow control using back pressure.

3.2.1 Full-Duplex Flow Control

The pause operation inhibits data transmission of data frames for a specified period of time. A Pause operation consists of a frame containing the globally assigned multicast address (01-80-C2-00-00-01), the PAUSE opcode, and a parameter indicating the quantum of slot time (512 bit times) to inhibit data transmissions. The PAUSE parameter may range from 0 to 65,535 slot times. The Ethernet MAC logic, on receiving a frame with the reserved multicast address and PAUSE opcode, inhibits data frame transmissions for the length of time indicated. If a Pause request is received while a transmission is in progress, then the pause will take effect after the transmission is complete. Control frames are received and processed by the MAC and are passed on.

The MAC also transmits control frames (pause command) via both hardware and software control. The software driver requests the MAC to transmit a control frame and gives the value of the PAUSE time to be used in the control frame. The MAC Function constructs a control frame with the appropriate values set in all the different fields (as defined in the 802.3x specification) and transmits the frame to the MII interface. The transmission of the control frame is not affected by the current state of the Pause timer value that is set because of a recently received control frame.

3.2.2 Half-Duplex Flow Control (Backpressure)

In half-duplex mode, back pressure is used for flow control. Whenever the receive buffer/FIFO becomes full or crosses a certain threshold level, the MAC starts sending a Jam signal. The MAC transmit logic enters a state at the end of current transmission (if any), where it waits for the beginning of a received frame. Once a new frame starts, the MAC starts sending the jam signal, which will result in a collision. After sensing the collision, the remote station will back off its transmission. The MAC continues sending the jam to make other stations defer transmission. The MAC only generates this collision-based back pressure when it receives a new frame, in order to avoid any late collisions.

3.2.3 Virtual Local Area Network (VLAN) Support

Virtual Local Area Networks or VLANs, as defined within the IEEE 802.3 standard, provide network administrators one means of grouping nodes within a larger network into broadcast domains. To implement a VLAN, four extra bytes are added to the basic Ethernet packet. As shown in [Figure 3.1, "VLAN Frame"](#), the four bytes are inserted after the Source Address Field and before the Type/Length field. The first two bytes of the VLAN tag identify the tag, and by convention are set to the value 0x8100. The last two bytes identify the specific VLAN associated with the packet; they also provide a priority field.

The LAN89218 supports VLAN-tagged packets. The LAN89218 provides two registers which are used to identify VLAN-tagged packets. One register should normally be set to the conventional VLAN ID of 0x8100. The other register provides a way of identifying VLAN frames tagged with a proprietary (not 0x8100) identifier. If a packet arrives bearing either of these tags in the two bytes succeeding the Source Address field, the controller will recognize the packet as a VLAN-tagged packet. In this case, the controller increases the maximum allowed packet size from 1518 to 1522 bytes (normally the controller filters packets larger than 1518 bytes). This allows the packet to be received, and then processed by host software, or to be transmitted on the network.

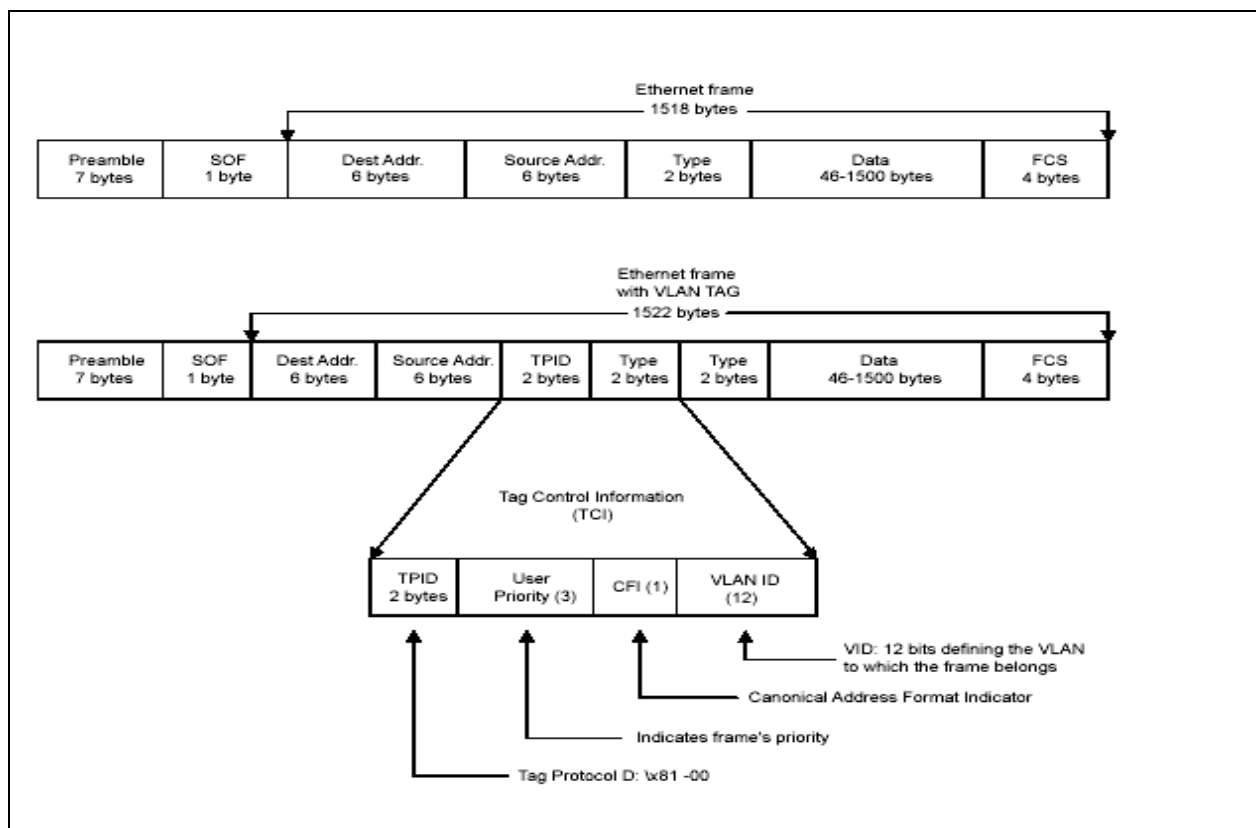

Figure 3.1 VLAN Frame

3.3 Address Filtering Functional Description

The Ethernet address fields of an Ethernet Packet, consists of two 6-byte fields: one for the destination address and one for the source address. The first bit of the destination address signifies whether it is a physical address or a multicast address.

The LAN89218 address check logic filters the frame based on the Ethernet receive filter mode that has been enabled. Filter modes are specified based on the state of the control bits in [Table 3.1, "Address Filtering Modes"](#), which shows the various filtering modes used by the Ethernet MAC Function. These bits are defined in more detail in the "MAC Control Register". Refer to [Section 5.4.1, "MAC_CR—MAC Control Register"](#) for more information on this register.

If the frame fails the filter, the Ethernet MAC function does not receive the packet. The host has the option of accepting or ignoring the packet.

Table 3.1 Address Filtering Modes

MCPAS	PRMS	INVFILT	HO	HPFILT	DESCRIPTION
0	0	0	0	0	MAC address perfect filtering only for all addresses.
0	0	0	0	1	MAC address perfect filtering for physical address and hash filtering for multicast addresses
0	0	0	1	1	Hash Filtering for physical and multicast addresses
0	0	1	0	0	Inverse Filtering
X	1	0	X	X	Promiscuous
1	0	0	0	X	Pass all multicast frames. Frames with physical addresses are perfect-filtered
1	0	0	1	1	Pass all multicast frames. Frames with physical addresses are hash-filtered

3.4 Filtering Modes

3.4.1 Perfect Filtering

This filtering mode passes only incoming frames whose destination address field exactly matches the value programmed into the MAC Address High register and the MAC address low register. The MAC address is formed by the concatenation of the above two registers in the MAC CSR Function.

3.4.2 Hash Only Filtering

This type of filtering checks for incoming Receive packets with either multicast or physical destination addresses, and executes an imperfect address filtering against the hash table.

During imperfect hash filtering, the destination address in the incoming frame is passed through the CRC logic and the upper six bits of the CRC register are used to index the contents of the hash table. The hash table is formed by merging the register's multicast hash table high and multicast hash table low in the MAC CSR Function to form a 64-bit hash table. The most significant bit determines the register to be used (High/Low), while the other five bits determine the bit within the register. A value of 00000 selects Bit 0 of the multicast hash table low register and a value of 11111 selects Bit 31 of the multicast hash table high register.

3.4.2.1 Hash Perfect Filtering

In hash perfect filtering, if the received frame is a physical address, the LAN89218 Packet Filter block perfect-filters the incoming frame's destination field with the value programmed into the MAC Address High register and the MAC Address Low register. If the incoming frame is a multicast frame, however, the LAN89218 packet filter function performs an imperfect address filtering against the hash table.

The imperfect filtering against the hash table is the same imperfect filtering process described in the "Hash Only Filtering" section above.

3.4.2.2 Inverse Filtering

In inverse filtering, the Packet Filter Block accepts incoming frames with a destination address not matching the perfect address (i.e., the value programmed into the MAC Address High register and the MAC Address Low register in the CRC block and rejects frames with destination addresses matching the perfect address.

For all filtering modes, when MCPAS is set, all multicast frames are accepted. When the PRMS bit is set, all frames are accepted regardless of their destination address. This includes all broadcast frames as well.

3.5 Wake-up Frame Detection

Setting the Wake-up Frame Enable bit (WUEN) in the [WUCSR—Wake-up Control and Status Register](#), places the LAN89218 MAC in the wake-up frame detection mode. In this mode, normal data reception is disabled, and detection logic within the MAC examines receive data for the pre-programmed wake-up frame patterns. The LAN89218 can be programmed to notify the host of the wake-up frame detection with the assertion of the host interrupt (IRQ) or assertion of the power management event signal (PME). Upon detection, the Wake-Up Frame Received bit (WUFR) in the WUCSR is set. When the host clears the WUEN bit the LAN89218 will resume normal receive operation.

Before putting the MAC into the wake-up frame detection state, the host must provide the detection logic with a list of sample frames and their corresponding byte masks. This information is written into the Wake-up Frame Filter register (WUFF). Refer to [Section 5.4.11, "WUFF—Wakeup Frame Filter," on page 120](#) for additional information on this register.

The MAC supports four programmable filters that support many different receive packet patterns. If remote wake-up mode is enabled, the remote wake-up function receives all frames addressed to the MAC. It then checks each frame against the enabled filter and recognizes the frame as a remote wake-up frame if it passes the wake-up frame filter register's address filtering and CRC value match.

In order to determine which bytes of the frames should be checked by the CRC module, the MAC uses a programmable byte mask and a programmable pattern offset for each of the four supported filters.

The pattern's offset defines the location of the first byte that should be checked in the frame. Since the destination address is checked by the address filtering function, the pattern offset is always greater than 12.

The byte mask is a 31-bit field that specifies whether or not each of the 31 contiguous bytes within the frame, beginning in the pattern offset, should be checked. If bit j in the byte mask is set, the detection logic checks byte offset $+j$ in the frame. In order to load the Wake-up Frame Filter register, the host LAN driver software must perform eight writes to the Wake-up Frame Filter register (WUFF). The Diagram shown in [Table 3.2, "Wake-Up Frame Filter Register Structure"](#) below, shows the wake-up frame filter register's structure.

Note: Wake-up frame detection can be performed when the LAN89218 is in the D0 or D1 power states. In the D0 state, wake-up frame detection is enabled when the WUEN bit is set.

Note: Wake-up frame detection, as well as Magic Packet detection, is always enabled and cannot be disabled when the device enters the D1 state.

Note: When wake-up frame detection is enabled via the WUEN bit of the [WUCSR—Wake-up Control and Status Register](#), a broadcast wake-up frame will wake-up the device despite the state of the Disable Broadcast Frame (BCAST) bit in the [MAC_CR—MAC Control Register](#).

Table 3.2 Wake-Up Frame Filter Register Structure

Filter 0 Byte Mask							
Filter 1 Byte Mask							
Filter 2 Byte Mask							
Filter 3 Byte Mask							
Reserved	Filter 3 Command	Reserved	Filter 2 Command	Reserved	Filter 1 Command	Reserved	Filter 0 Command
Filter 3 Offset		Filter 2 Offset		Filter 1 Offset		Filter 0 Offset	
Filter 1 CRC-16				Filter 0 CRC-16			
Filter 3 CRC-16				Filter 2 CRC-16			

The Filter i Byte Mask defines which incoming frame bytes Filter i will examine to determine whether or not this is a wake-up frame. [Table 3.3](#), describes the byte mask's bit fields.

Table 3.3 Filter i Byte Mask Bit Definitions

FILTER I BYTE MASK DESCRIPTION	
FIELD	DESCRIPTION
31	Must be zero (0)
30:0	Byte Mask: If bit j of the byte mask is set, the CRC machine processes byte number pattern - (offset + j) of the incoming frame. Otherwise, byte pattern - (offset + j) is ignored.

The Filter i command register controls Filter i operation. [Table 3.4](#) shows the Filter I command register.

Table 3.4 Filter i Command Bit Definitions

FILTER I COMMANDS	
FIELD	DESCRIPTION
3	Address Type: Defines the destination address type of the pattern. When bit is set, the pattern applies only to multicast frames. When bit is cleared, the pattern applies only to unicast frames.
2:1	Reserved
0	Enable Filter: When bit is set, Filter i is enabled, otherwise, Filter i is disabled.

The Filter i Offset register defines the offset in the frame's destination address field from which the frames are examined by Filter i. [Table 3.5](#) describes the Filter i Offset bit fields.

Table 3.5 Filter i Offset Bit Definitions

FILTER I OFFSET DESCRIPTION	
FIELD	DESCRIPTION
7:0	Pattern Offset: The offset of the first byte in the frame on which CRC is checked for wake-up frame recognition. The minimum value of this field must be 12 since there should be no CRC check for the destination address and the source address fields. The MAC checks the first offset byte of the frame for CRC and checks to determine whether the frame is a wake-up frame. Offset 0 is the first byte of the incoming frame's destination address.

The Filter i CRC-16 register contains the CRC-16 result of the frame that should pass Filter i.

[Table 3.6](#) describes the Filter i CRC-16 bit fields.

Table 3.6 Filter i CRC-16 Bit Definitions

FILTER I CRC-16 DESCRIPTION	
FIELD	DESCRIPTION
15:0	Pattern CRC-16: This field contains the 16-bit CRC value from the pattern and the byte mask programmed to the wake-up filter register Function. This value is compared against the CRC calculated on the incoming frame, and a match indicates the reception of a wakeup frame.

3.5.1 Magic Packet Detection

Setting the Magic Packet Enable bit (MPEN) in the [WUCSR—Wake-up Control and Status Register](#), places the LAN89218 MAC in the “Magic Packet” detection mode. In this mode, normal data reception is disabled, and detection logic within the MAC examines receive data for a Magic Packet. The LAN89218 can be programmed to notify the host of the “Magic Packet” detection with the assertion of the host interrupt (IRQ) or assertion of the power management event signal (PME). Upon detection, the Magic Packet Received bit (MPR) in the WUCSR is set. When the host clears the MPEN bit the LAN89218 will resume normal receive operation. Refer to [Section 5.4.12, “WUCSR—Wake-up Control and Status Register,” on page 121](#) for additional information on this register

In Magic Packet mode, the Power Management Logic constantly monitors each frame addressed to the node for a specific Magic Packet pattern. It checks only packets with the MAC's address or a broadcast address to meet the Magic Packet requirement. The Power Management Logic checks each received frame for the pattern 48h FF_FF_FF_FF_FF after the destination and source address field.

Then the Function looks in the frame for 16 repetitions of the MAC address without any breaks or interruptions. In case of a break in the 16 address repetitions, the PMT Function scans for the 48'hFF_FF_FF_FF_FF pattern again in the incoming frame.

The 16 repetitions may be anywhere in the frame but must be preceded by the synchronization stream. The device will also accept a multicast frame, as long as it detects the 16 duplications of the MAC address. If the MAC address of a node is 00h 11h 22h 33h 44h 55h, then the MAC scans for the following data sequence in an Ethernet: Frame.

```

Destination Address Source Address .....FF FF FF FF FF FF
00 11 22 33 44 55 00 11 22 33 44 55 00 11 22 33 44 55 00 11 22 33 44 55
00 11 22 33 44 55 00 11 22 33 44 55 00 11 22 33 44 55 00 11 22 33 44 55
00 11 22 33 44 55 00 11 22 33 44 55 00 11 22 33 44 55 00 11 22 33 44 55
00 11 22 33 44 55 00 11 22 33 44 55 00 11 22 33 44 55 00 11 22 33 44 55
...CRC
    
```

It should be noted that Magic Packet detection can be performed when LAN89218 is in the D0 or D1 power states. In the D0 state, “Magic Packet” detection is enabled when the MPEN bit is set. In the D1 state, Magic Packet detection, as well as wake-up frame detection, are automatically enabled when the device enters the D1 state.

3.6 Checksum Offload Engines (COE)

The LAN89218 contains two checksum offload engines, which offload the calculation of the 16-bit checksum for transmitted and received Ethernet frames. The functionality of the checksum offload engines is described in the following sections:

- [Receive Checksum Offload Engine \(RXCOE\)](#)
- [Transmit Checksum Offload Engine \(TXCOE\)](#)

3.6.1 Receive Checksum Offload Engine (RXCOE)

The receive checksum offload engine provides assistance to the CPU by calculating a 16-bit checksum for a received Ethernet frame. The RXCOE readily supports the following IEEE802.3 frame formats:

- Type II Ethernet frames
- SNAP encapsulated frames
- Support for up to 2, 802.1q VLAN tags

The resulting checksum value can also be modified by software to support other frame formats.

The RXCOE has two modes of operation. In mode 0, the RXCOE calculates the checksum between the first 14 bytes of the Ethernet frame and the FCS. This is illustrated in [Figure 3.2](#).

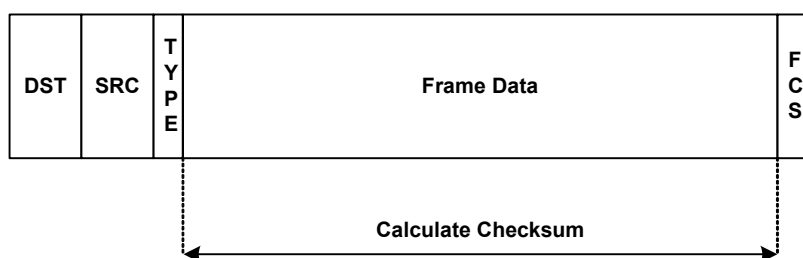

Figure 3.2 RXCOE Checksum Calculation

In mode 1, the RXCOE supports VLAN tags and a SNAP header. In this mode the RXCOE calculates the checksum at the start of L3 packet. The VLAN1 tag register is used by the RXCOE to indicate what protocol type is to be used to indicate the existence of a VLAN tag. This value is typically 8100h.

Example frame configurations:

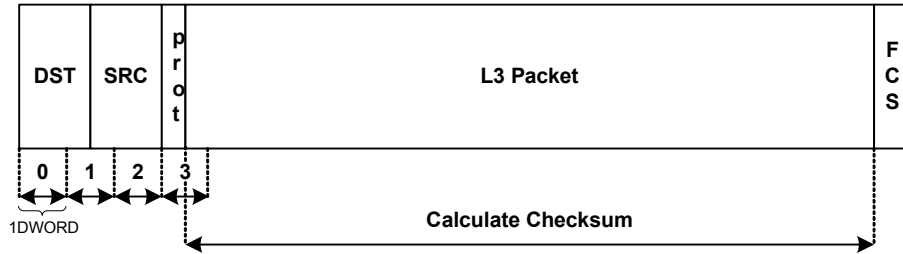

Figure 3.3 Type II Ethernet Frame

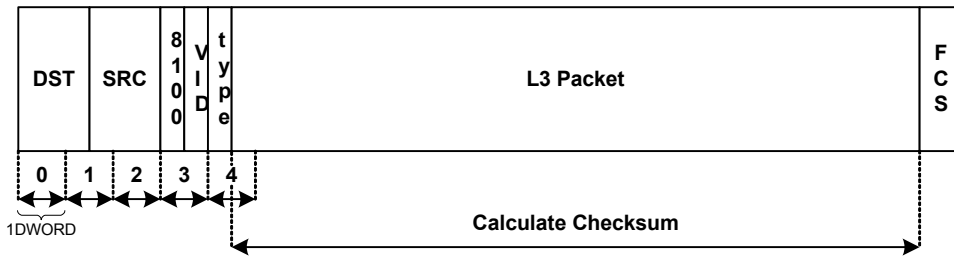

Figure 3.4 Ethernet Frame with VLAN Tag

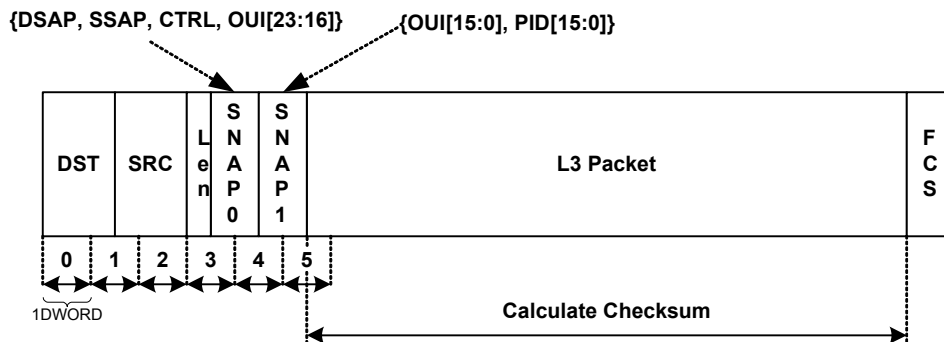

Figure 3.5 Ethernet Frame with Length Field and SNAP Header

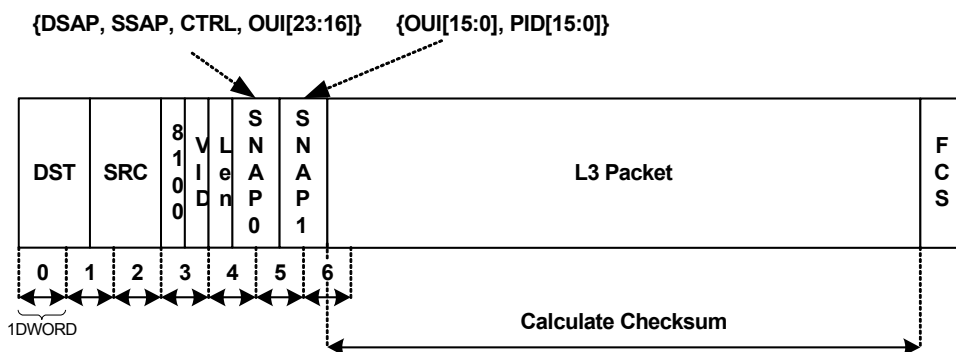

Figure 3.6 Ethernet Frame with VLAN Tag and SNAP Header

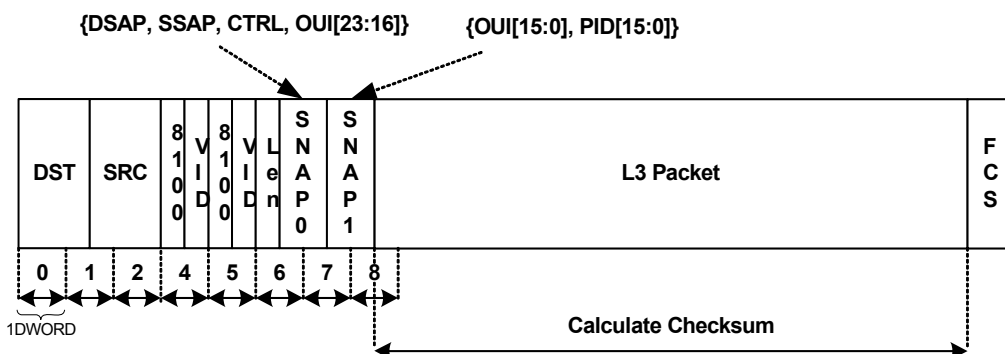

Figure 3.7 Ethernet Frame with multiple VLAN Tags and SNAP Header

The RXCOE supports a maximum of two VLAN tags. If there are more than two VLAN tags, the VLAN protocol identifier for the third tag is treated as an Ethernet type field. The checksum calculation will begin immediately after the type field.

The RXCOE resides in the RX path within the MAC. As the RXCOE receives an Ethernet frame it calculates the 16-bit checksum. The RXCOE passes the Ethernet frame to the RX Data FIFO with the checksum appended to the end of the frame. The RXCOE inserts the checksum immediately after the last byte of the Ethernet frame. The packet length field in the RX status word (refer to [Section 3.13.3](#)) will indicate that the frame size has increased by two bytes to accommodate the checksum.

The COE inserts the checksum immediately after the last byte of the Ethernet frame and before it transmits the status word. The status word is modified to indicate the frame size has increased by two bytes. The Packet Length field in the RX status word for the associated frame will indicate that the frame size has increased by two bytes to accommodate the checksum.

Note: When enabled, the RXCOE calculates a checksum for every received frame.

Setting the RXCOE_EN bit in the [COE_CR—Checksum Offload Engine Control Register](#) enables the RXCOE, and the RXCOE_MODE bit selects the operating mode. When the RXCOE is disabled, the the received frame and associated status must not be modified and received data is simply passed through the RXCOE.

Note: Software applications must stop the receiver and flush the RX data path before changing the state of the RXCOE_EN or RXCOE_MODE bits.

Note: When the RXCOE is enabled, automatic pad stripping must be disabled (bit 8 (PADSTR) of the [MAC_CR—MAC Control Register](#)) and vice versa. These functions cannot be enabled simultaneously.

3.6.1.1 RX Checksum Calculation

The checksum is calculated 16 bits at a time. In the case of an odd sized frame, an extra byte of zero is used to pad up to 16 bits.

Consider the following packet: DA, SA, Type, B0, B1, B2 ... BN, FCS

Let $[A, B] = A * 256 + B$;

If the packet has an even number of octets then

checksum = $[B1, B0] + C0 + [B3, B2] + C1 + \dots + [BN, BN-1] + CN-1$

Where C0, C1, ... CN-1 are the carry out results of the intermediate sums.

If the packet has an odd number of octets then

checksum = $[B1, B0] + C0 + [B3, B2] + C1 + \dots + [0, BN] + CN-1$

3.6.2 Transmit Checksum Offload Engine (TXCOE)

The transmit checksum offload engine provides assistance to the CPU by calculating a 16-bit checksum, typically for TCP, for a transmit Ethernet frame. The TXCOE calculates the checksum and inserts the results back into the data stream as it is transferred to the MAC.

To activate the TXCOE and perform a checksum calculation, the host must first set the TX checksum offload engine enable bit (TXCOE_EN) in the [COE_CR—Checksum Offload Engine Control Register](#). The host then pre-pends a 3 DWORD buffer to the data that will be transmitted. The pre-pended buffer includes a TX Command 'A', TX Command 'B', and a 32-bit TX checksum preamble. When bit 14 (CK) of the TX Command 'B' is set in conjunction with bit 13 (FS) of TX Command 'A' and bit 16 (TXCOE_EN) of the COE_CR register, the TXCOE will perform a checksum calculation on the associated packet. When these three bits are set, a 32-bit TX checksum preamble must be pre-pended to the beginning of the TX packet (refer to [Table 3.7](#)). The TX checksum preamble instructs the TXCOE on the handling of the associated packet. Bits 11:0 of the TX checksum preamble define the byte offset at which the data checksum calculation will begin (TXCSSP). The checksum calculation will begin at this offset and will continue until the end of the packet. When the calculation is complete, the checksum will be inserted into the packet at the byte offset defined by bits 27:16 of the TX checksum preamble (TXCSLOC). If the CK bit is not set in the first TX Command 'B' of a packet, the packet is passed directly through the TXCOE without modification, regardless if the TXCOE_EN is set.

Note: The data checksum calculation must not begin in the MAC header (first 14 bytes) or in the last 4 bytes of the TX packet.

Note: The TX checksum cannot be inserted in the MAC header (first 14 bytes) or in the last 4 bytes of the TX packet.

An example of a TX packet with a pre-pended TX checksum preamble can be found in [Section 3.12.6.3, "TX Example 3"](#). In this example the host writes the packet data to the ethernet controller in four fragments, the first containing the TX Checksum Preamble. [Figure 3.24](#) shows how these

fragments are loaded into the TX Data FIFO. For more information on the TX Command 'A' and TX Command 'B', refer to [Section 3.12.2, "TX Command Format"](#).

If the TX packet already includes a partial checksum calculation (perhaps inserted by an upper layer protocol), this checksum can be included in the hardware checksum calculation by setting the TXCSSP field in the TX checksum preamble to include the partial checksum. The partial checksum can be replaced by the completed checksum calculation by setting the TXCSLOC pointer to point to the location of the partial checksum.

Table 3.7 TX Checksum Preamble

FIELD	DESCRIPTION
31:28	Reserved
27:16	TXCSLOC - TX Checksum Location This field specifies the byte offset where the TX checksum will be inserted in the TX packet. The checksum will replace two bytes of data starting at this offset. Note: The TX checksum cannot be inserted in the MAC header (first 14 bytes) or in the last 4 bytes of the TX packet.
15:12	Reserved
11:0	TXCSSP - TX Checksum Start Pointer This field indicates start offset, in bytes, where the checksum calculation will begin in the associated TX packet. Note: The data checksum calculation must not begin in the MAC header (first 14 bytes) or in the last 4 bytes of the TX packet.

Note: When the TXCOE is enabled, the third DWORD of the pre-pended packet is not transmitted. However, 4 bytes must be added to the packet length field in TX Command 'B'.

Note: The TX checksum preamble must be DWORD-aligned (i.e., the two least significant bits of the Data Start Offset fields in TX Command "A" must be zero). Any valid buffer end alignment setting can be used.

Note: Software applications must stop the transmitter and flush the TX data path before changing the state of the TXCOE_EN bit. However, the CK bit of TX Command 'B' can be set or cleared on a per-packet basis.

3.6.2.1 TX Checksum Calculation

The TX checksum calculation is performed using the same operation as the RX checksum shown in [Section 3.6.1.1](#), with the exception that the calculation starts as indicated by the preamble, and the transmitted checksum is the one's-complement of the final calculation.

Note: When the TX checksum offload feature is invoked, if the calculated checksum is 0000h, it is left unaltered. UDP checksums are optional under IPv4, and a zero checksum calculated by the TX checksum offload feature will erroneously indicate to the receiver that no checksum was calculated, however, the packet will typically not be rejected by the receiver. Under IPv6, however, according to RFC 2460, the UDP checksum is not optional. A calculated checksum that yields a result of zero must be changed to FFFFh for insertion into the UDP header. IPv6 receivers discard UDP packets containing a zero checksum. **Thus, this feature must not be used for UDP checksum calculation under IPv6.**

3.7 Host Bus Operations

3.7.1 32-bit vs. 16-bit Host Bus Width Operation

The LAN89218 can be configured to communicate with the host bus via either a 32-bit or a 16-bit bus. The external strap D32/nD16 (on the EEDIO pin) is used to select between the two modes. 32-bit mode is the native environment for the LAN89218 Ethernet controller and no special requirements exist for communication in this mode. However, when this part is used in the 16-bit mode, two writes or reads must be performed back to back to properly communicate.

The bus width is set by strapping the EEDIO pin; this setting can be read from bit 2 of the "Hardware Configuration Register". Refer to [Section 5.3.9, "HW_CFG—Hardware Configuration Register," on page 93](#) for additional information on this register.

3.7.2 16-bit Bus Writes

The host processor is required to perform two contiguous 16-bit writes to complete a single DWORD transfer. This DWORD must begin and end on a DWORD address boundary (A[2] and higher, cannot change during a sixteen bit write). No ordering requirements exist. The processor can access either the low or high word first, as long as the next write is performed to the other word. If a write to the same word is performed, the LAN89218 disregards the transfer.

3.7.3 16-bit Bus Reads

The host processor is required to perform two consecutive 16-bit reads to complete a single DWORD transfer. This DWORD must begin and end on a DWORD address boundary (A[2] and higher, cannot change during a sixteen bit read). No ordering requirements exist. The processor can access either the low or high word first, as long as the next read is performed from the other word. If a read to the same word is performed, the data read is invalid and should be re-read. This is not a fatal error. The LAN89218 will reset its read counters and restart a new cycle on the next read. The Upper 16 data pins (D[31:16]) are not driven by the LAN89218 in 16-bit mode. These pins have internal pull-down's and the signals are left in a high-impedance state.

3.7.4 Mixed Endian Support

In order to allow flexibility with a range of designs, the LAN89218 supports dynamic bus endianness selection. Support for big and little endian host byte ordering is provided based on the END_SEL signal. This signal has the same timing characteristics as FIFO_SEL and the address line input pins. When END_SEL is low, bus accesses utilize little endian byte ordering. When END_SEL is high, bus accesses utilize big endian byte ordering. In a typical application, END_SEL may be connected to a high-order address line, making the endian selection address-based. This highly flexible interface provides mixed endian access for registers and memory for both PIO and host DMA access. For example, PIO transfers to/from the host control and status registers can utilize a different byte ordering than host DMA transactions to/from the receive and transmit data FIFOs.

In addition to mixed endian support, the LAN89218 provides a word swap function, as described in [Section 3.7.5](#). The word swap function combined with the endianness select bits described above determines how the Data/Status FIFOs and CSR host access byte ordering is applied. [Table 3.9](#) describes the various operation modes of the endianness and word swap ordering logic. [Figure 3.10](#) illustrates the FIFO access byte ordering under various endianness and word swap settings. Refer to [Section 3.7.5](#) for additional details.

Note: All internal busses of the LAN89218 are 32-bits wide with little endian byte ordering.

3.7.5 Word Swap Function

In addition to mixed endian functionality, the LAN89218 supports a Word Swap Function when its Host Bus Interface is configured to operate in 16-bit mode. This feature is controlled by the Word Swap register, which is described in [Section 5.3.17, "WORD_SWAP—Word Swap Control," on page 102](#). This register affects how words on the data bus are written to or read from the Control and Status Registers and the Transmit and Receive Data/Status FIFOs.

Note: The Word Swap register only takes effect when the LAN89218 is configured to operate in 16-bit mode. In 32-bit mode, this register is ignored and the upper data bits, D[31:16], are always mapped to the high-order word, and the lower data bits, D[15:0], are always mapped to the low-order word.

Logic within LAN89218 reorders bytes based on the host bus width (D32/nD16 strap), the setting of the WORD_SWAP register (16-bit mode of operation only), the state of the endian select signal (END_SEL), and the state of the least significant address line (A1). [Figure 3.8](#) illustrates the order in which the word swap and endianess select logic is applied within the LAN89218. Logically, the endian ordering logic is applied after the word swap logic for write operations, and before the word swap logic for read operations.

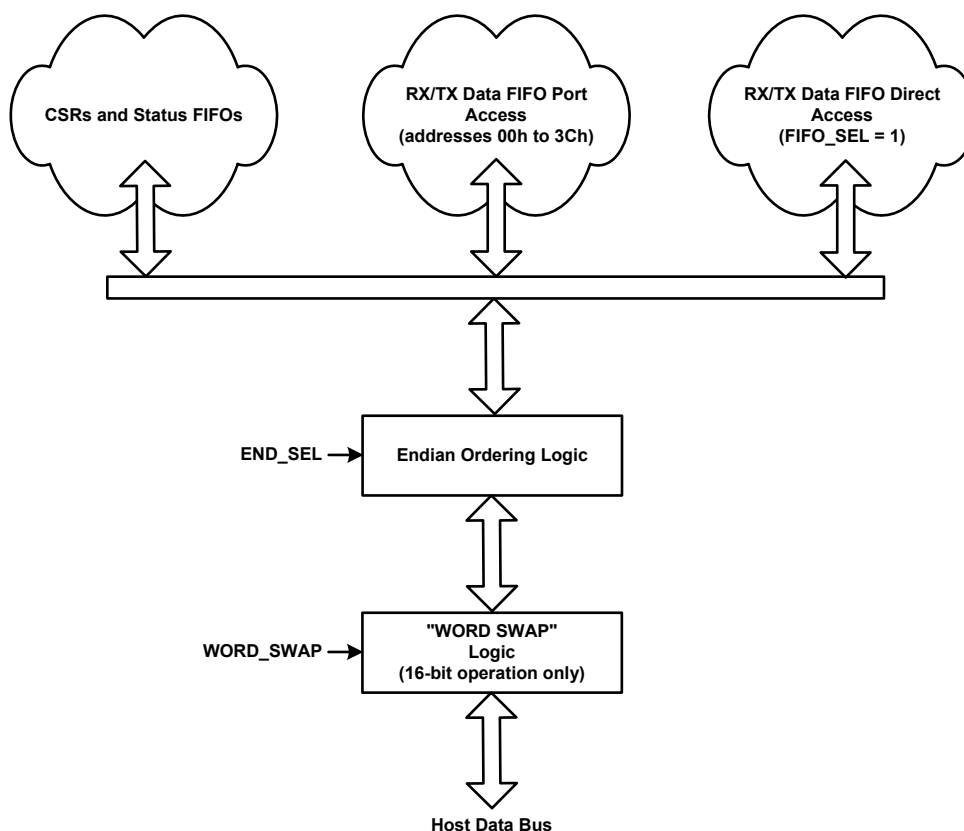

Figure 3.8 Host Data Path Diagram

Data path operations for the various supported endianess and word swap configurations are illustrated in [Figure 3.9](#) and [Figure 3.10](#), and [Table 3.9](#) illustrate the byte ordering applied by the endian logic for each type of host access. This figure and table assume an internal byte ordering of 3-2-1-0, where '3' is the most significant byte (data[31:24]) and '0' is the least significant byte (data[7:0]).

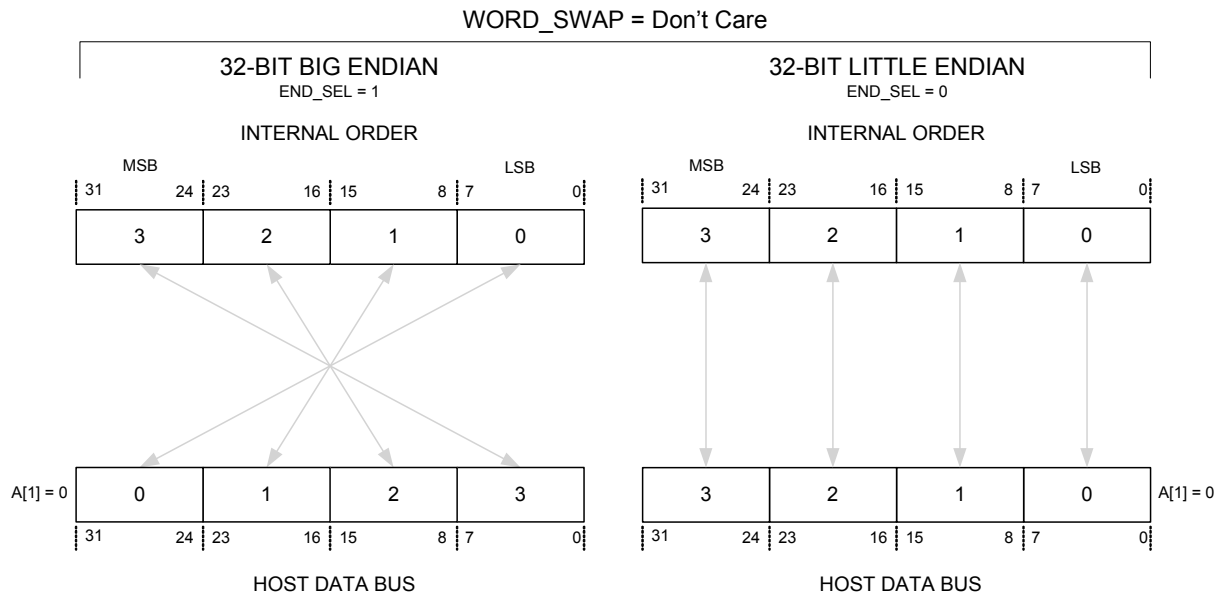

Figure 3.9 32-bit Byte Ordering

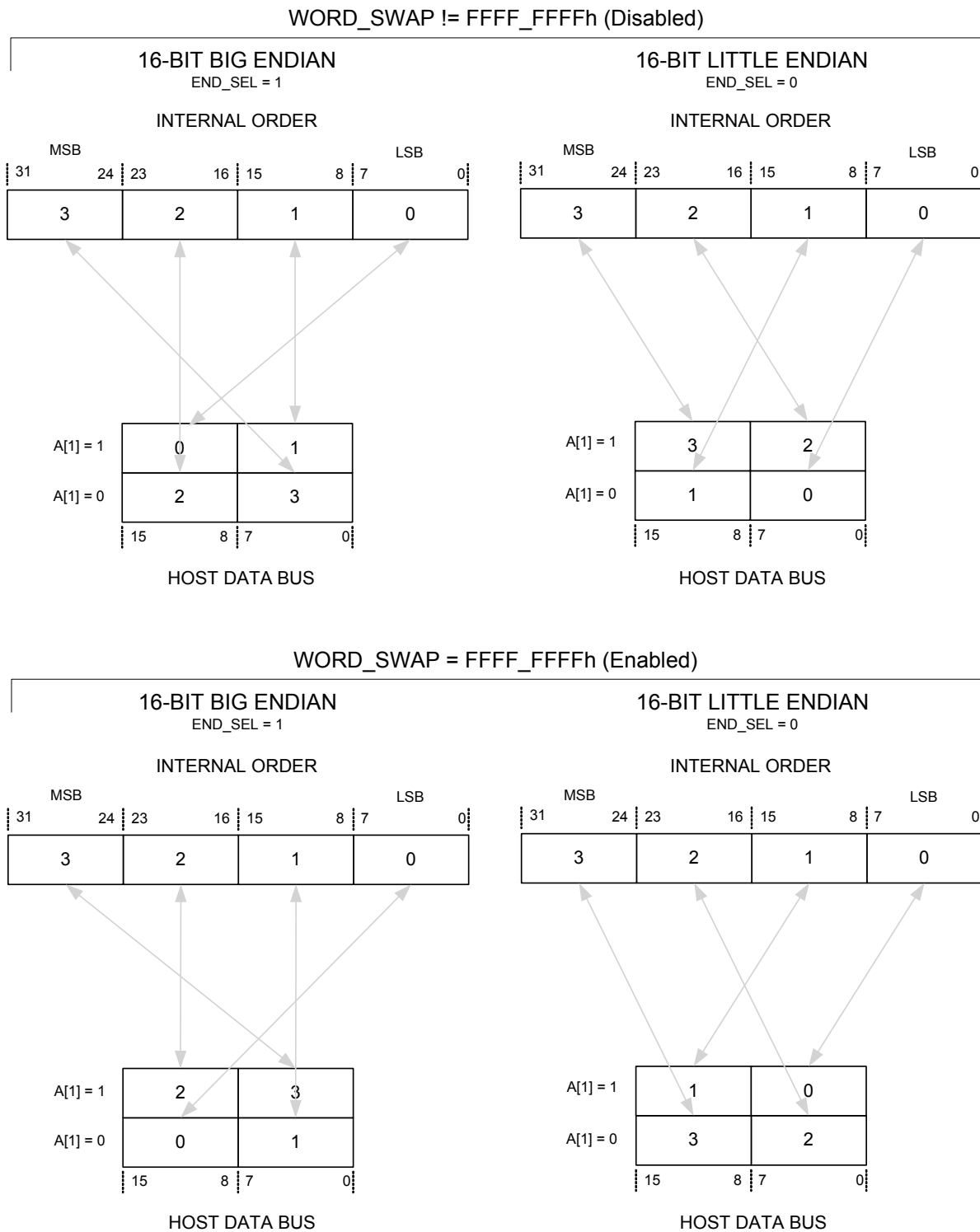

Figure 3.10 16-Bit Byte Ordering

Table 3.8 32-Bit Endian Ordering Logic Operation

	Host Data Bus			
	D[31:24]	D[23:16]	D[15:8]	D[7:0]
END_SEL = 0	3	2	1	0
END_SEL = 1	0	1	2	3

Table 3.9 16-Bit Endian Ordering Logic Operation

			Host Data Bus	
			D[15:8]	D[7:0]
WORD_SWAP != FFFF_FFFFh	END_SEL = 0	A1=1	3	2
		A1=0	1	0
	END_SEL = 1	A1=1	0	1
		A1=0	2	3
WORD_SWAP = FFFF_FFFFh	END_SEL = 0	A1=1	1	0
		A1=0	3	2
	END_SEL = 1	A1=1	2	3
		A1=0	0	1

3.8 General Purpose Timer (GP Timer)

The General Purpose Timer is a programmable block that can be used to generate periodic host interrupts. The resolution of this timer is 100 μ s.

The GP Timer loads the GPT_CNT Register with the value in the GPT_LOAD field and begins counting down when the TIMER_EN bit is set to a '1.' On a reset, or when the TIMER_EN bit changes from set '1' to cleared '0,' the GPT_LOAD field is initialized to FFFFh. The GPT_CNT register is also initialized to FFFFh on a reset. Software can write the pre-load value into the GPT_LOAD field at any time; e.g., before or after the TIMER_EN bit is asserted. The GPT Enable bit TIMER_EN is located in the GPT_CFG register.

Once enabled, the GPT counts down either until it reaches 0000h or until a new pre-load value is written to the GPT_LOAD field. At 0000h, the counter wraps around to FFFFh, asserts the GPT interrupt status bit and the IRQ signal if the GPT_INT_EN bit is set, and continues counting. The GPT interrupt status bit is in the INT_STS Register. The GPT_INT hardware interrupt can only be set if the GPT_INT_EN bit is set. GPT_INT is a sticky bit (R/WC); i.e., once the GPT_INT bit is set, it can only be cleared by writing a '1' to the bit.

3.9 EEPROM Interface

The LAN89218 can optionally load its MAC address from an external serial EEPROM. If a properly configured EEPROM is detected by the LAN89218 at power-up, hard reset or soft reset, the ADDRH and ADDRL registers will be loaded with the contents of the EEPROM. If a properly configured EEPROM is not detected, it is the responsibility of the host LAN Driver to set the IEEE addresses.

The LAN89218 EEPROM controller also allows the host system to read, write and erase the contents of the Serial EEPROM. The EEPROM controller supports most "93C46" type EEPROMs configured for 128 x 8-bit operation.

3.9.1 MAC Address Auto-Load

On power-up, hard reset or soft reset, the EEPROM controller attempts to read the first byte of data from the EEPROM (address 00h). If the value A5h is read from the first address, then the EEPROM controller will assume that an external Serial EEPROM is present. The EEPROM controller will then access the next EEPROM byte and send it to the MAC Address register byte 0 (ADDRL[7:0]). This process will be repeated for the next five bytes of the MAC Address, thus fully programming the 48-bit MAC address. Once all six bytes have been programmed, the "MAC Address Loaded" bit is set in the E2P_CMD register. A detailed explanation of the EEPROM byte ordering with respect to the MAC address is given in [Section 5.4.3, "ADDRL—MAC Address Low Register," on page 115](#).

If an 0xA5h is not read from the first address, the EEPROM controller will end initialization. It is then the responsibility of the host LAN driver software to set the IEEE address by writing to the MAC's ADDRH and ADDRL registers.

The host can initiate a reload of the MAC address from the EEPROM by issuing the RELOAD command via the E2P command (E2P_CMD) register. If the first byte read from the EEPROM is not A5h, it is assumed that the EEPROM is not present, or not programmed, and the MAC address reload will fail. The "MAC Address Loaded" bit indicates a successful reload of the MAC address.

3.9.2 EEPROM Host Operations

After the EEPROM controller has finished reading (or attempting to read) the MAC after power-on, hard reset or soft reset, the host is free to perform other EEPROM operations. EEPROM operations are performed using the E2P_CMD and E2P data (E2P_DATA) registers. [Section 5.3.23, "E2P_CMD – EEPROM Command Register," on page 107](#) provides an explanation of the supported EEPROM operations.

If the EEPROM operation is the "write location" (WRITE) or "write all" (WRAL) commands, the host must first write the desired data into the E2P_DATA register. The host must then issue the WRITE or WRAL command using the E2P_CMD register by setting the EPC_CMD field appropriately. If the operation is a WRITE, the EPC_ADDR field in E2P_CMD must also be set to the desired location. The command is executed when the host sets the EPC_BSY bit high. The completion of the operation is indicated when the EPC_BSY bit is cleared.

If the EEPROM operation is the "read location" (READ) operation, the host must issue the READ command using the E2P_CMD with the EPC_ADDR set to the desired location. The command is executed when the host sets the EPC_BSY bit high. The completion of the operation is indicated when the EPC_BSY bit is cleared, at which time the data from the EEPROM may be read from the E2P_DATA register.

Other EEPROM operations are performed by writing the appropriate command to the EPC_CMD register. The command is executed when the host sets the EPC_BSY bit high. The completion of the operation is indicated when the EPC_BSY bit is cleared. In all cases the host must wait for EPC_BSY to clear before modifying the E2P_CMD register.

Note: The EEPROM device powers-up in the erase/write disabled state. To modify the contents of the EEPROM the host must first issue the EWEN command.

If an operation is attempted, and an EEPROM device does not respond within 30 ms, the LAN89218 will timeout, and the EPC timeout bit (EPC_TO) in the E2P_CMD register will be set.

Figure 3.11, "EEPROM Access Flow Diagram" illustrates the host accesses required to perform an EEPROM Read or Write operation.

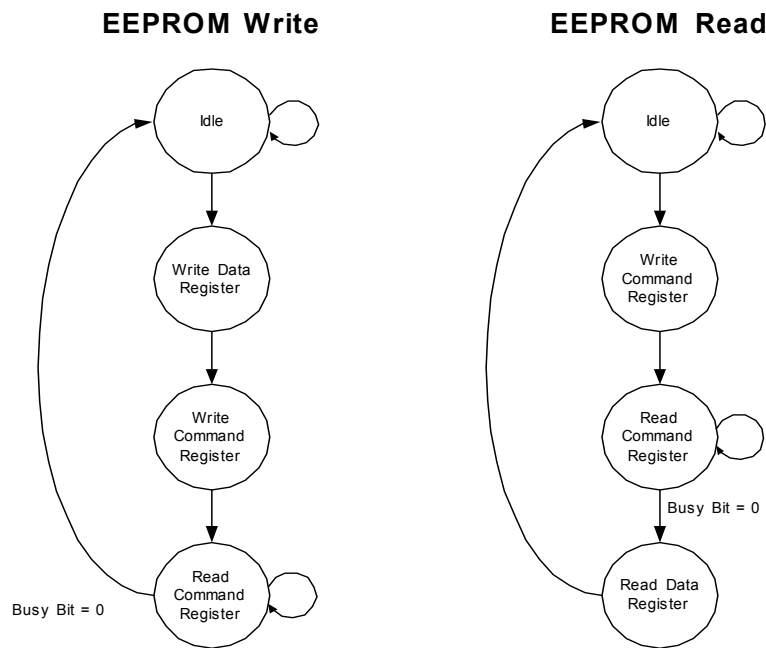

Figure 3.11 EEPROM Access Flow Diagram

The host can disable the EEPROM interface through the GPIO_CFG register. When the interface is disabled, the EEDIO and ECLK signals can be used as general-purpose outputs, or they may be used to monitor internal MII signals.

3.9.2.1 Supported EEPROM Operations

The EEPROM controller supports the following EEPROM operations under host control via the E2P_CMD register. The operations are commonly supported by “93C46” EEPROM devices. A description and functional timing diagram is provided below for each operation. Refer to the E2P_CMD register description in [Section 5.3.23, "E2P_CMD – EEPROM Command Register," on page 107](#) for E2P_CMD field settings for each command.

ERASE (Erase Location): If erase/write operations are enabled in the EEPROM, this command will erase the location selected by the EPC Address field (EPC_ADDR). The EPC_TO bit is set if the EEPROM does not respond within 30 ms.

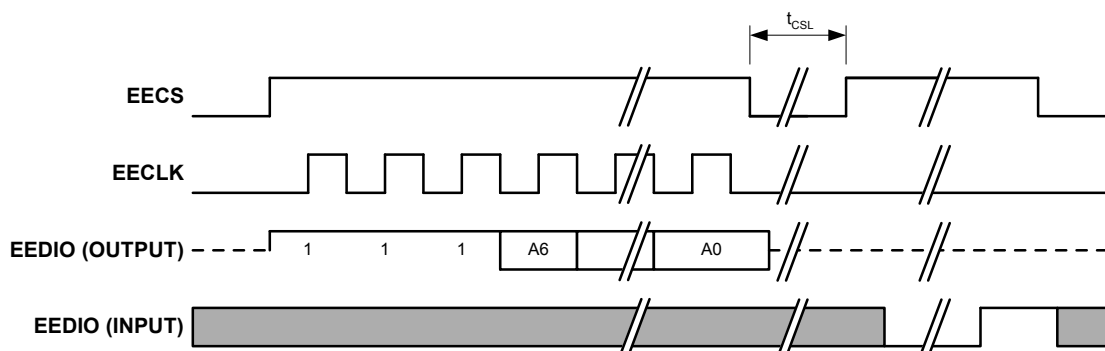

Figure 3.12 EEPROM ERASE Cycle

ERAL (Erase All): If erase/write operations are enabled in the EEPROM, this command will initiate a bulk erase of the entire EEPROM. The EPC_TO bit is set if the EEPROM does not respond within 30 ms.

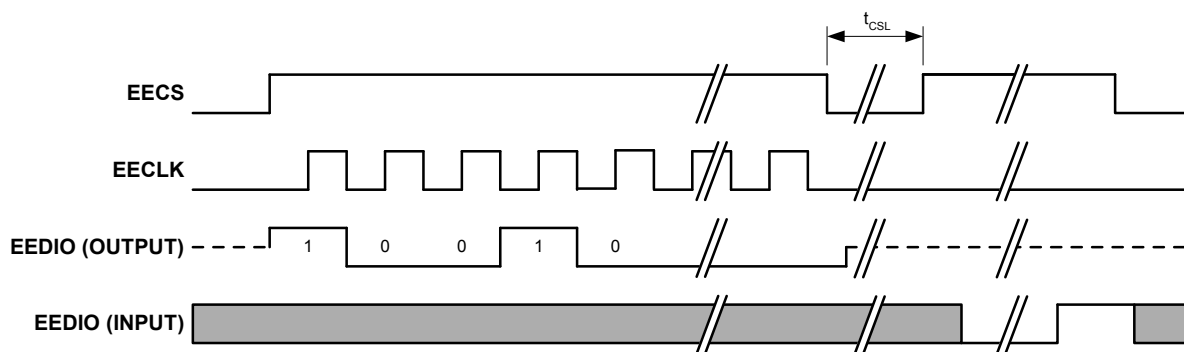

Figure 3.13 EEPROM ERAL Cycle

EWDS (Erase/Write Disable): After issued, the EEPROM will ignore erase and write commands. To re-enable erase/write operations issue the EWEN command.

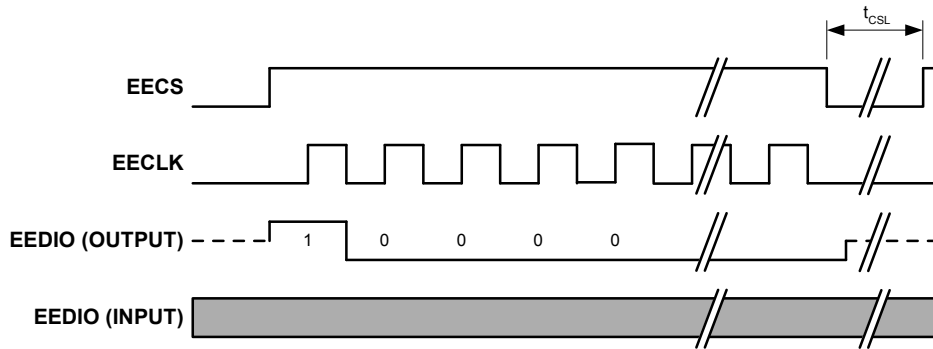

Figure 3.14 EEPROM EWDS Cycle

EWEN (Erase/Write Enable): Enables the EEPROM for erase and write operations. The EEPROM will allow erase and write operations until the “Erase/Write Disable” command is sent, or until power is cycled.

Note: The EEPROM device will power-up in the erase/write-disabled state. Any erase or write operations will fail until an Erase/Write Enable command is issued.

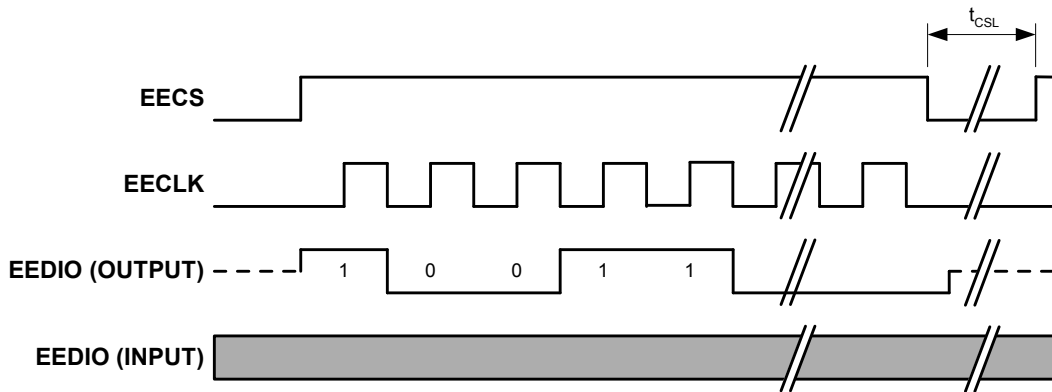

Figure 3.15 EEPROM EWEN Cycle

READ (Read Location): This command will cause a read of the EEPROM location pointed to by EPC Address (EPC_ADDR). The result of the read is available in the E2P_DATA register.

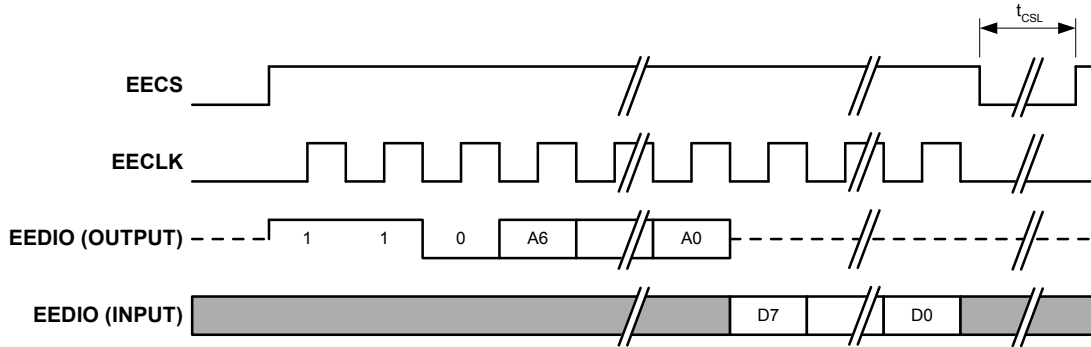

Figure 3.16 EEPROM READ Cycle

WRITE (Write Location): If erase/write operations are enabled in the EEPROM, this command will cause the contents of the E2P_DATA register to be written to the EEPROM location selected by the EPC Address field (EPC_ADDR). The EPC_TO bit is set if the EEPROM does not respond within 30 ms.

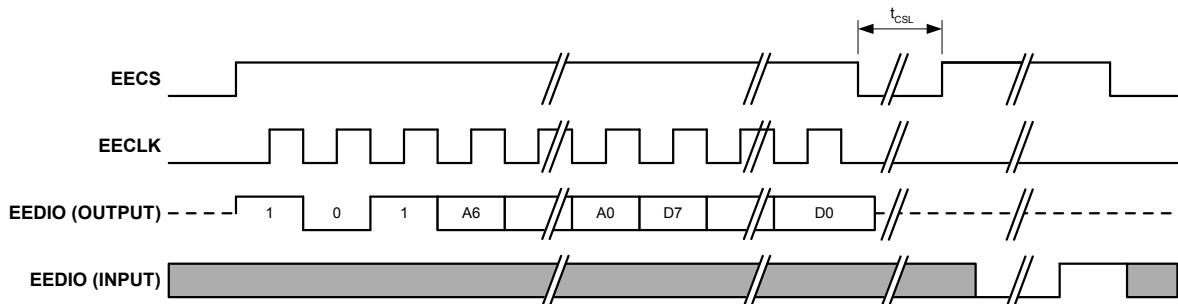

Figure 3.17 EEPROM WRITE Cycle

WRAL (Write All): If erase/write operations are enabled in the EEPROM, this command will cause the contents of the E2P_DATA register to be written to every EEPROM memory location. The EPC_TO bit is set if the EEPROM does not respond within 30 ms.

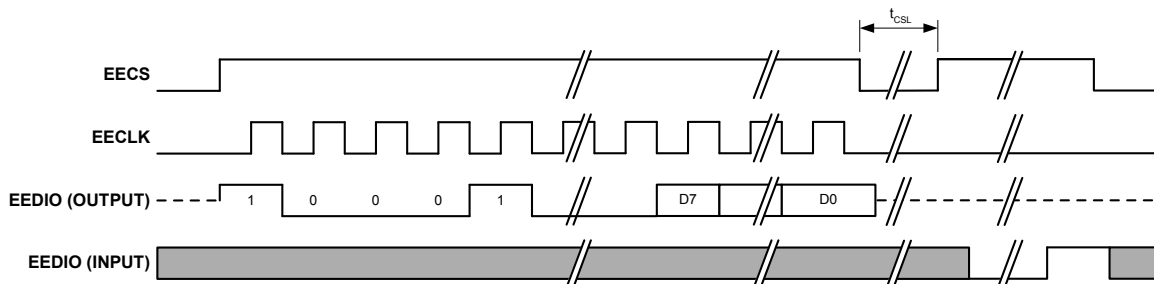

Figure 3.18 EEPROM WRAL Cycle

Table 3.10, "Required EECLK Cycles", shown below, shows the number of EECLK cycles required for each EEPROM operation.

Table 3.10 Required EECLK Cycles

OPERATION	REQUIRED EECLK CYCLES
ERASE	10
ERAL	10
EWDS	10
EWEN	10
READ	18
WRITE	18
WRAL	18

3.9.2.2 MAC Address Reload

The MAC address can be reloaded from the EEPROM via a host command to the E2P_CMD register. If a value of 0xA5h is not found in the first address of the EEPROM, the EEPROM is assumed to be un-programmed and MAC Address Reload operation will fail. The "MAC Address Loaded" bit indicates a successful load of the MAC address. The EPC_LOAD bit is set after a successful reload of the MAC address.

3.9.2.3 EEPROM Command and Data Registers

Refer to [Section 5.3.23, "E2P_CMD – EEPROM Command Register," on page 107](#) and [Section 5.3.24, "E2P_DATA – EEPROM Data Register," on page 109](#) for a detailed description of these registers. Supported EEPROM operations are described in these sections.

3.9.2.4 EEPROM Timing

Refer to [Section 6.9, "EEPROM Timing," on page 144](#) for detailed EEPROM timing specifications.

3.10 Power Management

The LAN89218 supports power-down modes to allow applications to minimize power consumption. The following sections describe these modes.

3.10.1 System Description

Power is reduced to various modules by disabling the clocks as outlined in Table 3.11, “Power Management States,” on page 50. All configuration data is saved when in either of the two low power states. Register contents are not affected unless specifically indicated in the register description.

3.10.2 Functional Description

There is one normal operating power state, D0 and there are two power saving states: D1, and D2. Upon entry into either of the two power saving states, only the PMT_CTRL register is accessible for read operations. In either of the power saving states the READY bit in the PMT_CTRL register will be cleared. Reads of any other addresses are forbidden until the READY bit is set. All writes, with the exception of the wakeup write to BYTE_TEST, are also forbidden until the READY bit is set. Only when in the D0 (Normal) state, when the READY bit is set, can the rest of the device be accessed.

Note: The LAN89218 must always be read at least once after power-up, reset, or upon return from a power-saving state, otherwise write operations will not function.

In system configurations where the PME signal is shared amongst multiple devices, the WUPS field within the PMT_CTRL register can be read to determine which LAN89218 device is driving the PME signal.

When the LAN89218 is in a power saving state (D1 or D2), a write cycle to the BYTE_TEST register will return the LAN89218 to the D0 state. [Table 7.3, “Power Consumption Device and System Components,” on page 147](#) and [Table 7.3, “Power Consumption Device and System Components,” on page 147](#), shows the power consumption values for each power state.

Note: When the LAN89218 is in a power saving state, a write of any data to the BYTE_TEST register will wake-up the device. DO NOT PERFORM WRITES TO OTHER ADDRESSES while the READY bit in the PMT_CTRL register is cleared.

After issuing a write to the BYTE_TEST register to wake the LAN89218 from a power-down state, the READY bit in PMT_CTRL will assert (set High) within 2 ms.

APPLICATION NOTE: Under normal conditions, the READY bit in PMT_CTRL will be set (high -"1") within 2 ms. If the software driver polls this bit and it is not set within 100ms, then an error condition occurred.

3.10.2.1 D1 Sleep

Power consumption is reduced in this state by disabling clocks to portions of the internal logic as shown in [Table 3.11](#). In this mode the clock to the internal PHY and portions of the MAC are still operational. This state is entered when the host writes a '01' to the PM_MODE bits in the Power Management (PMT_CTRL) register. The READY bit in PMT_CTRL is cleared when entering the D1 state.

Wake-up frame and Magic Packet detection are automatically enabled in the D1 state. If properly enabled via the WOL_EN and PME_EN bits, the LAN89218 will assert the PME hardware signal upon the detection of the wake-up frame or magic packet. The LAN89218 can also assert the host interrupt (IRQ) on detection of a wake-up frame or magic packet. Upon detection, the WUPS field in PMT_CTRL will be set to a 10b.

Note: The PME interrupt status bit (PME_INT) in the INT_STS register is set regardless of the setting of PME_EN.

Note: Wake-up frame and Magic Packet detection is automatically enabled when entering the D1 state. For wake-up frame detection, the wake-up frame filter must be programmed before entering the D1 state (see [Section 3.5, "Wake-up Frame Detection," on page 29](#)). If used, the host interrupt and PME signal must be enabled prior to entering the D1 state.

A write to the BYTE_TEST register, regardless of whether a wake-up frame or Magic Packet was detected, will return LAN89218 to the D0 state and will reset the PM_MODE field to the D0 state. As noted above, the host is required to check the READY bit and verify that it is set before attempting any other reads or writes of the device.

Note: The host must only perform read accesses prior to the ready bit being set.

Once the READY bit is set, the LAN89218 is ready to resume normal operation. At this time the WUPS field can be cleared.

3.10.2.2 D2 Sleep

In this state, as shown in [Table 3.11](#), all clocks to the MAC and host bus are disabled and the PHY is placed in a reduced power state. To enter this state, the EDPWRDOWN bit in register 17 of the PHY (Mode Control/Status register) must be set. This places the PHY in the Energy Detect mode. The PM_MODE bits in the PMT_CTRL register must then be set to 10b. Upon setting the PM_MODE bits, the LAN89218 will enter the D2 sleep state. The READY bit in PMT_CTRL is cleared when entering the D2 state.

Note: If carrier is present when this state is entered detection will occur immediately.

If properly enabled via the ED_EN and PME_EN bits, the LAN89218 will assert the PME hardware signal upon detection of a valid carrier. Upon detection, the WUPS field in PMT_CTRL will be set to a 01b.

Note: The PME interrupt status bit on the INT_STS register (PME_INT) is set regardless of the setting of PME_EN.

A write to the BYTE_TEST register, regardless of whether a carrier was detected, will return the LAN89218 to the D0 state and will reset the PM_MODE field to the D0 state. As noted above, the host is required to check the READY bit and verify that it is set before attempting any other reads or writes of the device. Before the LAN89218 is fully awake from this state the EDPWRDOWN bit in register 17 of the PHY must be cleared in order to wake the PHY. Do not attempt to clear the EDPWRDOWN bit until the READY bit is set. After clearing the EDPWRDOWN bit the LAN89218 is ready to resume normal operation. At this time the WUPS field can be cleared.

Table 3.11 Power Management States

Device BLOCK	D0 (NORMAL OPERATION)	D1 (WOL)	D2 (ENERGY DETECT)
PHY	Full ON	Full ON	Energy Detect Power-Down
MAC Power Management	Full ON	RX Power Mgmt. Block On	OFF
MAC and Host Interface	Full ON	OFF	OFF
Internal Clock	Full ON	Full ON	OFF

KEY
CLOCK ON
BLOCK DISABLED – CLOCK ON
FULL OFF

3.10.2.3 Power Management Event Indicators

Figure 3.19 is a simplified block diagram of the logic that controls the external PME, and internal pme_interrupt signals. The pme_interrupt signal is used to set the PME_INT status bit in the INT_STS register, which, if enabled, will generate a host interrupt upon detection of a power management event. The PME_INT status bit in INT_STS will remain set until the internal pme_interrupt signal is cleared by clearing the WUPS bits, or by clearing the corresponding WOL_EN or ED_EN bit. After clearing the internal pme_interrupt signal, the PME_INT status bit may be cleared by writing a '1' to this bit in the INT_STS register. It should be noted that the LAN89218 can generate a host interrupt regardless of the state of the PME_EN bit, or the external PME signal.

The external PME signal can be setup for pulsed, or static operation. When the PME_IND bit in the PMT_CTRL register is set to a '1', the external PME signal will be driven active for 50ms upon detection of a wake-up event. When the PME_IND bit is cleared, the PME signal will be driven continuously upon detection of a wake-up event. The PME signal is deactivated by clearing the WUPS bits, or by clearing the corresponding WOL_EN or ED_EN bit. The PME signal can also be deactivated by clearing the PME_EN bit.

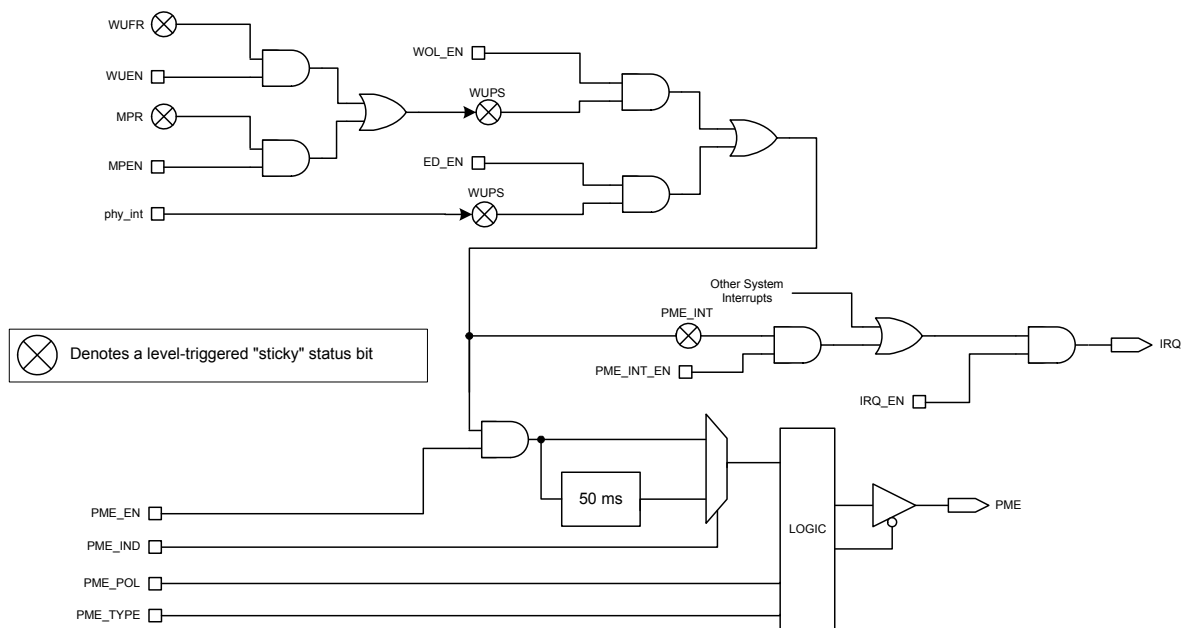

Figure 3.19 PME and PME_INT Signal Generation

3.10.3 Internal PHY Power-Down modes

There are 2 power-down modes for the internal PHY:

3.10.3.1 General Power-Down

This power-down is controlled by register 0, bit 11. In this mode the internal PHY, except the management interface, is powered-down and stays in that condition as long as Phy register bit 0.11 is HIGH. When bit 0.11 is cleared, the PHY powers up and is automatically reset. Refer to [Section 5.5.1, "Basic Control Register," on page 124](#) for additional information on this register.

3.10.3.2 Energy Detect Power-Down

This power-down mode is activated by setting the Phy register bit 17.13 to 1. Refer to [Section 5.5.8, "Mode Control/Status," on page 128](#) for additional information on this register. In this mode when no energy is present on the line, the PHY is powered down, with the exception of the management interface, the SQUELCH circuit and the ENERGYON logic. The ENERGYON logic is used to detect the presence of valid energy from 100Base-TX, 10Base-T, or Auto-negotiation signals

In this mode, when the ENERGYON signal is low, the PHY is powered-down, and nothing is transmitted. When energy is received - link pulses or packets - the ENERGYON signal goes high, and the PHY powers-up. It automatically resets itself into the state it had prior to power-down, and asserts the INT7.1 bit of the register defined in [Section 5.5.11, "Interrupt Source Flag," on page 131](#). If the ENERGYON interrupt is enabled, this event will cause an interrupt to the host. The first and possibly the second packet to activate ENERGYON may be lost. When 17.13 is low, energy detect power-down is disabled.

3.11 Detailed Reset Description

The LAN89218 has five reset sources:

- Power-On Reset (POR)
- Hardware Reset Input Pin (nRESET)
- Soft Reset (SRST)
- PHY Soft Reset via PMT_CTRL bit 10 (PHY_RST)
- PHY Soft Reset via PHY Basic Control Register (PHY REG 0.15)

[Table 3.12](#) shows the effect of the various reset sources on the LAN89218 's circuitry.

Table 3.12 Reset Sources and Affected Circuitry

RESET SOURCE	PLL	HBI Note 3.3	NASR REGISTERS Note 3.3	MIL	MAC	PHY Note 3.1	EEPROM MAC ADDR. RELOAD Note 3.2	CONFIG. STRAPS LATCHED
POR	X	X	X	X	X	X	X	X
nRESET	X	X	X	X	X	X	X	X
SRST		X		X	X		X	
PHY_RST						X		
PHY REG 0.15						X		

Note 3.1 After any PHY reset, the application must wait until the "Link Status" bit in the PHY's "Basic Status Register" (PHY Reg. 1.2) is set before attempting to transmit or receive data.

Note 3.2 After a POR, nRESET or SRST, the LAN89218 will automatically check for the presence of an external EEPROM. After any of these resets the application must verify that the EPC Busy Bit (E2P_CMD, bit 31) is cleared before attempting to access the EEPROM, or change the function of the GPO/GPIO signals, or before modifying the ADDRH or ADDRRL registers in the MAC.

Note 3.3 HBI - "Host Bus Interface", NASR - Not affected by software reset.

3.11.1 Power-On Reset (POR)

A Power-On reset occurs whenever power is initially applied to the LAN89218, or if power is removed and reapplied to the LAN89218. A timer within the LAN89218 will assert the internal reset for a maximum of 25 ms after the supply voltage reaches the minimum operational voltage. The READY bit in the PMT_CTRL register can be read from the host interface and will read back a '0' until the POR is complete. Upon completion of the POR, the READY bit in PMT_CTRL is set high, and the LAN89218 can be configured via its control registers. Refer to [Section 7.2, "Operating Conditions**," on page 145](#) for details on the operational supply voltage range.

IMPORTANT NOTE: While the internal power-on reset circuit may assert during brown-out conditions, this is not guaranteed. For proper operation in applications where brown-outs may occur, use of an external reset circuit is recommended.

APPLICATION NOTE: Following deassertion of a power-on reset, the READY bit in PMT_CTRL will be set (high - "1") within 25 ms. If the software driver polls this bit and it is not set within 100ms, then an error condition occurred.

APPLICATION NOTE: In order for valid device configuration strap inputs to be read at power-on, the configuration strap input voltage levels must be stable and ready to be read (latched) within 15 ms (typical) of the deassertion of POR reset. Device configuration straps are also latched as a result of nRESET assertion. Refer to [Section 6.8, "nRESET Timing," on page 143](#) and [Section 3.11, "Detailed Reset Description," on page 52](#) for additional details.

3.11.2 Hardware Reset Input (nRESET)

A hardware reset will occur when the nRESET input signal is driven low. The READY bit in the PMT_CTRL register can be read from the host interface, and will read back a '0' until the hardware reset is complete. Upon completion of the hardware reset, the READY bit in PMT_CTRL is set high.

After the "READY" bit is set, the LAN89218 can be configured via its control registers. The nRESET signal is pulled-high internally by the LAN89218 and can be left unconnected if unused. If used, nRESET must be driven low for a minimum period as defined in [Section 6.8, "nRESET Timing," on page 143](#).

IMPORTANT NOTE: For proper operation in applications where brown-outs may occur, use of an external reset circuit is recommended.

APPLICATION NOTE: Following deassertion of a hardware reset, the READY bit in PMT_CTRL will be set (high - "1") immediately. If the software driver polls this bit and it is not set within 100 ms, then an error condition occurred.

3.11.3 Soft Reset (SRST)

Soft reset is initiated by writing a '1' to bit 0 of the HW_CFG register (SRST). This self-clearing bit will return to '0' after approximately 2 μ s, at which time the Soft Reset is complete. Soft reset does not clear control register bits marked as NASR.

APPLICATION NOTE: Following deassertion of a soft reset, the READY bit in PMT_CTRL will be set (high - "1") within 2 μ s. If the software driver polls this bit and it is not set within 100 ms, then an error condition occurred.

3.11.4 PHY Reset Timing

The following sections specify the operation and time required for the internal PHY to become operational after various resets or when returning from the reduced power state.

3.11.4.1 PHY Soft Reset via PMT_CTRL bit 10 (PHY_RST)

The PHY soft reset is initiated by writing a '1' to bit 10 of the PMT_CTRL register (PHY_RST). This self-clearing bit will return to '0' after approximately 100 μ s, at which time the PHY reset is complete.

3.11.4.2 PHY Soft Reset via PHY Basic Control Register (PHY Reg. 0.15)

The PHY Reg. 0.15 Soft Reset is initiated by writing a '1' to bit 15 of the PHY's Basic Control Register. This self-clearing bit will return to '0' at which time the PHY reset is complete.

3.12 TX Data Path Operation

Data is queued for transmission by writing it into the TX data FIFO. Each packet to be transmitted may be divided among multiple buffers. Each buffer starts with a two DWORD TX command (TX command 'A' and TX command 'B'). The TX command instructs the LAN89218 on the handling of the associated buffer. Packet boundaries are delineated using control bits within the TX command.

The host provides a 16-bit Packet Tag field in the TX command. The Packet Tag value is appended to the corresponding TX status DWORD. All Packet Tag fields must have the same value for all buffers in a given packet. If tags differ between buffers in the same packet the TXE error will be asserted. Any value may be chosen for a Packet Tag as long as all tags in the same Packet are identical. Packet Tags also provide a method of synchronization between transmitted packets and their associated status. Software can use unique Packet Tags to assist with validating matching status completions.

Note: The use of packet tags is not required by the hardware. This is a software LAN driver only application example for use of this field.

A Packet Length field in the TX command specifies the number of bytes in the associated packet. All Packet Length fields must have the same value for all buffers in a given packet. Hardware compares the Packet Length field and the actual amount of data received by the Ethernet controller. If the actual packet length count does not match the Packet Length field as defined in the TX command, the Transmitter Error (TXE) flag is asserted.

The LAN89218 can be programmed to start payload transmission of a buffer on a byte boundary by setting the "Data Start Offset" field in the TX command. The "Data Start Offset" field points to the actual start of the payload data within the first 8 DWORDs of the buffer. Data before the "Data Start Offset" pointer will be ignored. When a packet is split into multiple buffers, each successive buffer may begin on any arbitrary byte.

The LAN89218 can be programmed to strip padding from the end of a transmit packet in the event that the end of the packet does not align with the host burst boundary. This feature is necessary when the LAN89218 is operating in a system that always performs multi-word bursts. In such cases the LAN89218 must guarantee that it can accept data in multiples of the Burst length regardless of the actual packet length. When configured to do so, the LAN89218 will accept extra data at the end of the packet and will remove the extra padding before transmitting the packet. The LAN89218 automatically removes data up to the boundary specified in the Buffer End Alignment field specified in each TX command.

The host can instruct the LAN89218 to issue an interrupt when the buffer has been fully loaded into the TX FIFO contained in the LAN89218 and transmitted. This feature is enabled through the TX command 'Interrupt on Completion' field.

Upon completion of transmission, irrespective of success or failure, the status of the transmission is written to the TX status FIFO. TX status is available to the host and may be read using PIO operations. An interrupt can be optionally enabled by the host to indicate the availability of a programmable number TX status DWORDS.

Before writing the TX command and payload data to the TX FIFO, the host must check the available TX FIFO space by performing a PIO read of the TX_FIFO_INF register. The host must ensure that it does not overflow the TX FIFO or the TX Error (TXE) flag will be asserted.

The host proceeds to write the TX command by first writing TX command 'A', then TX command 'B'. After writing the command, the host can then move the payload data into the TX FIFO. TX status DWORD's are stored in the TX status FIFO to be read by the host at a later time upon completion of the data transmission onto the wire.

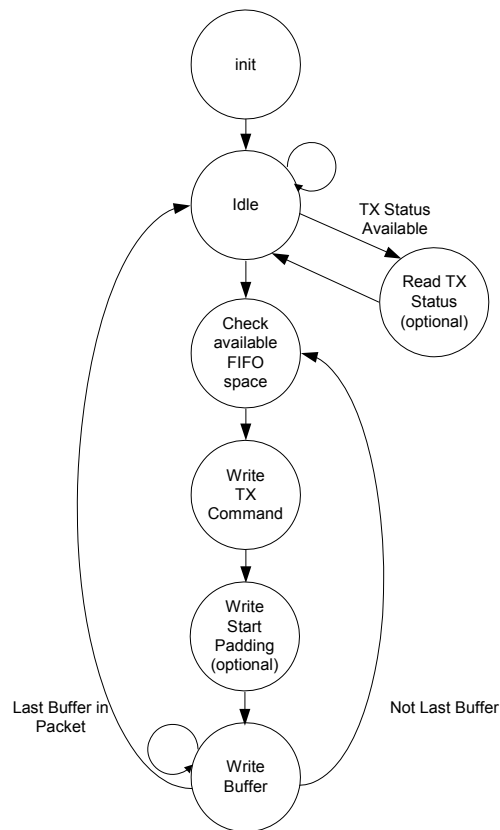

Figure 3.20 Simplified Host TX Flow Diagram

3.12.1 TX Buffer Format

TX buffers exist in the host's memory in a given format. The host writes a TX command word into the TX data buffer before moving the Ethernet packet data. The TX command A and command B are 32-bit values that are used by the LAN89218 in the handling and processing of the associated Ethernet packet data buffer. Buffer alignment, segmentation and other packet processing parameters are included in the command structure. The following diagram illustrates the buffer format.

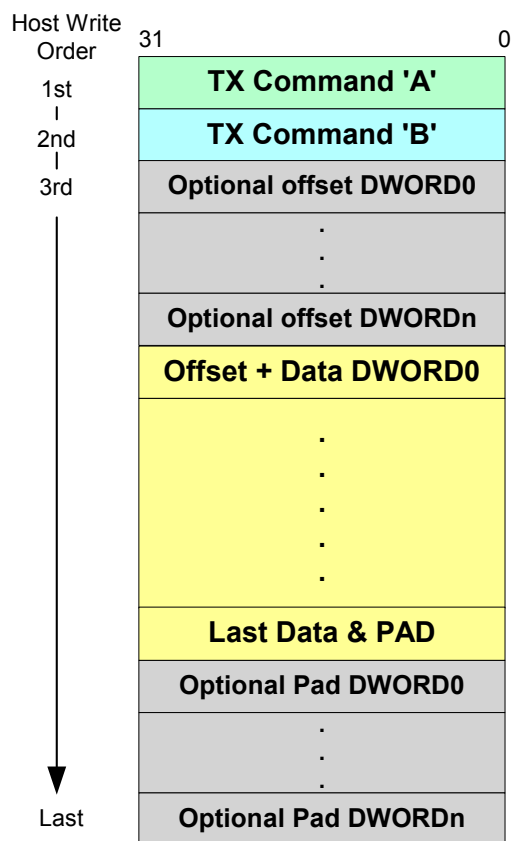

Figure 3.21 TX Buffer Format

Figure 3.21, "TX Buffer Format", shows the TX Buffer as it is written into the LAN89218. It should be noted that not all of the data shown in this diagram is actually stored in the TX data FIFO. This must be taken into account when calculating the actual TX data FIFO usage. Refer to [Section 3.12.5, "Calculating Actual TX Data FIFO Usage,"](#) on page 61 for a detailed explanation on calculating the actual TX data FIFO usage.

3.12.2 TX Command Format

The TX command instructs the TX FIFO controller on handling the subsequent buffer. The command precedes the data to be transmitted. The TX command is divided into two, 32-bit words; TX command 'A' and TX command 'B'.

There is a 16-bit packet tag in the TX command 'B' command word. Packet tags may, if host software desires, be unique for each packet (i.e., an incrementing count). The value of the tag will be returned in the RX status word for the associated packet. The Packet tag can be used by host software to uniquely identify each status word as it is returned to the host.

Both TX command 'A' and TX command 'B' are required for each buffer in a given packet. TX command 'B' must be identical for every buffer in a given packet. If the TX command 'B' words do not match, the Ethernet controller will assert the Transmitter Error (TXE) flag.

3.12.2.1 TX Command 'A'

Table 3.13 TX Command 'A' Format

BITS	DESCRIPTION															
31	Interrupt on Completion. When set, the TXDONE flag will be asserted when the current buffer has been fully loaded into the TX FIFO. This flag may be optionally mapped to a host interrupt.															
30:26	Reserved. These bits are reserved. Always write zeros to this field to guarantee future compatibility.															
25:24	<p>Buffer End Alignment. This field specifies the alignment that must be maintained on the last data transfer of a buffer. The host will add extra DWORDs of data up to the alignment specified in the table below. The LAN89218 will remove the extra DWORDs. This mechanism can be used to maintain cache line alignment on host processors.</p> <table border="1" style="margin-left: auto; margin-right: auto;"> <thead> <tr> <th>[25]</th> <th>[24]</th> <th>End Alignment</th> </tr> </thead> <tbody> <tr> <td>0</td> <td>0</td> <td>4-byte alignment</td> </tr> <tr> <td>0</td> <td>1</td> <td>16-byte alignment</td> </tr> <tr> <td>1</td> <td>0</td> <td>32-byte alignment</td> </tr> <tr> <td>1</td> <td>1</td> <td>Reserved</td> </tr> </tbody> </table>	[25]	[24]	End Alignment	0	0	4-byte alignment	0	1	16-byte alignment	1	0	32-byte alignment	1	1	Reserved
[25]	[24]	End Alignment														
0	0	4-byte alignment														
0	1	16-byte alignment														
1	0	32-byte alignment														
1	1	Reserved														
23:21	Reserved. These bits are reserved. Always write zeros to this field to guarantee future compatibility															
20:16	Data Start Offset (bytes). This field specifies the offset of the first byte of TX data. The offset value can be anywhere from 0 bytes to 31 a Byte offset.															
15:14	Reserved. These bits are reserved. Always write zeros to this field to guarantee future compatibility															
13	First Segment (FS). When set, this bit indicates that the associated buffer is the first segment of the packet.															
12	Last Segment. When set, this bit indicates that the associated buffer is the last segment of the packet															
11	Reserved. These bits are reserved. Always write zeros to this field to guarantee future compatibility.															

Table 3.13 TX Command 'A' Format (continued)

BITS	DESCRIPTION
10:0	<p>Buffer Size (bytes). This field indicates the number of bytes contained in the buffer following this command. This value, along with the Buffer End Alignment field, is read and checked by the LAN89218 and used to determine how many extra DWORD's were added to the end of the Buffer. A running count is also maintained in the LAN89218 of the cumulative buffer sizes for a given packet. This cumulative value is compared against the Packet Length field in the TX command 'B' word and if they do not correlate, the TXE flag is set.</p> <p>Note: The buffer size specified does not include the buffer end alignment padding or data start offset added to a buffer.</p>

3.12.2.2 TX Command 'B'**Table 3.14 TX Command 'B' Format**

BITS	DESCRIPTION
31:16	<p>Packet Tag. The host should write a unique packet identifier to this field. This identifier is added to the corresponding TX status word and can be used by the host to correlate TX status words with their corresponding packets.</p> <p>Note: The use of packet tags is not required by the hardware. This field can be used by the LAN software driver for any application. Packet Tags is one application example.</p>
15	<p>Reserved. This bit is reserved. Always write zeros to this bit to guarantee future compatibility.</p>
14	<p>TX Checksum Enable (CK). When this bit is set in conjunction with the first segment (FS) bit in TX Command 'A' and the TX checksum offload engine enable bit (TXCOE_EN) in the COE_CR—Checksum Offload Engine Control Register, the TX checksum offload engine (TXCOE) will calculate a L3 checksum for the associated frame.</p>
13	<p>Add CRC Disable. When set, the automatic addition of the CRC is disabled.</p>
12	<p>Disable Ethernet Frame Padding. When set, this bit prevents the automatic addition of padding to an Ethernet frame of less than 64 bytes. The CRC field is also added despite the state of the Add CRC Disable field.</p>
11	<p>Reserved. These bits are reserved. Always write zeros to this field to guarantee future compatibility.</p>
10:0	<p>Packet Length (bytes). This field indicates the total number of bytes in the current packet. This length does not include the offset or padding. If the Packet Length field does not match the actual number of bytes in the packet the Transmitter Error (TXE) flag will be set.</p>

3.12.3 TX Data Format

The TX data section begins at the third DWORD in the TX buffer (after TX command 'A' and TX command 'B'). The location of the first byte of valid buffer data to be transmitted is specified in the "Data Start Offset" field of the TX command 'A' word. [Table 3.15, "TX DATA Start Offset"](#), shows the correlation between the setting of the LSB's in the "Data Start Offset" field and the byte location of the first valid data byte. Additionally, transmit buffer data can be offset by up to 7 additional DWORDS as indicated by the upper three MSB's (5:2) in the "Data Start Offset" field.

Table 3.15 TX DATA Start Offset

Data Start Offset [1:0]:	11	10	01	00
First TX Data Byte:	D[31:24]	D[23:16]	D[15:8]	D[7:0]

TX data is contiguous until the end of the buffer. The buffer may end on a byte boundary. Unused bytes at the end of the packet will not be sent to the MIL for transmission.

The Buffer End Alignment field in TX command 'A' specifies the alignment that must be maintained for the associated buffer. End alignment may be specified as 4-, 16-, or 32-byte. The host processor is responsible for adding the additional data to the end of the buffer. The hardware will automatically remove this extra data.

3.12.3.1 TX Buffer Fragmentation Rules

Transmit buffers must adhere to the following rules:

- Each buffer can start and end on any arbitrary byte alignment
- The first buffer of any transmit packet can be any length
- Middle buffers (i.e., those with First Segment = Last Segment = 0) must be greater than, or equal to 4 bytes in length
- The final buffer of any transmit packet can be any length

The MIL operates in store-and-forward mode and has specific rules with respect to fragmented packets. The total space consumed in the TX FIFO (MIL) must be limited to no more than 2KB - 3 DWORDS (2,036 bytes total). Any transmit packet that is so highly fragmented that it takes more space than this must be un-fragmented (by copying to a driver-supplied buffer) before the transmit packet can be sent to the LAN89218.

One approach to determine whether a packet is too fragmented is to calculate the actual amount of space that it will consume, and check it against 2,036 bytes. Another approach is to check the number of buffers against a worst-case limit of 86 (see explanation below).

3.12.3.2 Calculating Worst-Case TX FIFO (MIL) Usage

The actual space consumed by a buffer in the MIL TX FIFO consists only of any partial DWORD offsets in the first/last DWORD of the buffer, plus all of the whole DWORDs in between. Any whole DWORD offsets and/or alignments are stripped off before the buffer is loaded into the TX Data FIFO, and TX command words are stripped off before the buffer is written to the MIL TX FIFO, so none of those DWORDs count as space consumed. The worst-case overhead for a TX buffer is 6 bytes, which assumes that it started on the high byte of a DWORD and ended on the low byte of a DWORD. A TX packet consisting of 86 such fragments would have an overhead of 516 bytes (6 * 86) which, when added to a 1514-byte max-size transmit packet (1516 bytes, rounded up to the next whole DWORD), would give a total space consumption of 2,032 bytes, leaving 4 bytes to spare; this is the basis for the "86 fragment" rule mentioned above.

3.12.4 TX Status Format

TX status is passed to the host CPU through a separate FIFO mechanism. A status word is returned for each packet transmitted. Data transmission is suspended if the TX status FIFO becomes full. Data transmission will resume when the host reads the TX status and there is room in the FIFO for more “TX Status” data.

The host can optionally choose to not read the TX status. The host can optionally ignore the TX status by setting the “TX Status Discard Allow Overrun Enable” (TXSAO) bit in the TX Configuration Register (TX_CFG). If this option is chosen TX status will not be written to the FIFO. Setting this bit high allows the transmitter to continue operation with a full TX status FIFO. In this mode the status information is still available in the TX status FIFO, and TX status interrupts still function. In the case of an overrun, the TXSUSED counter will stay at zero and no further TX status will be written to the TX status FIFO until the host frees space by reading TX status. If TXSAO is enabled, a TXE error will not be generated if the TX status FIFO overruns. In this mode the host is responsible for re-synchronizing TX status in the case of an overrun.

BITS	DESCRIPTION
31:16	Packet TAG. Unique identifier written by the host into the Packet Tag field of the TX command ‘B’ word. This field can be used by the host to correlate TX status words with the associated TX packets.
15	Error Status (ES). When set, this bit indicates that the Ethernet controller has reported an error. This bit is the logical OR of bits 11, 10, 9, 8, 2, 1 in this status word.
14:12	Reserved. These bits are reserved. Always write zeros to this field to guarantee future compatibility.
11	Loss of Carrier. When set, this bit indicates the loss of carrier during transmission.
10	No Carrier. When set, this bit indicates that the carrier signal from the transceiver was not present during transmission. Note: During 10/100 Mbps full-duplex transmission, the value of this bit is invalid and should be ignored.
9	Late Collision. When set, indicates that the packet transmission was aborted after the collision window of 64 bytes.
8	Excessive Collisions. When set, this bit indicates that the transmission was aborted after 16 collisions while attempting to transmit the current packet.
7	Reserved. This bit is reserved. Always write zeros to this field to guarantee future compatibility.
6:3	Collision Count. This counter indicates the number of collisions that occurred before the packet was transmitted. It is not valid when excessive collisions (bit 8) is also set.
2	Excessive Deferral. If the deferred bit is set in the control register, the setting of the excessive deferral bit indicates that the transmission has ended because of a deferral of over 24288 bit times during transmission.
1	Reserved. This bit is reserved. Always write zero to this bit to guarantee future compatibility.
0	Deferred. When set, this bit indicates that the current packet transmission was deferred.

3.12.5 Calculating Actual TX Data FIFO Usage

The following rules are used to calculate the actual TX data FIFO space consumed by a TX Packet:

- TX command 'A' is stored in the TX data FIFO for every TX buffer
- TX command 'B' is written into the TX data FIFO when the First Segment (FS) bit is set in TX command 'A'
- When TX checksum is enabled, the 4-byte TX checksum preamble is written into TX Data FIFO.
- Any DWORD-long data added as part of the “Data Start Offset” is removed from each buffer before the data is written to the TX data FIFO. Any data that is less than 1 DWORD is passed to the TX data FIFO.
- Payload from each buffer within a Packet is written into the TX data FIFO.
- Any DWORD-long data added as part of the End Padding is removed from each buffer before the data is written to the TX data FIFO. Any end padding that is less than 1 DWORD is passed to the TX data FIFO

3.12.6 Transmit Examples

3.12.6.1 TX Example 1

In this example a single, 111-Byte Ethernet packet will be transmitted. This packet is divided into three buffers. The three buffers are as follows:

Buffer 0:

- 7-Byte “Data Start Offset”
- 79-Bytes of payload data
- 16-Byte “Buffer End Alignment”

Buffer 1:

- 0-Byte “Data Start Offset”
- 15-Bytes of payload data
- 16-Byte “Buffer End Alignment”

Buffer 2:

- 10-Byte “Data Start Offset”
- 17-Bytes of payload data
- 16-Byte “Buffer End Alignment”

Figure 3.22, "TX Example 1" illustrates the TX command structure for this example, and also shows how data is passed to the TX data FIFO.

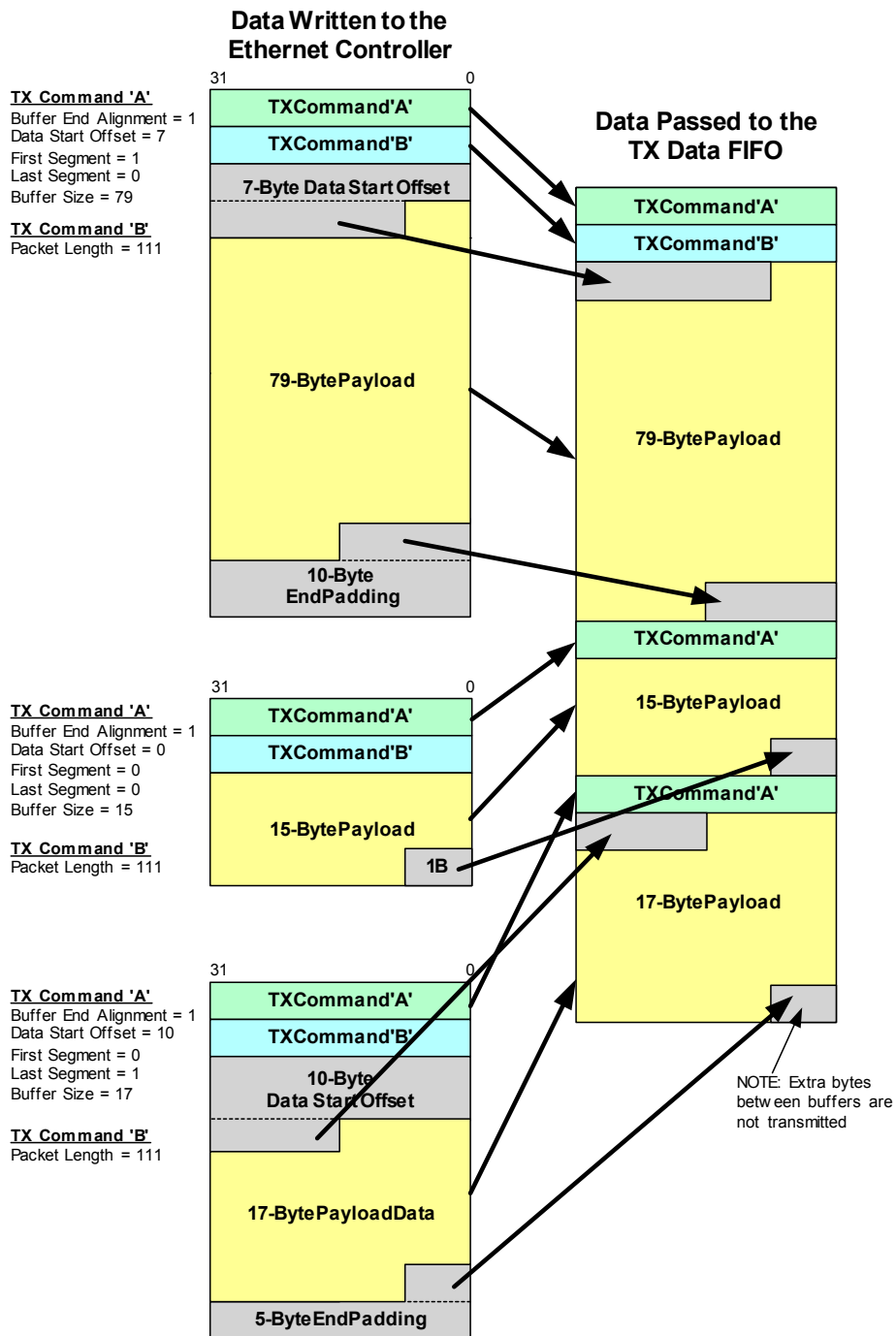

Figure 3.22 TX Example 1

3.12.6.2 TX Example 2

In this example, a single 183-Byte Ethernet packet will be transmitted. This packet is in a single buffer as follows:

- 2-Byte "Data Start Offset"
- 183-Bytes of payload data
- 4-Byte "Buffer End Alignment"

Figure 3.23, "TX Example 2" illustrates the TX command structure for this example, and also shows how data is passed to the TX data FIFO. Note that the packet resides in a single TX Buffer, therefore both the FS and LS bits are set in TX command 'A'.

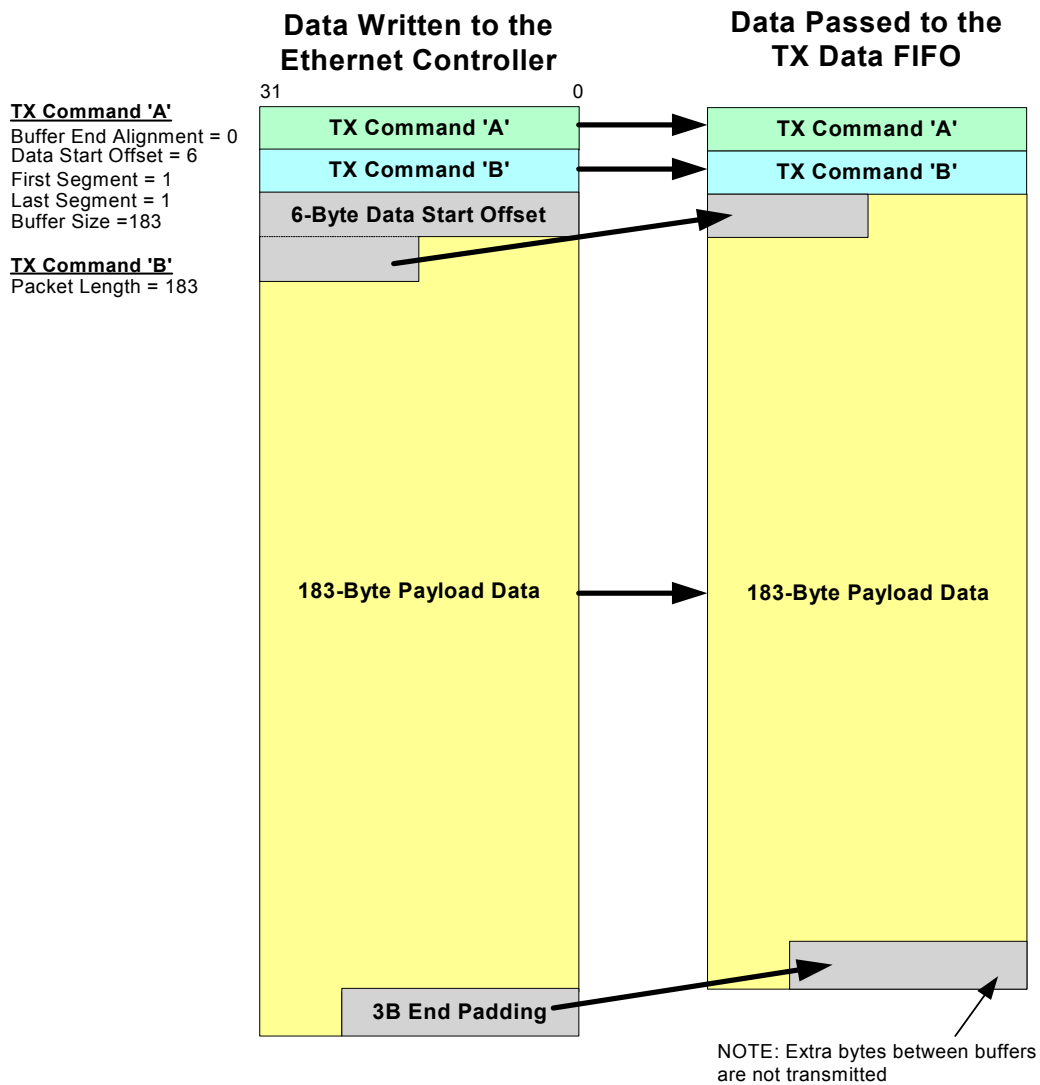

Figure 3.23 TX Example 2

3.12.6.3 TX Example 3

In this example a single, 111-Byte Ethernet packet will be transmitted with a TX checksum. This packet is divided into four buffers. The four buffers are as follows:

Buffer 0:

- 4-Byte "Data Start Offset"
- 4-Byte Checksum Preamble
- 16-Byte "Buffer End Alignment"

Buffer 1:

- 7-Byte "Data Start Offset"
- 79-Bytes of payload data
- 16-Byte "Buffer End Alignment"

Buffer 2:

- 0-Byte "Data Start Offset"
- 15-Bytes of payload data
- 16-Byte "Buffer End Alignment"

Buffer 3:

- 10-Byte "Data Start Offset"
- 17-Bytes of payload data
- 16-Byte "Buffer End Alignment"

Figure 3.22, "TX Example 1" illustrates the TX command structure for this example, and also shows how data is passed to the TX data FIFO.

Note: In order to perform a TX checksum calculation on the associated packet, bit 14 (CK) of the TX Command 'B' must be set in conjunction with bit 13 (FS) of TX Command 'A' and bit 16 (TXCOE_EN) of the COE_CR register. For more information, refer to [Section 3.6.2, "Transmit Checksum Offload Engine \(TXCOE\)"](#).

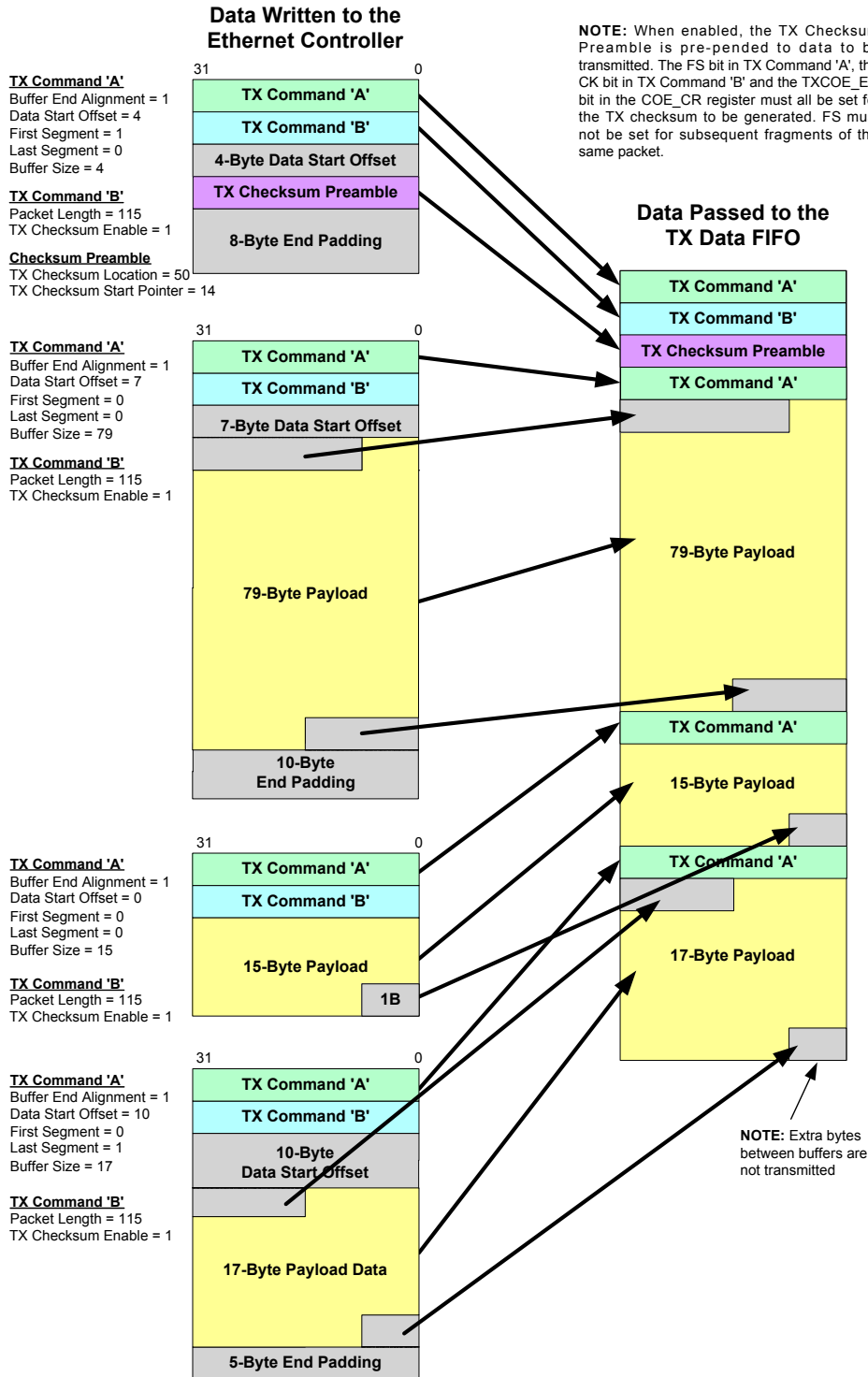

Figure 3.24 TX Example 3

3.12.7 Transmitter Errors

If the Transmitter Error (TXE) flag is asserted for any reason, the transmitter will continue operation. TX Error (TXE) will be asserted under the following conditions:

- If the actual packet length count does not match the Packet Length field as defined in the TX command.
- Both TX command 'A' and TX command 'B' are required for each buffer in a given packet. TX command 'B' must be identical for every buffer in a given packet. If the TX command 'B' words do not match, the Ethernet controller will assert the Transmitter Error (TXE) flag.
- Host overrun of the TX data FIFO.
- Overrun of the TX status FIFO (unless TXSAO is enabled)

3.12.8 Stopping and Starting the Transmitter

To halt the transmitter, the host must set the TX_STOP bit in the TX_CFG register. The transmitter will finish sending the current frame (if there is a frame transmission in progress). When the transmitter has received the TX status for this frame, it will clear the TX_STOP and TX_ON bits, and will pulse the TXSTOP_INT.

Once stopped, the host can optionally clear the TX status and TX data FIFOs. The host must re-enable the transmitter by setting the TX_ON bit. If there are frames pending in the TX data FIFO (i.e., TX data FIFO was not purged), the transmission will resume with this data.

3.13 RX Data Path Operation

When an Ethernet Packet is received, the MIL first begins to transfer the RX data. This data is loaded into the RX data FIFO. The RX data FIFO pointers are updated as data is written into the FIFO.

The last transfer from the MIL is the RX status word. The LAN89218 implements a separate FIFO for the RX status words. The total available RX data and status queued in the RX FIFO can be read from the RX_FIFO_INF register. The host may read any number of available RX status words before reading the RX data FIFO.

The host must use caution when reading the RX data and status. The host must never read more data than what is available in the FIFOs. If this is attempted an underrun condition will occur. If this error occurs, the Ethernet controller will assert the Receiver Error (RXE) interrupt. If an underrun condition occurs, a soft reset is required to regain host synchronization.

A configurable beginning offset is supported in the LAN89218. The RX data Offset field in the RX_CFG register controls the number of bytes that the beginning of the RX data buffer is shifted. The host can set an offset from 0-31 bytes. The offset may be changed in between RX packets, but it must not be changed during an RX packet read.

The LAN89218 can be programmed to add padding at the end of a receive packet in the event that the end of the packet does not align with the host burst boundary. This feature is necessary when the LAN89218 is operating in a system that always performs multi-DWORD bursts. In such cases the LAN89218 must guarantee that it can transfer data in multiples of the Burst length regardless of the actual packet length. When configured to do so, the LAN89218 will add extra data at the end of the packet to allow the host to perform the necessary number of reads so that the Burst length is not cut short. Once a packet has been padded by the H/W, it is the responsibility of the host to interrogate the Packet length field in the RX status and determine how much padding to discard at the end of the Packet.

It is possible to read multiple packets out of the RX data FIFO in one continuous stream. It should be noted that the programmed Offset and Padding will be added to each individual packet in the stream, since packet boundaries are maintained.

3.13.1 RX Slave PIO Operation

Using PIO mode, the host can either implement a polling or interrupt scheme to empty the received packet out of the RX data FIFO. The host will remain in the idle state until it receives an indication (interrupt or polling) that data is available in the RX data FIFO. The host will then read the RX status FIFO to get the packet status, which will contain the packet length and any other status information. The host should perform the proper number of reads, as indicated by the packet length plus the start offset and the amount of optional padding added to the end of the frame, from the RX data FIFO.

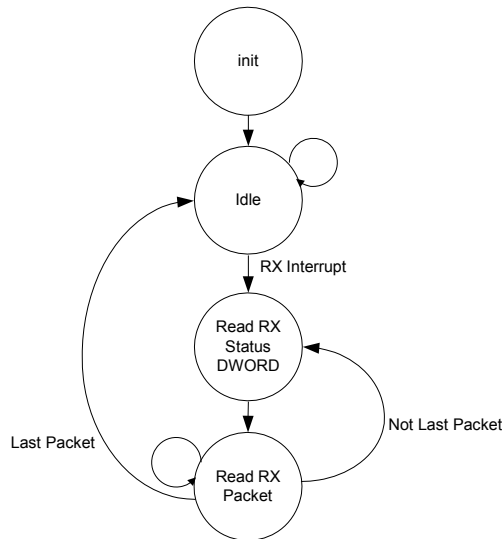

Figure 3.25 Host Receive Routine Using Interrupts

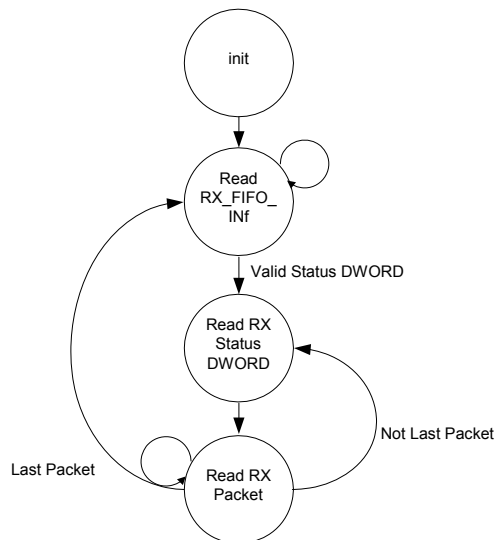

Figure 3.26 Host Receive Routine with Polling

3.13.1.1 Receive Data FIFO Fast Forward

The RX data path implements an automatic data discard function. Using the RX data FIFO Fast Forward bit (RX_FFWD) in the RX_DP_CTRL register, the host can instruct the LAN89218 to skip the packet at the head of the RX data FIFO. The RX data FIFO pointers are automatically incremented to the beginning of the next RX packet.

When performing a fast-forward, there must be at least 4 DWORDs of data in the RX data FIFO for the packet being discarded. For less than 4 DWORDs do not use RX_FFWD. In this case data must be read from the RX data FIFO and discarded using standard PIO read operations.

After initiating a fast-forward operation, do not perform any reads of the RX data FIFO until the RX_FFWD bit is cleared. Other resources can be accessed during this time (i.e., any registers and/or the other three FIFOs). Also note that the RX_FFWD will only fast-forward the RX data FIFO, not the RX status FIFO.

The receiver does not have to be stopped to perform a fast-forward operation.

3.13.1.2 Force Receiver Discard (Receiver Dump)

In addition to the Receive data Fast Forward feature, LAN89218 also implements a receiver "dump" feature. This feature allows the host processor to flush the entire contents of the RX data and RX status FIFOs. When activated, the read and write pointers for the RX data and status FIFOs will be returned to their reset state. To perform a receiver dump, the LAN89218 receiver must be halted. Once the receiver stop completion is confirmed, the RX_DUMP bit can be set in the RX_CFG register. The RX_DUMP bit is cleared when the dump is complete. For more information on stopping the receiver, refer to [Section 3.13.4, "Stopping and Starting the Receiver," on page 71](#). For more information on the RX_DUMP bit, refer to [Section 5.3.7, "RX_CFG—Receive Configuration Register," on page 91](#).

3.13.2 RX Packet Format

The RX status words can be read from the RX status FIFO port, while the RX data packets can be read from the RX data FIFO. RX data packets are formatted in a specific manner before the host can read them as shown in Figure 3.27. It is assumed that the host has previously read the associated status word from the RX status FIFO, to ascertain the data size and any error conditions.

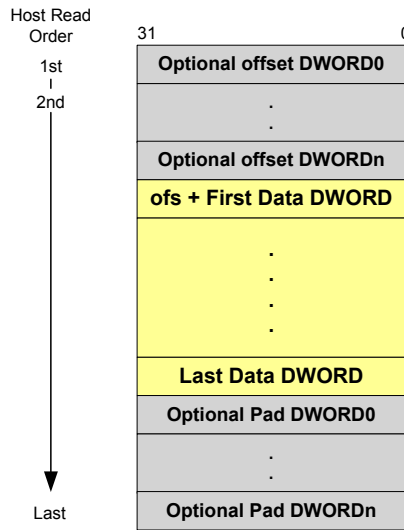

Figure 3.27 RX Packet Format

Figure 3.28 shows the RX packet format when the RX checksum is enabled. The RX checksum data appended to the data payload is treated just as an additional 4-bytes within the RX Data FIFO. The RX checksum is enabled by setting the RXCOE_EN bit in the COE_CR—Checksum Offload Engine Control Register. For more information on the RX checksum, refer to Section 3.6.1, "Receive Checksum Offload Engine (RXCOE)".

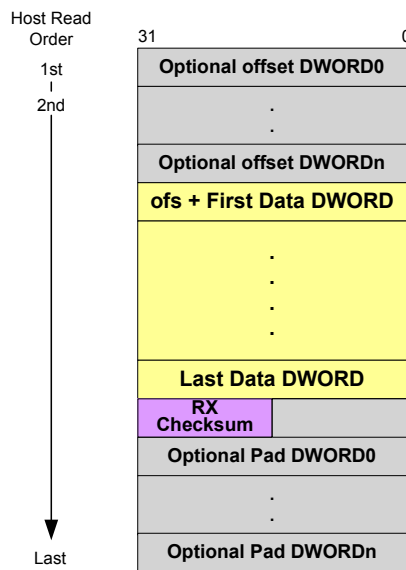

Figure 3.28 RX Packet Format with RX Checksum

3.13.3 RX Status Format

BITS	DESCRIPTION
31	Reserved. This bit is reserved. Reads 0.
30	Filtering Fail. When set, this bit indicates that the associated frame failed the address recognizing filtering.
29:16	Packet Length. The size, in bytes, of the corresponding received frame.
15	Error Status (ES). When set this bit indicates that the MIL has reported an error. This bit is the Internal logical "or" of bits 11,7,6 and 1.
14	Reserved. These bits are reserved. Reads 0.
13	Broadcast Frame. When set, this bit indicates that the received frame has a Broadcast address.
12	Length Error (LE). When set, this bit indicates that the actual length does not match with the length/type field of the received frame.
11	Runt Frame. When set, this bit indicates that frame was prematurely terminated before the collision window (64 bytes). Runt frames are passed on to the host only if the Pass Bad Frames bit MAC_CR Bit [16] is set.
10	Multicast Frame. When set, this bit indicates that the received frame has a Multicast address.
9:8	Reserved. These bits are reserved. Reads 0.
7	Frame Too Long. When set, this bit indicates that the frame length exceeds the maximum Ethernet specification of 1518 bytes. This is only a frame too long indication and will not cause the frame reception to be truncated.
6	Collision Seen. When set, this bit indicates that the frame has seen a collision after the collision window. This indicates that a late collision has occurred.
5	Frame Type. When set, this bit indicates that the frame is an Ethernet-type frame (Length/Type field in the frame is greater than 1500). When reset, it indicates the incoming frame was an 802.3 type frame. This bit is not set for Runt frames less than 14 bytes.
4	Receive Watchdog time-out. When set, this bit indicates that the incoming frame is greater than 2048 bytes through 2560 bytes, therefore expiring the Receive Watchdog Timer.
3	MII Error. When set, this bit indicates that a receive error (RX_ER asserted) was detected during frame reception.
2	Dribbling Bit. When set, this bit indicates that the frame contained a non-integer multiple of 8 bits. This error is reported only if the number of dribbling bits in the last byte is 4 in the MII operating mode, or at least 3 in the 10 Mbps operating mode. This bit will not be set when the collision seen bit[6] is set. If set and the CRC error bit[1] is cleared, then the packet is considered to be valid.
1	CRC Error. When set, this bit indicates that a CRC error was detected. This bit is also set when the RX_ER pin is asserted during the reception of a frame even though the CRC may be correct. This bit is not valid if the received frame is a Runt frame, or a late collision was detected or when the Watchdog Time-out occurs.
0	Reserved. These bits are reserved. Reads 0

3.13.4 Stopping and Starting the Receiver

To stop the receiver, the host must clear the RXEN bit in the MAC Control Register. When the receiver is halted, the RXSTOP_INT will be pulsed. Once stopped, the host can optionally clear the RX status and RX data FIFOs. The host must re-enable the receiver by setting the RXEN bit.

3.13.5 Receiver Errors

If the Receiver Error (RXE) flag is asserted for any reason, the receiver will continue operation. RX Error (RXE) will be asserted under the following conditions:

- A host underrun of RX data FIFO
- A host underrun of the RX status FIFO
- An overrun of the RX status FIFO

It is the duty of the host to identify and resolve any error conditions.

Chapter 4 Internal Ethernet PHY

4.1 Top Level Functional Description

Functionally, the internal PHY can be divided into the following sections:

- 100Base-TX transmit and receive
- 10Base-T transmit and receive
- Internal MII interface to the Ethernet Media Access Controller
- Auto-negotiation to automatically determine the best speed and duplex possible
- Management Control to read status registers and write control registers

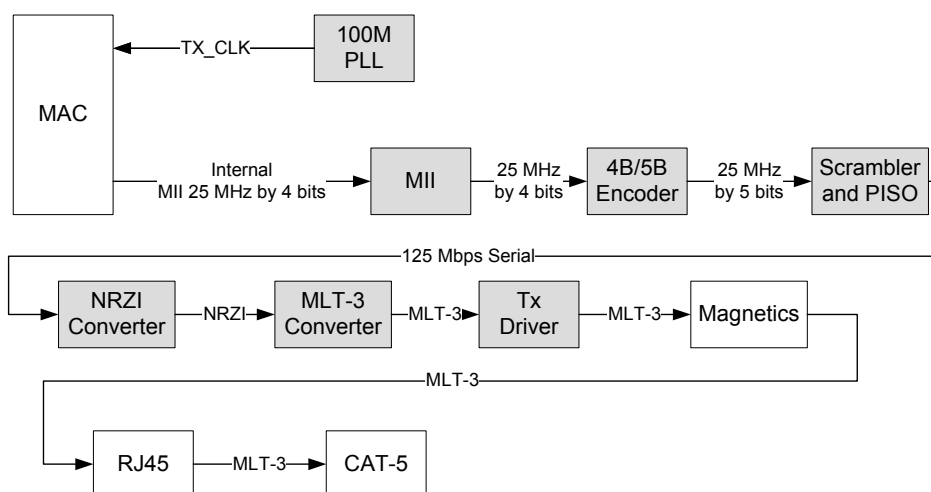

Figure 4.1 100Base-TX Data Path

4.2 100Base-TX Transmit

The data path of the 100Base-TX is shown in [Figure 4.1](#). Each major block is explained below.

4.2.1 4B/5B Encoding

The transmit data passes from the MII block to the 4B/5B encoder. This block encodes the data from 4-bit nibbles to 5-bit symbols (known as “code-groups”) according to [Table 4.1](#). Each 4-bit data-nibble is mapped to 16 of the 32 possible code-groups. The remaining 16 code-groups are either used for control information or are not valid.

The first 16 code-groups are referred to by the hexadecimal values of their corresponding data nibbles, 0 through F. The remaining code-groups are given letter designations with slashes on either side. For example, an IDLE code-group is //, a transmit error code-group is /H/, etc.

The encoding process may be bypassed by clearing bit 6 of register 31. When the encoding is bypassed the 5th transmit data bit is equivalent to TX_ER.

Table 4.1 4B/5B Code Table

CODE GROUP	SYM	RECEIVER INTERPRETATION			TRANSMITTER INTERPRETATION		
11110	0	0	0000	DATA	0	0000	DATA
01001	1	1	0001		1	0001	
10100	2	2	0010		2	0010	
10101	3	3	0011		3	0011	
01010	4	4	0100		4	0100	
01011	5	5	0101		5	0101	
01110	6	6	0110		6	0110	
01111	7	7	0111		7	0111	
10010	8	8	1000		8	1000	
10011	9	9	1001		9	1001	
10110	A	A	1010		A	1010	
10111	B	B	1011		B	1011	
11010	C	C	1100		C	1100	
11011	D	D	1101		D	1101	
11100	E	E	1110		E	1110	
11101	F	F	1111		F	1111	
11111	I	IDLE			Sent after /T/R until TX_EN		
11000	J	First nibble of SSD, translated to "0101" following IDLE, else RX_ER			Sent for rising TX_EN		
10001	K	Second nibble of SSD, translated to "0101" following J, else RX_ER			Sent for rising TX_EN		
01101	T	First nibble of ESD, causes de-assertion of CRS if followed by /R/, else assertion of RX_ER			Sent for falling TX_EN		
00111	R	Second nibble of ESD, causes deassertion of CRS if following /T/, else assertion of RX_ER			Sent for falling TX_EN		
00100	H	Transmit Error Symbol			Sent for rising TX_ER		
00110	V	INVALID, RX_ER if during RX_DV			INVALID		
11001	V	INVALID, RX_ER if during RX_DV			INVALID		
00000	V	INVALID, RX_ER if during RX_DV			INVALID		
00001	V	INVALID, RX_ER if during RX_DV			INVALID		
00010	V	INVALID, RX_ER if during RX_DV			INVALID		

Table 4.1 4B/5B Code Table (continued)

CODE GROUP	SYM	RECEIVER INTERPRETATION	TRANSMITTER INTERPRETATION
00011	V	INVALID, RX_ER if during RX_DV	INVALID
00101	V	INVALID, RX_ER if during RX_DV	INVALID
01000	V	INVALID, RX_ER if during RX_DV	INVALID
01100	V	INVALID, RX_ER if during RX_DV	INVALID
10000	V	INVALID, RX_ER if during RX_DV	INVALID

4.2.2 Scrambling

Repeated data patterns (especially the IDLE code-group) can have power spectral densities with large narrow-band peaks. Scrambling the data helps eliminate these peaks and spread the signal power more uniformly over the entire channel bandwidth. This uniform spectral density is required by FCC regulations to prevent excessive EMI from being radiated by the physical wiring.

The scrambler also performs the Parallel In Serial Out conversion (PISO) of the data.

4.2.3 NRZI and MLT3 Encoding

The scrambler block passes the 5-bit wide parallel data to the NRZI converter where it becomes a serial 125MHz NRZI data stream. The NRZI is encoded to MLT-3. MLT3 is a tri-level code where a change in the logic level represents a code bit "1" and the logic output remaining at the same level represents a code bit "0".

4.2.4 100M Transmit Driver

The MLT3 data is then passed to the analog transmitter, which launches the differential MLT-3 signal, on outputs TXP and TXN, to the twisted pair media via a 1:1 ratio isolation transformer. The 10Base-T and 100Base-TX signals pass through the same transformer so that common "magnetics" can be used for both. The transmitter drives into the 100 Ω impedance of the CAT-5 cable. Cable termination and impedance matching require external components.

4.2.5 100M Phase Lock Loop (PLL)

The 100M PLL locks onto reference clock and generates the 125 MHz clock used to drive the 125 MHz logic and the 100Base-Tx Transmitter.

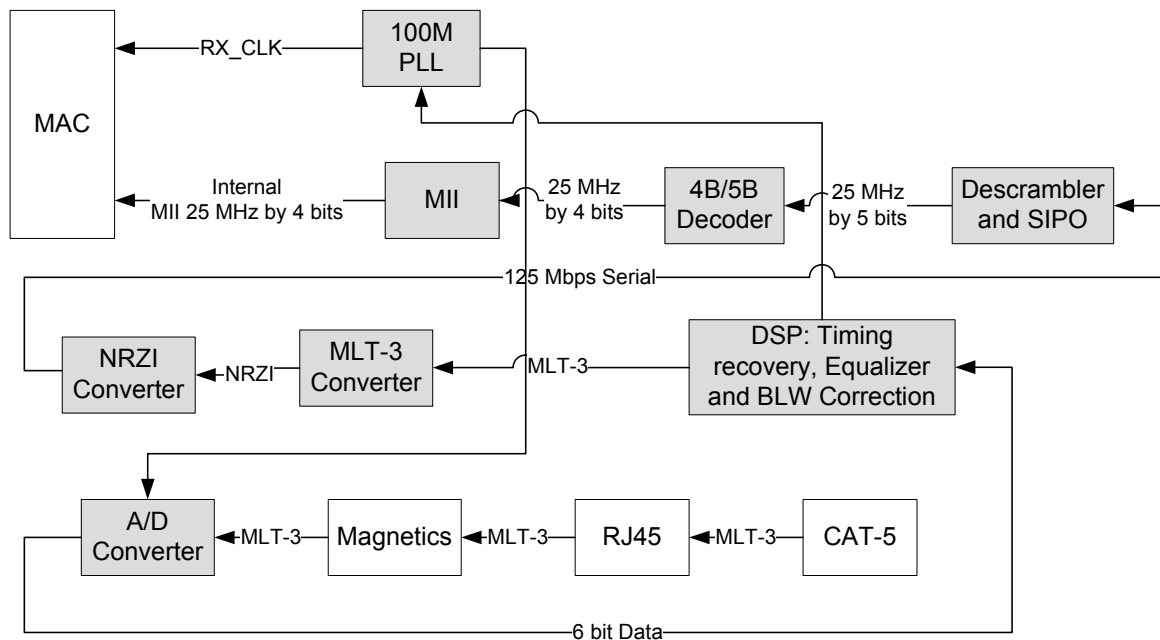

Figure 4.2 Receive Data Path

4.3 100Base-TX Receive

The receive data path is shown in [Figure 4.2](#). Detailed descriptions are given below.

4.3.1 100M Receive Input

The MLT-3 from the cable is fed into the PHY (on inputs RXP and RXN) via a 1:1 ratio transformer. The ADC samples the incoming differential signal at a rate of 125M samples per second. Using a 64-level quantizer it generates 6 digital bits to represent each sample. The DSP adjusts the gain of the ADC according to the observed signal levels such that the full dynamic range of the ADC can be used.

4.3.2 Equalizer, Baseline Wander Correction and Clock and Data Recovery

The 6 bits from the ADC are fed into the DSP block. The equalizer in the DSP section compensates for phase and amplitude distortion caused by the physical channel consisting of magnetics, connectors, and CAT-5 cable. The equalizer can restore the signal for any good-quality CAT-5 cable between 1 m and 150 m.

If the DC content of the signal is such that the low-frequency components fall below the low frequency pole of the isolation transformer, then the droop characteristics of the transformer will become significant and Baseline Wander (BLW) on the received signal will result. To prevent corruption of the received data, the PHY corrects for BLW and can receive the ANSI X3.263-1995 FDDI TP-PMD defined "killer packet" with no bit errors.

The 100M PLL generates multiple phases of the 125 MHz clock. A multiplexer, controlled by the timing unit of the DSP, selects the optimum phase for sampling the data. This is used as the received recovered clock. This clock is used to extract the serial data from the received signal.

4.3.3 NRZI and MLT-3 Decoding

The DSP generates the MLT-3 recovered levels that are fed to the MLT-3 converter. The MLT-3 is then converted to an NRZI data stream.

4.3.4 Descrambling

The descrambler performs an inverse function to the scrambler in the transmitter and also performs the Serial In Parallel Out (SIPO) conversion of the data.

During reception of IDLE (*//*) symbols, the descrambler synchronizes its descrambler key to the incoming stream. Once synchronization is achieved, the descrambler locks on this key and is able to descramble incoming data.

Special logic in the descrambler ensures synchronization with the remote PHY by searching for IDLE symbols within a window of 4000 bytes (40 μ s). This window ensures that a maximum packet size of 1514 bytes, allowed by the IEEE 802.3 standard, can be received with no interference. If no IDLE-symbols are detected within this time-period, receive operation is aborted and the descrambler re-starts the synchronization process.

The descrambler can be bypassed by setting bit 0 of register 31.

4.3.5 Alignment

The de-scrambled signal is then aligned into 5-bit code-groups by recognizing the */J/K/* Start-of-Stream Delimiter (SSD) pair at the start of a packet. Once the code-word alignment is determined, it is stored and utilized until the next start of frame.

4.3.6 5B/4B Decoding

The 5-bit code-groups are translated into 4-bit data nibbles according to the 4B/5B table. The SSD, */J/K/*, is translated to "0101 0101" as the first 2 nibbles of the MAC preamble. Reception of the SSD causes the PHY to assert the internal RX_DV signal, indicating that valid data is available on the Internal RXD bus. Successive valid code-groups are translated to data nibbles. Reception of either the End of Stream Delimiter (ESD) consisting of the */T/R/* symbols, or at least two *//* symbols causes the PHY to de-assert the internal carrier sense and RX_DV.

These symbols are not translated into data.

4.4 10Base-T Transmit

Data to be transmitted comes from the MAC layer controller. The 10Base-T transmitter receives 4-bit nibbles from the MII at a rate of 2.5 MHz and converts them to a 10 Mbps serial data stream. The data stream is then Manchester-encoded and sent to the analog transmitter, which drives a signal onto the twisted pair via the external magnetics.

The 10M transmitter uses the following blocks:

- MII (digital)
- TX 10M (digital)
- 10M Transmitter (analog)
- 10M PLL (analog)

4.4.1 10M Transmit Data Across the Internal MII Bus

The MAC controller drives the transmit data onto the internal TXD BUS. When the controller has driven TX_EN high to indicate valid data, the data is latched by the MII block on the rising edge of TX_CLK. The data is in the form of 4-bit wide 2.5 MHz data.

4.4.2 Manchester Encoding

The 4-bit wide data is sent to the TX10M block. The nibbles are converted to a 10Mbps serial NRZI data stream. The 10M PLL locks onto the external clock or internal oscillator and produces a 20 MHz clock. This is used to Manchester encode the NRZ data stream. When no data is being transmitted (TX_EN is low), the TX10M block outputs Normal Link Pulses (NLPs) to maintain communications with the remote link partner.

4.4.3 10M Transmit Drivers

The Manchester encoded data is sent to the analog transmitter where it is shaped and filtered before being driven out as a differential signal across the TXP and TXN outputs.

4.5 10Base-T Receive

The 10Base-T receiver gets the Manchester- encoded analog signal from the cable via the magnetics. It recovers the receive clock from the signal and uses this clock to recover the NRZI data stream. This 10M serial data is converted to 4-bit data nibbles which are passed to the controller across the MII at a rate of 2.5 MHz.

This 10M receiver uses the following blocks:

- Filter and SQUELCH (analog)
- 10M PLL (analog)
- RX 10M (digital)
- MII (digital)

4.5.1 10M Receive Input and Squelch

The Manchester signal from the cable is fed into the PHY (on inputs RXP and RXN) via 1:1 ratio magnetics. It is first filtered to reduce any out-of-band noise. It then passes through a SQUELCH circuit. The SQUELCH is a set of amplitude and timing comparators that normally reject differential voltage levels below 300 mV and detect and recognize differential voltages above 585 mV.

4.5.2 Manchester Decoding

The output of the SQUELCH goes to the RX10M block where it is validated as Manchester encoded data. The polarity of the signal is also checked. If the polarity is reversed (local RXP is connected to RXN of the remote partner and vice versa), then this is identified and corrected. The reversed condition is indicated by the flag "XPOL", bit 4 in register 27. The 10M PLL is locked onto the received Manchester signal and from this, generates the received 20 MHz clock. Using this clock, the Manchester encoded data is extracted and converted to a 10 MHz NRZI data stream. It is then converted from serial to 4-bit wide parallel data.

The RX10M block also detects valid 10Base-T IDLE signals - Normal Link Pulses (NLPs) - to maintain the link.

4.5.3 Jabber Detection

Jabber is a condition in which a station transmits for a period of time longer than the maximum permissible packet length, usually due to a fault condition, that results in holding the TX_EN input for a long period. Special logic is used to detect the jabber state and abort the transmission to the line, within 45 ms. Once TX_EN is deasserted, the logic resets the jabber condition.

4.6 Auto-Negotiation

The purpose of the Auto-negotiation function is to automatically configure the PHY to the optimum link parameters based on the capabilities of its link partner. Auto-negotiation is a mechanism for exchanging configuration information between two link-partners and automatically selecting the highest performance mode of operation supported by both sides. Auto-negotiation is fully defined in clause 28 of the IEEE 802.3 specification.

Once auto-negotiation has completed, information about the resolved link can be passed back to the controller via the internal Serial Management Interface (SMI). The results of the negotiation process are reflected in the Speed Indication bits in register 31, as well as the Link Partner Ability Register (Register 5).

The auto-negotiation protocol is a purely physical layer activity and proceeds independently of the MAC controller.

The advertised capabilities of the PHY are stored in register 4 of the SMI registers. The default advertised by the PHY is determined by user-defined on-chip signal options.

The following blocks are activated during an Auto-negotiation session:

- Auto-negotiation (digital)
- 100M ADC (analog)
- 100M PLL (analog)
- 100M equalizer/BLW/clock recovery (DSP)
- 10M SQUELCH (analog)
- 10M PLL (analog)
- 10M Transmitter (analog)

When enabled, auto-negotiation is started by the occurrence of one of the following events:

- Hardware reset
- Software reset
- Power-down reset
- Link status down
- Setting register 0, bit 9 high (auto-negotiation restart)

On detection of one of these events, the PHY begins auto-negotiation by transmitting bursts of Fast Link Pulses (FLP). These are bursts of link pulses from the 10M transmitter. They are shaped as Normal Link Pulses and can pass uncorrupted down CAT-3 or CAT-5 cable. A Fast Link Pulse Burst consists of up to 33 pulses. The 17 odd-numbered pulses, which are always present, frame the FLP burst. The 16 even-numbered pulses, which may be present or absent, contain the data word being transmitted. Presence of a data pulse represents a “1”, while absence represents a “0”.

The data transmitted by an FLP burst is known as a “Link Code Word.” These are defined fully in IEEE 802.3 clause 28. In summary, the PHY advertises 802.3 compliance in its selector field (the first 5 bits of the Link Code Word). It advertises its technology ability according to the bits set in register 4 of the SMI registers.

There are 4 possible matches of the technology abilities. In the order of priority these are:

- 100M full-duplex (Highest priority)
- 100M half-duplex
- 10M full-duplex
- 10M half-duplex

If the full capabilities of the PHY are advertised (100M, full-duplex), and if the link partner is capable of 10M and 100M, then auto-negotiation selects 100M as the highest performance mode. If the link partner is capable of half and full-duplex modes, then auto-negotiation selects full-duplex as the highest performance operation.

Once a capability match has been determined, the link code words are repeated with the acknowledge bit set. Any difference in the main content of the link code words at this time will cause auto-negotiation to re-start. Auto-negotiation will also re-start if not all of the required FLP bursts are received.

Writing register 4 bits [8:5] allows software control of the capabilities advertised by the PHY. Writing register 4 does not automatically re-start auto-negotiation. Register 0, bit 9 must be set before the new abilities will be advertised. Auto-negotiation can also be disabled via software by clearing register 0, bit 12.

The LAN89218 does not support “Next Page” capability.

4.7 Parallel Detection

If the LAN89218 is connected to a device lacking the ability to auto-negotiate (i.e. no FLPs are detected), it is able to determine the speed of the link based on either 100M MLT-3 symbols or 10M Normal Link Pulses. In this case the link is presumed to be half-duplex per the IEEE standard. This ability is known as “Parallel Detection. This feature ensures inter operability with legacy link partners. If a link is formed via parallel detection, then bit 0 in register 6 is cleared to indicate that the Link Partner is not capable of auto-negotiation. The Ethernet MAC has access to this information via the management interface. If a fault occurs during parallel detection, bit 4 of register 6 is set.

Register 5 is used to store the Link Partner Ability information, which is coded in the received FLPs. If the Link Partner is not auto-negotiation capable, then register 5 is updated after completion of parallel detection to reflect the speed capability of the Link Partner.

4.7.1 Re-starting Auto-Negotiation

Auto-negotiation can be re-started at any time by setting register 0, bit 9. Auto-negotiation will also re-start if the link is broken at any time. A broken link is caused by signal loss. This may occur because of a cable break, or because of an interruption in the signal transmitted by the Link Partner. Auto-negotiation resumes in an attempt to determine the new link configuration.

If the management entity re-starts Auto-negotiation by writing to bit 9 of the control register, the LAN89218 will respond by stopping all transmission/receiving operations. Once the `break_link_timer` is done, in the Auto-negotiation state-machine (approximately 1200 ms) the auto-negotiation will re-start. The Link Partner will have also dropped the link due to lack of a received signal, so it too will resume auto-negotiation.

4.7.2 Disabling Auto-Negotiation

Auto-negotiation can be disabled by setting register 0, bit 12 to zero. The device will then force its speed of operation to reflect the information in register 0, bit 13 (speed) and register 0, bit 8 (duplex). The speed and duplex bits in register 0 should be ignored when auto-negotiation is enabled.

4.7.3 Half vs. Full-Duplex

Half-duplex operation relies on the CSMA/CD (Carrier Sense Multiple Access / Collision Detect) protocol to handle network traffic and collisions. In this mode, the internal carrier sense signal, CRS, responds to both transmit and receive activity. In this mode, if data is received while the PHY is transmitting, a collision results.

In full-duplex mode, the PHY is able to transmit and receive data simultaneously. In this mode, the internal CRS responds only to receive activity. The CSMA/CD protocol does not apply and collision detection is disabled.

[Table 4.2](#) describes the behavior of the internal CRS bit under all receive/transmit conditions. The internal CRS signal is used to trigger bit 10 (No Carrier) of the TX Status word (See [Section 3.12.4, "TX Status Format"](#)). The CRS value, and subsequently the No Carrier value, are invalid during any full-duplex transmission. Therefore, these signals cannot be used as a verification method of transmitted packets when transmitting in 10/100 Mbps full-duplex modes.

Table 4.2 CRS Behavior

MODE	SPEED	DUPLEX	ACTIVITY	CRS BEHAVIOR (Note 4.1)
Manual	10 Mbps	Half-Duplex	Transmitting	Active
Manual	10 Mbps	Half-Duplex	Receiving	Active
Manual	10 Mbps	Full-Duplex	Transmitting	Low
Manual	10 Mbps	Full-Duplex	Receiving	Active
Manual	100 Mbps	Half-Duplex	Transmitting	Active
Manual	100 Mbps	Half-Duplex	Receiving	Active
Manual	100 Mbps	Full-Duplex	Transmitting	Low
Manual	100 Mbps	Full-Duplex	Receiving	Active
Auto-Negotiation	10 Mbps	Half-Duplex	Transmitting	Active
Auto-Negotiation	10 Mbps	Half-Duplex	Receiving	Active
Auto-Negotiation	10 Mbps	Full-Duplex	Transmitting	Low
Auto-Negotiation	10 Mbps	Full-Duplex	Receiving	Active
Auto-Negotiation	100 Mbps	Half-Duplex	Transmitting	Active
Auto-Negotiation	100 Mbps	Half-Duplex	Receiving	Active
Auto-Negotiation	100 Mbps	Full-Duplex	Transmitting	Low
Auto-Negotiation	100 Mbps	Full-Duplex	Receiving	Active

Note 4.1 The LAN89218 10/100 PHY internal CRS signal operates in two modes: Active and Low. When in Active mode, the internal CRS will transition high and low upon line activity, where a high value indicates a carrier has been detected. In Low mode, the internal CRS stays low and does not indicate carrier detection. The internal CRS signal and No Carrier (bit 10 of the TX Status word) cannot be used as a verification method of transmitted packets when transmitting in 10/100 Mbps full-duplex mode.

4.8 HP Auto-MDIX

HP Auto-MDIX facilitates the use of CAT-3 (10 Base-T) or CAT-5 (100 Base-T) media UTP interconnect cable without consideration of interface wiring scheme. If a user plugs in either a direct connect LAN cable, or a cross-over patch cable, as shown in Figure 4.3, the LAN89218 Auto-MDIX PHY is capable of configuring the TPO and TPI twisted pair pins for correct transceiver operation.

The internal logic of the device detects the TX and RX pins of the connecting device. Since the RX and TX line pairs are interchangeable, special PCB design considerations are needed to accommodate the symmetrical magnetics and termination of an Auto-MDIX design.

The Auto-MDIX function can be disabled through an internal register 27.15, or the external control pins AMDIX_EN. When disabled the TX and RX pins can be configured with the Channel Select (CH_SELECT) pin as desired.

The figure below shows the signal names at the RJ-45 connector, The mapping of these signals to the pins on the LAN89218 is as follows:

TXP = TPO+
 TXN = TPO-
 RXP = TPI+
 RXN = TPI-

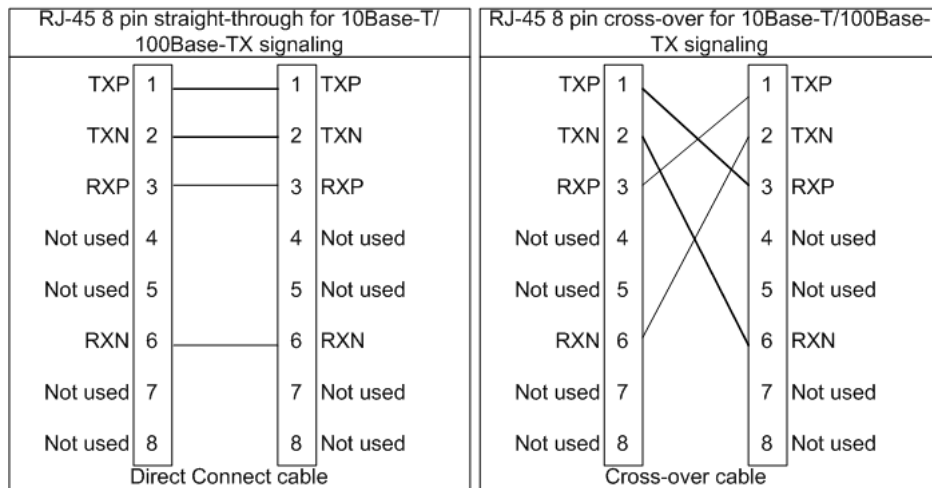

Figure 4.3 Direct Cable Connection vs. Cross-over Cable Connection

Chapter 5 Register Description

The following section describes all LAN89218 registers and data ports.

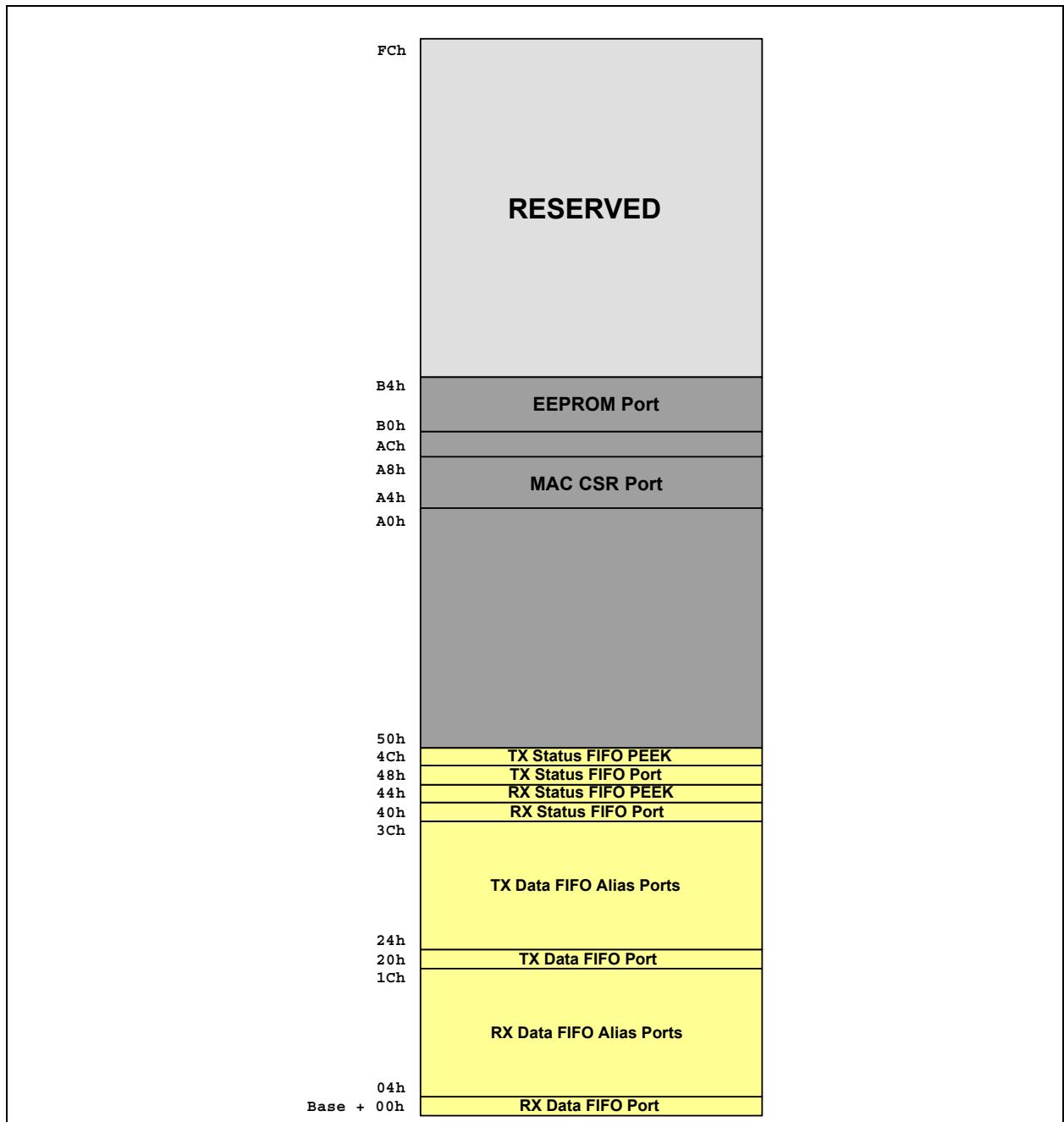

Figure 5.1 Memory Map

5.1 Register Nomenclature and Access Attributes

SYMBOL	DESCRIPTION
RO	Read Only: If a register is read only, writes to this register have no effect.
WO	Write Only: If a register is write only, reads always return 0.
R/W	Read/Write: A register with this attribute can be read and written
R/WC	Read/Write Clear: A register bit with this attribute can be read and written. However, a write of a 1 clears (sets to 0) the corresponding bit and a write of a 0 has no effect.
RC	Read to Clear: A register bit with this attribute is cleared when read.
LL	Latch Low: Clear on read of register
LH	Latch High: Clear on read of register
SC	Self-Clearing
NASR	Not Affected by Software Reset
Reserved Bits	Certain bits within registers are listed as "Reserved". Unless stated otherwise, these bits must be written with zeros for future compatibility. The values of these bits are not guaranteed when read.
Reserved Registers	Certain configuration registers within the LAN89218 are listed as "Reserved". These registers are not guaranteed to return any particular value when read. These registers must not be written to or modified by system failure; doing so could result in failure of the device and system.
Default States	At Reset - System reset, Software Reset, or POR - internal registers are set to their default states. The default states provide a minimum level of functionality needed to successfully bring up a system, but do not necessarily provide desired or optimal configuration of the device. It is the responsibility of the system initialization software to properly determine the operating parameters and optional system features that are applicable, and to program the LAN89218 registers accordingly.

5.2 RX and TX FIFO Ports

The LAN89218 contains four host-accessible FIFOs: RX Status, RX Data, TX Status, and TX Data FIFOs. The sizes Data FIFOs and the RX Status FIFO are configurable through the CSRs.

5.2.1 RX FIFO Ports

The RX Data Path contains two Read-Only FIFOs: RX Status and RX Data. The RX Status FIFO has two ports at different address locations. The RX Status FIFO Port causes the top of the RX Status FIFO to be "popped", and is destructive. The RX Status FIFO PEEK Port allows the top of the RX Status FIFO to be read without "popping" it.

The RX Data FIFO has a single port; reading data from this port always causes the top of the RX Data FIFO to be "popped". This port is aliased to 8 DWORD (in 32-bit mode) or 16 WORD locations (in 16-bit mode). The host may access the top of the RX Data FIFO through any of these locations.

5.2.2 TX FIFO Ports

The TX Data Path consists of two FIFOs, TX Status and RX Data. The TX Status FIFO also has two ports at different locations. When the TX Status FIFO Port is read, the top of the TX Status FIFO is popped. When the TX Status FIFO PEEK Port is read, the top of the TX Status FIFO is not popped.

The TX data FIFO is Write Only. It is aliased to 8 DWORD (in 32-bit mode) or 16 WORD locations (in 16-bit mode). The host may access the top of the TX Data FIFO through any of these locations.

5.3 System Control and Status Registers

Table 5.1, "Direct Address Register Map", lists the registers that are directly addressable by the host bus.

Table 5.1 Direct Address Register Map

CONTROL AND STATUS REGISTERS			
BASE ADDRESS + OFFSET	SYMBOL	REGISTER NAME	DEFAULT
50h	ID_REV	Chip ID and Revision.	See Page 85.
54h	IRQ_CFG	Main Interrupt Configuration	00000000h
58h	INT_STS	Interrupt Status	00000000h
5Ch	INT_EN	Interrupt Enable Register	00000000h
60h	RESERVED	Reserved for future use	-
64h	BYTE_TEST	Read-only byte order testing register	87654321h
68h	FIFO_INT	FIFO Level Interrupts	48000000h
6Ch	RX_CFG	Receive Configuration	00000000h
70h	TX_CFG	Transmit Configuration	00000000h
74h	HW_CFG	Hardware Configuration	00050000h
78h	RX_DP_CTL	RX Datapath Control	00000000h
7Ch	RX_FIFO_INF	Receive FIFO Information	00000000h
80h	TX_FIFO_INF	Transmit FIFO Information	00001200h
84h	PMT_CTRL	Power Management Control	00000000h
88h	GPIO_CFG	General Purpose IO Configuration	00000000h
8Ch	GPT_CFG	General Purpose Timer Configuration	0000FFFFh
90h	GPT_CNT	General Purpose Timer Count	0000FFFFh
94h	RESERVED	Reserved for future use	-
98h	WORD_SWAP	WORD SWAP Register	00000000h
9Ch	FREE_RUN	Free Run Counter	-

Table 5.1 Direct Address Register Map (continued)

CONTROL AND STATUS REGISTERS			
BASE ADDRESS + OFFSET	SYMBOL	REGISTER NAME	DEFAULT
A0h	RX_DROP	RX Dropped Frames Counter	00000000h
A4h	MAC_CSR_CMD	MAC CSR Synchronizer Command (MAC CSR's are indexed through this register)	00000000h
A8h	MAC_CSR_DATA	MAC CSR Synchronizer Data	00000000h
ACh	AFC_CFG	Automatic Flow Control Configuration	00000000h
B0h	E2P_CMD	EEPROM Command	00000000h
B4h	E2P_DATA	EEPROM Data	00000000h
B8h - FCh	RESERVED	Reserved for future use	-

5.3.1 ID_REV—Chip ID and Revision

Offset: 50h Size: 32 bits

This register contains the ID and Revision fields for this design.

BITS	DESCRIPTION	TYPE	DEFAULT
31:16	Chip ID. This read-only field identifies this design	RO	218Ah
15:0	Chip Revision	RO	Note 5.1

Note 5.1 Default value is dependant on device revision.

5.3.2 IRQ_CFG—Interrupt Configuration Register

Offset: 54h Size: 32 bits

This register configures and indicates the state of the IRQ signal.

BITS	DESCRIPTION	TYPE	DEFAULT
31:24	<p>Interrupt Deassertion Interval (INT_DEAS). This field determines the Interrupt Request Deassertion Interval in multiples of 10 μs.</p> <p>Setting this field to zero causes the device to disable the INT_DEAS Interval, reset the interval counter, and issue any pending interrupts. If a new, non-zero value is written to this field, any subsequent interrupts will obey the new setting.</p> <p>Note: This field does not apply to the PME interrupt.</p>	R/W	0
23:15	Reserved	RO	-
14	<p>Interrupt Deassertion Interval Clear (INT_DEAS_CLR). Writing a one to this register clears the de-assertion counter in the IRQ Controller, thus causing a new de-assertion interval to begin (regardless of whether or not the IRQ Controller is currently in an active de-assertion interval).</p>	SC	0
13	<p>Interrupt Deassertion Status (INT_DEAS_STS). When set, this bit indicates that interrupts are currently in a deassertion interval, and will not be delivered to the IRQ pin. When this bit is clear, interrupts are not currently in a deassertion interval, and will be delivered to the IRQ pin.</p>	SC	0
12	<p>Master Interrupt (IRQ_INT). This read-only bit indicates the state of the internal IRQ line, regardless of the setting of the IRQ_EN bit, or the state of the interrupt de-assertion function. When this bit is high, one of the enabled interrupts is currently active.</p>	RO	0
11:9	Reserved	RO	-
8	<p>IRQ Enable (IRQ_EN) – This bit controls the final interrupt output to the IRQ pin. When clear, the IRQ output is disabled and permanently deasserted. This bit has no effect on any internal interrupt status bits.</p>	R/W	0
7:5	Reserved	RO	-
4	<p>IRQ Polarity (IRQ_POL) – When cleared, enables the IRQ line to function as an active low output. When set, the IRQ output is active high. When IRQ is configured as an open-drain output this field is ignored, and the interrupt output is always active low.</p>	R/W NASR	0
3:1	Reserved	RO	-
0	<p>IRQ Buffer Type (IRQ_TYPE) – When cleared, enables IRQ to function as an open-drain buffer for use in a Wired-Or Interrupt configuration. When set, the IRQ output is a Push-Pull driver. When configured as an open-drain output the IRQ_POL field is ignored, and the interrupt output is always active low.</p>	R/W NASR	0

5.3.3 INT_STS—Interrupt Status Register

Offset: 58h Size: 32 bits

This register contains the current status of the generated interrupts. Writing a 1 to the corresponding bits acknowledges and clears the interrupt.

BITS	DESCRIPTION	TYPE	DEFAULT
31	Software Interrupt (SW_INT) . This interrupt is generated when the SW_INT_EN bit is set high. Writing a one clears this interrupt.	R/WC	0
30:26	Reserved	RO	-
25	TX Stopped (TXSTOP_INT) . This interrupt is issued when STOP_TX bit in TX_CFG is set, and the transmitter is halted.	R/WC	0
24	RX Stopped (RXSTOP_INT) . This interrupt is issued when the receiver is halted.	R/WC	0
23	RX Dropped Frame Counter Halfway (RXDFH_INT) . This interrupt is issued when the RX Dropped Frames Counter counts past its halfway point (7FFFFFFh to 8000000h).	R/WC	0
22	Reserved	RO	0
21	TX IOC Interrupt (TX_IOC) . When a buffer with the IOC flag set has finished being loaded into the TX FIFO, this interrupt is generated.	R/WC	0
20	RX DMA Interrupt (RXD_INT) . This interrupt is issued when the amount of data programmed in the RX DMA Count (RX_DMA_CNT) field of the RX_CFG register has been transferred out of the RX FIFO.	R/WC	0
19	GP Timer (GPT_INT) . This interrupt is issued when the General Purpose timer wraps past zero to FFFFh.	R/WC	0
18	PHY (PHY_INT) . Indicates a PHY Interrupt event.	RO	0
17	Power Management Event Interrupt (PME_INT) . This interrupt is issued when a Power Management Event is detected as configured in the PMT_CTRL register. This interrupt functions independent of the PME signal, and will still function if the PME signal is disabled. Writing a '1' clears this bit regardless of the state of the PME hardware signal. Notes: <ul style="list-style-type: none"> ■ Detection of a Power Management Event, and assertion of the PME signal will not wakeup the LAN89218. The LAN89218 will only wake up when it detects a host write cycle of any data to the BYTE_TEST register. ■ The Interrupt Deassertion interval does not apply to the PME interrupt. 	R/WC	0
16	TX Status FIFO Overflow (TXSO) . Generated when the TX Status FIFO overflows.	R/WC	0
15	Receive Watchdog Time-out (RWT) . Interrupt is generated when a packet larger than 2048 bytes has been received.	R/WC	0
14	Receiver Error (RXE) . Indicates that the receiver has encountered an error. Refer to Section 3.13.5, "Receiver Errors," on page 71 for a description of the conditions that will cause an RXE.	R/WC	0

BITS	DESCRIPTION	TYPE	DEFAULT
13	Transmitter Error (TXE). When generated, indicates that the transmitter has encountered an error. Refer to Section 3.12.7, "Transmitter Errors," on page 66, for a description of the conditions that will cause a TXE.	R/WC	0
12:11	Reserved	RO	-
10	TX Data FIFO Overrun Interrupt (TDFO). Generated when the TX data FIFO is full, and another write is attempted.	R/WC	0
9	TX Data FIFO Available Interrupt (TDFA). Generated when the TX data FIFO available space is greater than the programmed level.	R/WC	0
8	TX Status FIFO Full Interrupt (TSFF). Generated when the TX Status FIFO is full.	R/WC	0
7	TX Status FIFO Level Interrupt (TSFL). Generated when the TX Status FIFO reaches the programmed level.	R/WC	0
6	RX Dropped Frame Interrupt (RXDF_INT). This interrupt is issued whenever a receive frame is dropped.	R/WC	0
5	Reserved	RO	-
4	RX Status FIFO Full Interrupt (RSFF). Generated when the RX Status FIFO is full.	R/WC	0
3	RX Status FIFO Level Interrupt (RSFL). Generated when the RX Status FIFO reaches the programmed level.	R/WC	0
2:0	GPIO [2:0] (GPIOx_INT). Interrupts are generated from the GPIO's. These interrupts are configured through the GPIO_CFG register.	R/WC	000

5.3.4 INT_EN—Interrupt Enable Register

Offset: 5Ch Size: 32 bits

This register contains the interrupt masks for IRQ. Writing 1 to any of the bits enables the corresponding interrupt as a source for IRQ. Bits in the INT_STS register will still reflect the status of the interrupt source regardless of whether the source is enabled as an interrupt in this register.

BITS	DESCRIPTION	TYPE	DEFAULT
31	Software Interrupt (SW_INT_EN)	R/W	0
30:26	Reserved	RO	-
25	TX Stopped Interrupt Enable (TXSTOP_INT_EN)	R/W	0
24	RX Stopped Interrupt Enable (RXSTOP_INT_EN)	R/W	0
23	RX Dropped Frame Counter Halfway Interrupt Enable (RXDFH_INT_EN).	R/W	0
22	Reserved	RO	0
21	TX IOC Interrupt Enable (TIOC_INT_EN)	R/W	0
20	RX DMA Interrupt (RXD_INT).	R/W	0
19	GP Timer (GPT_INT_EN)	R/W	0
18	PHY (PHY_INT_EN)	R/W	0
17	Power Management Event Interrupt Enable (PME_INT_EN)	R/W	0
16	TX Status FIFO Overflow (TXSO_EN)	R/W	0
15	Receive Watchdog Time-out Interrupt (RWT_INT_EN)	R/W	0
14	Receiver Error Interrupt (RXE_INT_EN)	R/W	0
13	Transmitter Error Interrupt (TXE_INT_EN)	R/W	0
12:11	Reserved	RO	-
10	TX Data FIFO Overrun Interrupt (TDFO_INT_EN)	R/W	0
9	TX Data FIFO Available Interrupt (TDFA_INT_EN)	R/W	0
8	TX Status FIFO Full Interrupt (TSFF_INT_EN)	R/W	0
7	TX Status FIFO Level Interrupt (TSFL_INT_EN)	R/W	0
6	RX Dropped Frame Interrupt Enable (RXDF_INT_EN)	R/W	0
5	Reserved	RO	-
4	RX Status FIFO Full Interrupt (RSFF_INT_EN)	R/W	0
3	RX Status FIFO Level Interrupt (RSFL_INT_EN)	R/W	0
2:0	GPIO [2:0] (GPIOx_INT_EN)	R/W	000

5.3.5 BYTE_TEST—Byte Order Test Register

Offset: 64h Size: 32 bits

This register can be used to determine the byte ordering of the current configuration

BITS	DESCRIPTION	TYPE	DEFAULT
31:0	Byte Test	RO	87654321h

5.3.6 FIFO_INT—FIFO Level Interrupts

Offset: 68h Size: 32 bits

This register configures the limits where the FIFO Controllers will generate system interrupts.

BITS	DESCRIPTION	TYPE	DEFAULT
31:24	TX Data Available Level. The value in this field sets the level, in number of 64 Byte blocks, at which the TX FIFO Available interrupt (TFDA) will be generated. When the TX data FIFO free space is greater than this value a TX FIFO Available interrupt (TDFA) will be generated.	R/W	48h
23:16	TX Status Level. The value in this field sets the level, in number of DWORDS, at which the TX Status FIFO Level interrupt (TSFL) will be generated. When the TX Status FIFO used space is greater than this value an TX Status FIFO Level interrupt (TSFL) will be generated.	R/W	00h
15:8	Reserved	RO	-
7:0	RX Status Level. The value in this field sets the level, in number of DWORDS, at which the RX Status FIFO Level interrupt (RSFL) will be generated. When the RX Status FIFO used space is greater than this value an RX Status FIFO Level interrupt (RSFL) will be generated.	R/W	00h

5.3.7 RX_CFG—Receive Configuration Register

Offset: 6Ch Size: 32 bits

This register controls the LAN89218 receive engine.

BITS	DESCRIPTION	TYPE	DEFAULT
31:30	<p>RX End Alignment. This field specifies the alignment that must be maintained on the last data transfer of a buffer. The LAN89218 will add extra DWORDs of data up to the alignment specified in the table below. The host is responsible for removing these extra DWORDs. This mechanism can be used to maintain cache line alignment on host processors.</p> <p>Refer to Table 5.2 for bit definitions</p> <p>Note: The desired RX End Alignment must be set before reading a packet. The RX end alignment can be changed between reading receive packets, but must not be changed if the packet is partially read.</p>	R/W	00b
29:28	Reserved	RO	-
27:16	<p>RX DMA Count (RX_DMA_CNT). This 12-bit field indicates the amount of data, in DWORDS, to be transferred out of the RX data FIFO before asserting the RXD_INT. After being set, this field is decremented for each DWORD of data that is read from the RX data FIFO. This field can be overwritten with a new value before it reaches zero.</p>	R/W	000h
15	<p>Force RX Discard (RX_DUMP). This self-clearing bit clears the RX data and status FIFOs of all pending data. When a '1' is written, the RX data and status pointers are cleared to zero.</p> <p>Note: Refer to section "Force Receiver Discard (Receiver Dump)" on page 68 for a detailed description regarding the use of RX_DUMP.</p>	SC	0
14:13	Reserved	RO	-
12:8	<p>RX Data Offset (RXDOFF). This field controls the offset value, in bytes, that is added to the beginning of an RX data packet. The start of the valid data will be shifted by the number of bytes specified in this field. An offset of 0-31 bytes is a valid number of offset bytes.</p> <p>Note: The two LSBs of this field (D[9:8]) must not be modified while the RX is running. The receiver must be halted, and all data purged before these two bits can be modified. The upper three bits (DWORD offset) may be modified while the receiver is running. Modifications to the upper bits will take effect on the next DWORD read.</p>	R/W	00000
7:0	Reserved	RO	-

Table 5.2 RX Alignment Bit Definitions

[31]	[30]	End Alignment
0	0	4-byte alignment
0	1	16-byte alignment
1	0	32-byte alignment
1	1	Reserved

5.3.8 TX_CFG—Transmit Configuration Register

Offset: 70h Size: 32 bits

This register controls the transmit functions on the LAN89218 Ethernet Controller.

BITS	DESCRIPTION	TYPE	DEFAULT
31:16	Reserved	RO	-
15	Force TX Status Discard (TXS_DUMP) . This self-clearing bit clears the TX status FIFO of all pending status DWORD's. When a '1' is written, the TX status pointers are cleared to zero.	SC	0
14	Force TX Data Discard (TXD_DUMP) . This self-clearing bit clears the TX data FIFO of all pending data. When a '1' is written, the TX data pointers are cleared to zero.	SC	0
13:3	Reserved	RO	-
2	TX Status Allow Overrun (TXSAO) . When this bit is cleared, data transmission is suspended if the TX Status FIFO becomes full. Setting this bit high allows the transmitter to continue operation with a full TX Status FIFO. Note: This bit does not affect the operation of the TX Status FIFO Full interrupt.	R/W	0
1	Transmitter Enable (TX_ON) . When this bit is set (1), the transmitter is enabled. Any data in the TX FIFO will be sent. This bit is cleared automatically when STOP_TX is set and the transmitter is halted.	R/W	0
0	Stop Transmitter (STOP_TX) . When this bit is set (1), the transmitter will finish the current frame, and will then stop transmitting. When the transmitter has stopped this bit will clear. All writes to this bit are ignored while this bit is high.	SC	0

5.3.9 HW_CFG—Hardware Configuration Register

Offset: 74h Size: 32 bits

Note: The transmitter and receiver must be stopped before writing to this register. Refer to [Section 3.12.8, "Stopping and Starting the Transmitter," on page 66](#) and [Section 3.13.4, "Stopping and Starting the Receiver," on page 71](#) for details on stopping the transmitter and receiver.

BITS	DESCRIPTION	TYPE	DEFAULT
31:25	Reserved	RO	-
24	AMDIX_EN Strap State. This read-only bit reflects the state of the AMDIX_EN strap pin (pin 73). This pin can be overridden by PHY Registers 27.15 and 27.13.	RO	AMDIX Strap Pin
23:21	Reserved	RO	
20	Must Be One (MBO). This bit must be set to "1" for normal device operation.	R/W	0
19:16	TX FIFO Size (TX_FIF_SZ). Sets the size of the TX FIFOs in 1 kB values to a maximum of 14 kB. The TX Status FIFO consumes 512 bytes of the space allocated by TX_FIF_SZ, and the TX data FIFO consumes the remaining space specified by TX_FIF_SZ. The minimum size of the TX FIFOs is 2 kB (TX data and status combined). The TX data FIFO is used for both TX data and TX commands. The RX status and data FIFOs consume the remaining space, which is equal to 16 kB – TX_FIF_SZ. See Section 5.3.9.1, "Allowable Settings for Configurable FIFO Memory Allocation," on page 94 for more information.	R/W	5h
15:3	Reserved	RO	-
2	32/16-bit Mode. When set, the LAN89218 is set for 32-bit operation. When clear, it is configured for 16-bit operation. This field is the value of the D32/nD16 strap.	RO	-
1	Soft Reset Time-out (SRST_TO). If a software reset is attempted when the internal PHY is not in the operational state (RX_CLK and TX_CLK running), the reset will not complete and the soft reset operation will time-out and this bit will be set to a '1'. The host processor must correct the problem and issue another soft reset.	RO	0
0	Soft Reset (SRST). Writing 1 generates a software initiated reset. This reset generates a full reset of the MAC CSR's. The SCSR's (system command and status registers) are reset except for any NASR bits. Soft reset also clears any TX or RX errors (TXE/RXE). This bit is self-clearing. Notes: <ul style="list-style-type: none"> ■ Do not attempt a soft reset unless the internal PHY is fully awake and operational. After a PHY reset, or when returning from a reduced power state, the PHY must be given adequate time to return to the operational state before a soft reset can be issued. The internal RX_CLK and TX_CLK signals must be running for a proper software reset. Refer to Section 6.8, "nRESET Timing," on page 143 for details on PHY reset timing. ■ The LAN89218 must always be read at least once after power-up, reset, or upon return from a power-saving state or write operations will not function. 	SC	0

5.3.9.1 Allowable Settings for Configurable FIFO Memory Allocation

TX and RX FIFO space is configurable through the CSR - HW_CFG register defined above. The user must select the FIFO allocation by setting the TX FIFO Size (TX_FIF_SZ) field in the hardware configuration (HW_CFG) register. The TX_FIF_SZ field selects the total allocation for the TX data path, including the TX Status FIFO size. The TX Status FIFO size is fixed at 512 Bytes (128 TX Status DWORDs). The TX Status FIFO length is subtracted from the total TX FIFO size with the remainder being the TX data FIFO Size. Note that TX data FIFO space includes both commands and payload data.

RX FIFO Size is the remainder of the unallocated FIFO space (16384 bytes – TX FIFO Size). The RX Status FIFO size is always equal to 1/16 of the RX FIFO Size. The RX Status FIFO length is subtracted from the total RX FIFO size with the remainder being the RX data FIFO Size.

For example, if TX_FIF_SZ = 6 then:

Total TX FIFO Size = 6144 Bytes (6KB)

TX Status FIFO Size = 512 Bytes (Fixed)

TX Data FIFO Size = 6144 – 512 = 5632 Bytes

RX FIFO Size = 16384 – 6144 = 10240 Bytes (10KB)

RX Status FIFO Size = 10240 / 16 = 640 Bytes (160 RX Status DWORDs)

RX Data FIFO Size = 10240 – 640 = 9600 Bytes

Table 5.3 shows every valid setting for the TX_FIF_SZ field. Note that settings not shown in this table are reserved and should not be used.

Note: The RX data FIFO is considered full 4 DWORDs before the length that is specified in the HW_CFG register.

Table 5.3 Valid TX/RX FIFO Allocations

TX_FIF_SZ	TX DATA FIFO SIZE (BYTES)	TX STATUS FIFO SIZE (BYTES)	RX DATA FIFO SIZE (BYTES)	RX STATUS FIFO SIZE (BYTES)
2	1536	512	13440	896
3	2560	512	12480	832
4	3584	512	11520	768
5	4608	512	10560	704
6	5632	512	9600	640
7	6656	512	8640	576
8	7680	512	7680	512
9	8704	512	6720	448
10	9728	512	5760	384
11	10752	512	4800	320
12	11776	512	3840	256

Table 5.3 Valid TX/RX FIFO Allocations (continued)

13	12800	512	2880	192
14	13824	512	1920	128

In addition to the host-accessible FIFOs, the MAC Interface Layer (MIL) contains an additional 2 kbytes of TX, and 128 bytes of RX FIFO buffering. These sizes are fixed, and cannot be adjusted by the host.

As space in the TX MIL (Mac Interface Layer) FIFO frees, data is moved into it from the TX data FIFO. Depending on the size of the frames to be transmitted, the MIL can hold up to two Ethernet frames. This is in addition to any TX data that may be queued in the TX data FIFO.

Conversely, as data is received by the LAN89218, it is moved from the MAC to the RX MIL FIFO, and then into the RX data FIFO. When the RX data FIFO fills up, data will continue to collect in the RX MIL FIFO. If the RX MIL FIFO fills up and overruns, subsequent RX frames will be lost until room is made in the RX data FIFO. For each frame of data that is lost, the RX Dropped Frames Counter (RX_DROP) is incremented.

RX and TX MIL FIFO levels are not visible to the host processor. RX and TX MIL FIFOs operate independent of the TX data and RX data and status FIFOs. FIFO levels set for the RX and TX data and Status FIFOs do not take into consideration the MIL FIFOs.

5.3.10 RX_DP_CTRL—Receive Datapath Control Register

Offset: 78h Size: 32 bits

This register is used to discard unwanted receive frames.

BITS	DESCRIPTION	TYPE	DEFAULT
31	RX Data FIFO Fast Forward (RX_FFWD): Writing a '1' to this bit causes the RX data FIFO to fast-forward to the start of the next frame. This bit will remain high until the RX data FIFO fast-forward operation has completed. No reads should be issued to the RX data FIFO while this bit is high. Note: Refer to section "Receive Data FIFO Fast Forward" on page 68 for detailed information regarding the use of RX_FFWD.	R/W SC	0b
30:0	Reserved	RO	-

5.3.11 RX_FIFO_INF—Receive FIFO Information Register

Offset: 7Ch Size: 32 bits

This register contains the used space in the receive FIFOs of the LAN89218 Ethernet Controller.

BITS	DESCRIPTION	TYPE	DEFAULT
31:24	Reserved	RO	-
23:16	RX Status FIFO Used Space (RXSUSED) . Indicates the amount of space in DWORDs, used in the RX Status FIFO.	RO	00h
15:0	RX Data FIFO Used Space (RXDUSED) . Reads the amount of space in bytes, used in the RX data FIFO. For each receive frame, this field is incremented by the length of the receive data rounded up to the nearest DWORD (if the payload does not end on a DWORD boundary).	RO	0000h

5.3.12 TX_FIFO_INF—Transmit FIFO Information Register

Offset: 80h Size: 32 bits

This register contains the free space in the transmit data FIFO and the used space in the transmit status FIFO in the LAN89218.

BITS	DESCRIPTION	TYPE	DEFAULT
31:24	Reserved	RO	-
23:16	TX Status FIFO Used Space (TXSUSED) . Indicates the amount of space in DWORDS used in the TX Status FIFO.	RO	00h
15:0	TX Data FIFO Free Space (TDFREE) . Reads the amount of space in bytes, available in the TX data FIFO. The application should never write more data than is available, as indicated by this value.	RO	1200h

5.3.13 PMT_CTRL— Power Management Control Register

Offset: 84h Size: 32 bits

This register controls the Power Management features. This register can be read while the LAN89218 is in a power saving mode.

Note: The LAN89218 must always be read at least once after power-up, reset, or upon return from a power-saving state or write operations will not function.

BITS	DESCRIPTION	TYPE	DEFAULT
31:14	Reserved	RO	-
13:12	<p>Power Management Mode (PM_MODE) – These bits set the LAN89218 into the appropriate Power Management mode. Special care must be taken when modifying these bits.</p> <p>Encoding:</p> <p>00b – D0 (normal operation) 01b – D1 (wake-up frame and magic packet detection are enabled) 10b – D2 (can perform energy detect) 11b – Reserved - Do not set in this mode</p> <p>Note: When the LAN89218 is in any of the reduced power modes, a write of any data to the BYTE_TEST register will wake-up the device. DO NOT PERFORM WRITES TO OTHER ADDRESSES while the READY bit in this register is cleared.</p>	SC	00b
11	Reserved	RO	-
10	PHY Reset (PHY_RST) – Writing a ‘1’ to this bit resets the PHY. The internal logic automatically holds the PHY reset for a minimum of 100 μ s. When the PHY is released from reset, this bit is automatically cleared. All writes to this bit are ignored while this bit is high.	SC	0b
9	Wake-On-Lan Enable (WOL_EN) – When set, the PME signal (if enabled with PME_EN) will be asserted in accordance with the PME_IND bit upon a WOL event. When set, the PME_INT will also be asserted upon a WOL event, regardless of the setting of the PME_EN bit.	R/W	0b
8	Energy-Detect Enable (ED_EN) - When set, the PME signal (if enabled with PME_EN) will be asserted in accordance with the PME_IND bit upon an Energy-Detect event. When set, the PME_INT will also be asserted upon an Energy Detect event, regardless of the setting of the PME_EN bit.	R/W	0b
7	Reserved	RO	-
6	PME Buffer Type (PME_TYPE) – When cleared, enables PME to function as an open-drain buffer for use in a Wired-Or configuration. When set, the PME output is a Push-Pull driver. When configured as an open-drain output the PME_POL field is ignored, and the output is always active low.	R/W NASR	0b
5:4	<p>WAKE-UP Status (WUPS) – This field indicates the cause of a wake-up event detection as follows</p> <p>00b – No wake-up event detected 01b – Energy detected 10b – Wake-up frame or magic packet detected 11b – Indicates multiple events occurred</p> <p>WUPS bits are cleared by writing a ‘1’ to the appropriate bit. The device must return to the D0 state (READY bit set) before these bits can be cleared.</p> <p>Note: In order to clear this bit, it is required that all event sources be cleared as well. The event sources are described in Figure 3.19 PME and PME_INT Signal Generation on page 51.</p>	R/WC	00

BITS	DESCRIPTION	TYPE	DEFAULT
3	<p>PME indication (PME_IND). The PME signal can be configured as a pulsed output or a static signal, which is asserted upon detection of a wake-up event.</p> <p>When set, the PME signal will pulse active for 50 ms upon detection of a wake-up event.</p> <p>When clear, the PME signal is driven continuously upon detection of a wake-up event.</p> <p>The PME signal can be deactivated by clearing the WUPS bits, or by clearing the appropriate enable (refer to Section 3.10.2.3, "Power Management Event Indicators," on page 51).</p>	R/W	0b
2	<p>PME Polarity (PME_POL). This bit controls the polarity of the PME signal. When set, the PME output is an active high signal. When reset, it is active low. When PME is configured as an open-drain output this field is ignored, and the output is always active low.</p>	R/W NASR	0b
1	<p>PME Enable (PME_EN). When set, this bit enables the external PME signal. This bit does not affect the PME interrupt (PME_INT).</p>	R/W	0b
0	<p>Device Ready (READY). When set, this bit indicates that LAN89218 is ready to be accessed. This register can be read when LAN89218 is in any power management mode. Upon waking from any power management mode, including power-up, the host processor can interrogate this field as an indication when LAN89218 has stabilized and is fully alive. Reads and writes of any other address are invalid until this bit is set.</p> <p>Note: With the exception of HW_CFG and PMT_CTRL, read access to any internal resources is forbidden while the READY bit is cleared.</p>	RO	-

5.3.14 GPIO_CFG—General Purpose IO Configuration Register

Offset: 88h Size: 32 bits

This register configures the GPIO and LED functions.

BITS	DESCRIPTION	TYPE	DEFAULT
31	Reserved	RO	-
30:28	LED[3:1] enable (LEDx_EN). A '1' sets the associated pin as an LED output. When cleared low, the pin functions as a GPIO signal. LED1/GPIO0 – bit 28 LED2/GPIO1 – bit 29 LED3/GPIO2 – bit 30	R/W	000
27	Reserved	RO	-
26:24	GPIO Interrupt Polarity 0-2 (GPIO_INT_POL). When set high, a high logic level on the corresponding GPIO pin will set the corresponding INT_STS register bit. When cleared low, a low logic level on the corresponding GPIO pin will set the corresponding INT_STS register bit. GPIO Interrupts must also be enabled in GPIOx_INT_EN in the INT_EN register. GPIO0 – bit 24 GPIO1 – bit 25 GPIO2 – bit 26 Note: GPIO inputs must be active for greater than 40 ns to be recognized as interrupt inputs.	R/W	000
23	Reserved	RO	-
22:20	EEPROM Enable (EEDIO_EN). The value of this field determines the function of the external EEDIO and EECLK: Refer to Table 5.4 for the EEPROM Enable bit function definitions. Note: The host must not change the function of the EEDIO and EECLK pins when an EEPROM read or write cycle is in progress. Do not use reserved settings.	R/W	000
19	Reserved	RO	-
18:16	GPIO Buffer Type 0-2 (GPIOBUFn). When set, the output buffer for the corresponding GPIO signal is configured as a push/pull driver. When cleared, the corresponding GPIO set configured as an open-drain driver. GPIO0 – bit 16 GPIO1 – bit 17 GPIO2 – bit 18	R/W	000
15:11	Reserved	RO	-
10:8	GPIO Direction 0-2 (GPDIRn). When set, enables the corresponding GPIO as output. When cleared the GPIO is enabled as an input. GPIO0 – bit 8 GPIO1 – bit 9 GPIO2 – bit 10	R/W	0000
7:5	Reserved	RO	-

BITS	DESCRIPTION	TYPE	DEFAULT
4:3	GPO Data 3-4 (GPODn). The value written is reflected on GPOn. GPO3 – bit 3 GPO4 – bit 4	R/W	00
2:0	GPIO Data 0-2 (GPIODn). When enabled as an output, the value written is reflected on GPIO n. When read, GPIO n reflects the current state of the corresponding GPIO pin. GPIO0 – bit 0 GPIO1 – bit 1 GPIO2 – bit 2	R/W	000

Table 5.4 EEPROM Enable Bit Definitions

[22]	[21]	[20]	EEDIO FUNCTION	EECLK FUNCTION
0	0	0	EEDIO	EECLK
0	0	1	GPO3	GPO4
0	1	0	Reserved	
0	1	1	GPO3	RX_DV
1	0	0	Reserved	
1	0	1	TX_EN	GPO4
1	1	0	TX_EN	RX_DV
1	1	1	TX_CLK	RX_CLK

5.3.15 GPT_CFG-General Purpose Timer Configuration Register

Offset: 8Ch Size: 32 bits

This register configures the General Purpose timer. The GP Timer can be configured to generate host interrupts at intervals defined in this register.

BITS	DESCRIPTION	TYPE	DEFAULT
31:30	Reserved	RO	-
29	GP Timer Enable (TIMER_EN) . When a one is written to this bit the GP Timer is put into the run state. When cleared, the GP Timer is halted. On the 1 to 0 transition of this bit the GPT_LOAD field will be preset to FFFFh.	R/W	0
28:16	Reserved	RO	-
15:0	General Purpose Timer Pre-Load (GPT_LOAD) . This value is pre-loaded into the GP-Timer.	R/W	FFFFh

5.3.16 GPT_CNT-General Purpose Timer Current Count Register

Offset: 90h Size: 32 bits

This register reflects the current value of the GP Timer.

BITS	DESCRIPTION	TYPE	DEFAULT
31:16	Reserved	RO	-
15:0	General Purpose Timer Current Count (GPT_CNT) . This 16-bit field reflects the current value of the GP Timer.	RO	FFFFh

5.3.17 WORD_SWAP—Word Swap Control

Offset: 98h Size: 32 bits

This register controls how words from the host data bus are mapped to the CSRs and Data FIFOs inside the LAN89218. The LAN89218 always sends data from the Transmit Data FIFO to the network so that the low order word is sent first, and always receives data from the network to the Receive Data FIFO so that the low order word is received first.

BITS	DESCRIPTION	TYPE	DEFAULT
31:0	<p>Word Swap. This field only has significance if the device is operated in 16-bit mode. In 32-bit mode, D[31:15] is always mapped to the high order word and D[15:0] is always mapped to the low order word. In 16-bit mode, if this field is set to 00000000h, or anything except 0xFFFFFFFFh, the LAN89218 maps words with address bit A[1]=1 to the high order words of the CSRs and Data FIFOs, and words with address bit A[1]=0 to the low order words of the CSRs and Data FIFOs. If this field is set to 0xFFFFFFFFh, the LAN89218 maps words with address bit A[1]=1 to the low order words of the CSRs and Data FIFOs, and words with address bit A[1]=0 to the high order words of the CSRs and Data FIFOs.</p> <p>Note: Refer to Section 3.7.1, "32-bit vs. 16-bit Host Bus Width Operation" for additional information.</p> <p>Note: Word swap is used in conjunction with the mixed endian functionality to determine the final byte ordering. Refer to Section 3.7.4, "Mixed Endian Support" for more information.</p>	R/W NASR	00000000h

5.3.18 FREE_RUN—Free-Run 25MHz Counter

Offset: 9Ch Size: 32 bits

This register reflects the value of the free-running 25 MHz counter.

BITS	DESCRIPTION	TYPE	DEFAULT
31:0	<p>Free Running SCLK Counter (FR_CNT):</p> <p>This field reflects the value of a free-running 32-bit counter. At reset the counter starts at zero and is incremented for every 25 MHz cycle. When the maximum count has been reached the counter will rollover. When read in 16-bit mode the count value is latched on the first read.</p> <p>Note: The FREE_RUN counter can take up to 160 ns to clear after a reset event.</p> <p>Note: This counter will run regardless of the power management states D0, D1 or D2.</p>	RO	-

5.3.19 RX_DROP– Receiver Dropped Frames Counter

Offset: A0h Size: 32 bits

This register indicates the number of receive frames that have been dropped.

BITS	DESCRIPTION	TYPE	DEFAULT
31:0	<p>RX Dropped Frame Counter (RX_DFC). This counter is incremented every time a receive frame is dropped. RX_DFC is cleared on any read of this register.</p> <p>An interrupt can be issued when this counter passes through its halfway point (7FFFFFFh to 80000000h).</p>	RC	00000000h

5.3.20 MAC_CSR_CMD – MAC CSR Synchronizer Command Register

Offset: A4h Size: 32 bits

This register is used to control the read and write operations with the MAC CSR's.

BITS	DESCRIPTION	TYPE	DEFAULT
31	<p>CSR Busy. When a 1 is written into this bit, the read or write operation is performed to the specified MAC CSR. This bit will remain set until the operation is complete. In the case of a read this means that the host can read valid data from the data register. The MAC_CSR_CMD and MAC_CSR_DATA registers should not be modified until this bit is cleared.</p>	SC	0
30	<p>R/nW. When set, this bit indicates that the host is requesting a read operation. When clear, the host is performing a write.</p>	R/W	0
29:8	<p>Reserved</p>	RO	-
7:0	<p>CSR Address. The 8-bit value in this field selects which MAC CSR will be accessed with the read or write operation.</p>	R/W	00h

5.3.21 MAC_CSR_DATA – MAC CSR Synchronizer Data Register

Offset: A8h Size: 32 bits

This register is used in conjunction with the MAC_CSR_CMD register to perform read and write operations with the MAC CSR's.

BITS	DESCRIPTION	TYPE	DEFAULT
31:0	MAC CSR Data. Value read from or written to the MAC CSR's.	R/W	00000000h

5.3.22 AFC_CFG – Automatic Flow Control Configuration Register

Offset: ACh Size: 32 bits

This register configures the mechanism that controls both the automatic, and software-initiated transmission of pause frames and back pressure.

Note: The LAN89218 will not transmit pause frames or assert back pressure if the transmitter is disabled.

BITS	DESCRIPTION	TYPE	DEFAULT
31:24	Reserved	RO	-
23:16	<p>Automatic Flow Control High Level (AFC_HI). Specifies, in multiples of 64 bytes, the level at which flow control will trigger. When this limit is reached the chip will apply back pressure or will transmit a pause frame as programmed in bits [3:0] of this register.</p> <p>During full-duplex operation only a single pause frame is transmitted when this level is reached. The pause time transmitted in this frame is programmed in the FCPT field of the FLOW register in the MAC CSR space.</p> <p>During half-duplex operation each incoming frame that matches the criteria in bits [3:0] of this register will be jammed for the period set in the BACK_DUR field.</p>	R/W	00h
15:8	<p>Automatic Flow Control Low Level (AFC_LO). Specifies, in multiples of 64 bytes, the level at which a pause frame is transmitted with a pause time setting of zero. When the amount of data in the RX data FIFO falls below this level the pause frame is transmitted. A pause time value of zero instructs the other transmitting device to immediately resume transmission. The zero time pause frame will only be transmitted if the RX data FIFO had reached the AFC_HI level and a pause frame was sent. A zero pause time frame is sent whenever automatic flow control is enabled in bits [3:0] of this register.</p> <p>Note: When automatic flow control is enabled the AFC_LO setting must always be less than the AFC_HI setting.</p>	R/W	00h
7:4	<p>Backpressure Duration (BACK_DUR). When the LAN89218 automatically asserts back pressure, it will be asserted for this period of time. This field has no function and is not used in full-duplex mode. Refer to Table 5.5, describing Backpressure Duration bit mapping for more information.</p>	R/W	0h
3	<p>Flow Control on Multicast Frame (FCMULT). When this bit is set, the LAN89218 will assert back pressure when the AFC level is reached and a multicast frame is received. This field has no function in full-duplex mode.</p>	R/W	0
2	<p>Flow Control on Broadcast Frame (FCBRD). When this bit is set, the LAN89218 will assert back pressure when the AFC level is reached and a broadcast frame is received. This field has no function in full-duplex mode.</p>	R/W	0
1	<p>Flow Control on Address Decode (FCADD). When this bit is set, the LAN89218 will assert back pressure when the AFC level is reached and a frame addressed to the LAN89218 is received. This field has no function in full-duplex mode.</p>	R/W	0

BITS	DESCRIPTION	TYPE	DEFAULT
0	<p>Flow Control on Any Frame (FCANY). When this bit is set, the LAN89218 will assert back pressure, or transmit a pause frame when the AFC level is reached and any frame is received. Setting this bit enables full-duplex flow control when the LAN89218 is operating in full-duplex mode.</p> <p>When this mode is enabled during half-duplex operation, the Flow Controller does not decode the MAC address and will send a pause frame upon receipt of a valid preamble (i.e., immediately at the beginning of the next frame after the RX data FIFO level is reached).</p> <p>When this mode is enabled during full-duplex operation, the Flow Controller will immediately instruct the MAC to send a pause frame when the RX data FIFO level is reached. The MAC will queue the pause frame transmission for the next available window.</p> <p>Setting this bit overrides bits [3:1] of this register.</p>	R/W	0

Table 5.5 Backpressure Duration Bit Mapping

[19:16]	BACKPRESSURE DURATION	
	100 Mbps Mode	10 Mbps Mode
0h	5 μ s	7.2 μ s
1h	10 μ s	12.2 μ s
2h	15 μ s	17.2 μ s
3h	25 μ s	27.2 μ s
4h	50 μ s	52.2 μ s
5h	100 μ s	102.2 μ s
6h	150 μ s	152.2 μ s
7h	200 μ s	202.2 μ s
8h	250 μ s	252.2 μ s
9h	300 μ s	302.2 μ s
Ah	350 μ s	352.2 μ s
Bh	400 μ s	402.2 μ s
Ch	450 μ s	452.2 μ s
Dh	500 μ s	502.2 μ s
Eh	550 μ s	552.2 μ s
Fh	600 μ s	602.2 μ s

5.3.23 E2P_CMD – EEPROM Command Register

Offset: B0h Size: 32 bits

This register is used to control the read and write operations with the Serial EEPROM.

BITS	DESCRIPTION	TYPE	DEFAULT
31	<p>EPC Busy: When a 1 is written into this bit, the operation specified in the EPC command field is performed at the specified EEPROM address. This bit will remain set until the operation is complete. In the case of a read this means that the host can read valid data from the E2P data register. The E2P_CMD and E2P_DATA registers should not be modified until this bit is cleared. In the case where a write is attempted and an EEPROM is not present, the EPC Busy remains busy until the EPC Time-out occurs. At that time the busy bit is cleared.</p> <p>Note: EPC busy will be high immediately following power-up or reset. After the EEPROM controller has finished reading (or attempting to read) the MAC address from the EEPROM the EPC Busy bit is cleared.</p>	SC	0

BITS	DESCRIPTION	TYPE	DEFAULT																																				
30:28	<p>EPC command. This field is used to issue commands to the EEPROM controller. The EPC will execute commands when the EPC Busy bit is set. A new command must not be issued until the previous command completes. This field is encoded as follows:</p> <table border="1" data-bbox="379 618 1058 1050"> <thead> <tr> <th>[30]</th> <th>[29]</th> <th>[28]</th> <th>OPERATION</th> </tr> </thead> <tbody> <tr> <td>0</td> <td>0</td> <td>0</td> <td>READ</td> </tr> <tr> <td>0</td> <td>0</td> <td>1</td> <td>EWDS</td> </tr> <tr> <td>0</td> <td>1</td> <td>0</td> <td>EWEN</td> </tr> <tr> <td>0</td> <td>1</td> <td>1</td> <td>WRITE</td> </tr> <tr> <td>1</td> <td>0</td> <td>0</td> <td>WRAL</td> </tr> <tr> <td>1</td> <td>0</td> <td>1</td> <td>ERASE</td> </tr> <tr> <td>1</td> <td>1</td> <td>0</td> <td>ERAL</td> </tr> <tr> <td>1</td> <td>1</td> <td>1</td> <td>Reload</td> </tr> </tbody> </table> <p>READ (Read Location): This command will cause a read of the EEPROM location pointed to by EPC Address. The result of the read is available in the E2P_DATA register.</p> <p>EWDS (Erase/Write Disable): After issued, the EEPROM will ignore erase and write commands. To re-enable erase/write operations issue the EWEN command.</p> <p>EWEN (Erase/Write Enable): Enables the EEPROM for erase and write operations. The EEPROM will allow erase and write operations until the Erase/Write Disable command is sent, or until power is cycled.</p> <p>Note: The EEPROM device will power-up in the erase/write-disabled state. Any erase or write operations will fail until an Erase/Write Enable command is issued.</p> <p>WRITE (Write Location): If erase/write operations are enabled in the EEPROM, this command will cause the contents of the E2P_DATA register to be written to the EEPROM location selected by the EPC Address field.</p> <p>WRAL (Write All): If erase/write operations are enabled in the EEPROM, this command will cause the contents of the E2P_DATA register to be written to every EEPROM memory location.</p> <p>ERASE (Erase Location): If erase/write operations are enabled in the EEPROM, this command will erase the location selected by the EPC Address field.</p> <p>ERAL (Erase All): If erase/write operations are enabled in the EEPROM, this command will initiate a bulk erase of the entire EEPROM.</p> <p>RELOAD (MAC Address Reload): Instructs the EEPROM controller to reload the MAC address from the EEPROM. If a value of 0xA5 is not found in the first address of the EEPROM, the EEPROM is assumed to be un-programmed and MAC Address Reload operation will fail. The "MAC Address Loaded" bit indicates a successful load of the MAC address.</p>	[30]	[29]	[28]	OPERATION	0	0	0	READ	0	0	1	EWDS	0	1	0	EWEN	0	1	1	WRITE	1	0	0	WRAL	1	0	1	ERASE	1	1	0	ERAL	1	1	1	Reload	R/W	0
[30]	[29]	[28]	OPERATION																																				
0	0	0	READ																																				
0	0	1	EWDS																																				
0	1	0	EWEN																																				
0	1	1	WRITE																																				
1	0	0	WRAL																																				
1	0	1	ERASE																																				
1	1	0	ERAL																																				
1	1	1	Reload																																				
27:10	Reserved	RO	-																																				

BITS	DESCRIPTION	TYPE	DEFAULT
9	<p>EPC Time-out. If an EEPROM operation is performed, and there is no response from the EEPROM within 30 ms, the EEPROM controller will time-out and return to its idle state. This bit is set when a time-out occurs indicating that the last operation was unsuccessful.</p> <p>Note: If the EEDIO signal pin is externally pulled-high, EPC commands will not time out if the EEPROM device is missing. In this case the EPC Busy bit will be cleared as soon as the command sequence is complete. It should also be noted that the ERASE, ERAL, WRITE and WRAL commands are the only EPC commands that will time-out if an EEPROM device is not present <i>-and-</i> the EEDIO signal is pulled low</p>	R/WC	0
8	<p>MAC Address Loaded. When set, this bit indicates that a valid EEPROM was found, and that the MAC address programming has completed normally. This bit is set after a successful load of the MAC address after power-up, or after a RELOAD command has completed</p>	R/WC	-
7:0	<p>EPC Address. The 8-bit value in this field is used by the EEPROM Controller to address the specific memory location in the Serial EEPROM. This is a Byte aligned address.</p>	R/W	00h

5.3.24 E2P_DATA – EEPROM Data Register

Offset: B4h Size: 32 bits

This register is used in conjunction with the E2P_CMD register to perform read and write operations with the Serial EEPROM.

BITS	DESCRIPTION	TYPE	DEFAULT
31:8	Reserved	RO	-
7:0	EEPROM Data. Value read from or written to the EEPROM.	R/W	00h

5.4 MAC Control and Status Registers

These registers are located in the MAC module and are accessed indirectly through the MAC-CSR synchronizer port. Table 5.6, "MAC CSR Register Map", shown below, lists the MAC registers that are accessible through the indexing method using the MAC_CSR_CMD and MAC_CSR_DATA registers (see sections MAC_CSR_CMD – MAC CSR Synchronizer Command Register and MAC_CSR_DATA – MAC CSR Synchronizer Data Register).

Table 5.6 MAC CSR Register Map

MAC CONTROL AND STATUS REGISTERS			
INDEX	SYMBOL	REGISTER NAME	DEFAULT
1	MAC_CR	MAC Control Register	00040000h
2	ADDRH	MAC Address High	0000FFFFh
3	ADDRL	MAC Address Low	FFFFFFFFh
4	HASHH	Multicast Hash Table High	00000000h
5	HASHL	Multicast Hash Table Low	00000000h
6	MII_ACC	MII Access	00000000h
7	MII_DATA	MII Data	00000000h
8	FLOW	Flow Control	00000000h
9	VLAN1	VLAN1 Tag	00000000h
A	VLAN2	VLAN2 Tag	00000000h
B	WUFF	Wake-up Frame Filter	00000000h
C	WUCSR	Wake-up Control and Status	00000000h
D	COE_CR	Checksum Offload Engine Control	00000000h

5.4.1 MAC_CR—MAC Control Register

Offset:	1	Attribute:	R/W
Default Value:	00040000h	Size:	32 bits

This register establishes the RX and TX operation modes and controls for address filtering and packet filtering.

BITS	DESCRIPTION
31	Receive All Mode (RXALL). When set, all incoming packets will be received and passed on to the address filtering Function for processing of the selected filtering mode on the received frame. Address filtering then occurs and is reported in Receive Status. When reset, only frames that pass Destination Address filtering will be sent to the Application.
30:24	Reserved
23	Disable Receive Own (RCVOWN). When set, the MAC disables the reception of frames when the MII TX_EN signal is asserted. The MAC blocks the transmitted frame on the receive path. When reset, the MAC receives all packets the PHY gives, including those transmitted by the MAC. This bit should be reset when the Full Duplex Mode bit is set.
22	Reserved
21	Loopback operation Mode (LOOPBK). Selects the loop back operation modes for the MAC. This is only for full duplex mode 1'b0: Normal: No feedback 1'b1: Internal: Through MII In internal loopback mode, the TX frame is received by the Internal MII interface, and sent back to the MAC without being sent to the PHY. Note: When enabling or disabling the loopback mode it can take up to 10μs for the mode change to occur. The transmitter and receiver must be stopped and disabled when modifying the LOOPBK bit. The transmitter or receiver should not be enabled within 10μs of modifying the LOOPBK bit.
20	Full Duplex Mode (FDPX). When set, the MAC operates in Full-Duplex mode, in which it can transmit and receive simultaneously. In Full-Duplex mode, the heartbeat check is disabled and the heartbeat fail status should thus be ignored.
19	Pass All Multicast (MCPAS). When set, indicates that all incoming frames with a Multicast destination address (first bit in the destination address field is 1) are received. Incoming frames with physical address (Individual Address/Unicast) destinations are filtered and received only if the address matches the MAC Address.
18	Promiscuous Mode (PRMS). When set, indicates that any incoming frame is received regardless of its destination address.
17	Inverse filtering (INVFILT). When set, the address check Function operates in Inverse filtering mode. This is valid only during Perfect filtering mode.
16	Pass Bad Frames (PASSBAD). When set, all incoming frames that passed address filtering are received, including runt frames and collided frames.
15	Hash Only Filtering mode (HO). When set, the address check Function operates in the Imperfect Address Filtering mode both for physical and multicast addresses
14	Reserved

BITS	DESCRIPTION
13	<p>Hash/Perfect Filtering Mode (HPFILT). When reset (0), the LAN89218 will implement a perfect address filter on incoming frames according the address specified in the MAC address register.</p> <p>When set (1), the address check Function does imperfect address filtering of multicast incoming frames according to the hash table specified in the multicast hash table register.</p> <p>If the Hash Only Filtering mode (HO) bit is set (1), then the physical (IA) are imperfect filtered too. If the Hash Only Filtering mode (HO) bit is reset (0), then the IA addresses are perfect address filtered according to the MAC Address register</p>
12	<p>Late Collision Control (LCOLL). When set, enables retransmission of the collided frame even after the collision period (late collision). When reset, the MAC disables frame transmission on a late collision. In any case, the Late Collision status is appropriately updated in the Transmit Packet status.</p>
11	<p>Disable Broadcast Frames (BCAST). When set, disables the reception of broadcast frames. When reset, forwards all broadcast frames to the application.</p> <p>Note: When wake-up frame detection is enabled via the WUEN bit of the WUCSR—Wake-up Control and Status Register, a broadcast wake-up frame will wake-up the device despite the state of this bit.</p>
10	<p>Disable Retry (DISRTY). When set, the MAC attempts only one transmission. When a collision is seen on the bus, the MAC ignores the current frame and goes to the next frame and a retry error is reported in the Transmit status. When reset, the MAC attempts 16 transmissions before signaling a retry error.</p>
9	<p>Reserved</p>
8	<p>Automatic Pad Stripping (PADSTR). When set, the MAC strips the pad field on all incoming frames, if the length field is less than 46 bytes. The FCS field is also stripped, since it is computed at the transmitting station based on the data and pad field characters, and is invalid for a received frame that has had the pad characters stripped. Receive frames with a 46-byte or greater length field are passed to the Application unmodified (FCS is not stripped). When reset, the MAC passes all incoming frames to the host unmodified.</p> <p>Note: When PADSTR is enabled, the RX Checksum Offload Engine must be disabled (bit 0 (RXCOE_EN) of the COE_CR—Checksum Offload Engine Control Register) and vice versa. These functions cannot be enabled simultaneously.</p>

BITS	DESCRIPTION										
7:6	<p>BackOff Limit (BOLMT). The BOLMT bits allow the user to set its back-off limit in a relaxed or aggressive mode. According to IEEE 802.3, the MAC has to wait for a random number [r] of slot-times** after it detects a collision, where: (eq.1) $0 < r < 2^K$ The exponent K is dependent on how many times the current frame to be transmitted has been retried, as follows: (eq.2) $K = \min(n, 10)$ where n is the current number of retries. If a frame has been retried three times, then K = 3 and r = 8 slot-times maximum. If it has been retried 12 times, then K = 10, and r = 1024 slot-times maximum. An LFSR (linear feedback shift register) 20-bit counter emulates a 20bit random number generator, from which r is obtained. Once a collision is detected, the number of the current retry of the current frame is used to obtain K (eq.2). This value of K translates into the number of bits to use from the LFSR counter. If the value of K is 3, the MAC takes the value in the first three bits of the LFSR counter and uses it to count down to zero on every slot-time. This effectively causes the MAC to wait eight slot-times. To give the user more flexibility, the BOLMT value forces the number of bits to be used from the LFSR counter to a predetermined value as in the table below.</p> <table border="1" data-bbox="525 882 1238 1122"> <thead> <tr> <th>BOLMT Value</th> <th># Bits Used from LFSR Counter</th> </tr> </thead> <tbody> <tr> <td>2'b00</td> <td>10</td> </tr> <tr> <td>2'b01</td> <td>8</td> </tr> <tr> <td>2'b10</td> <td>4</td> </tr> <tr> <td>2'b11</td> <td>1</td> </tr> </tbody> </table> <p>Thus, if the value of K = 10, the MAC will look at the BOLMT if it is 00, then use the lower ten bits of the LFSR counter for the wait countdown. If the BOLMT is 10, then it will only use the value in the first four bits for the wait countdown, etc. **Slot-time = 512 bit times. (See IEEE 802.3 Spec., Secs. 4.2.3.25 and 4.4.2.1)</p>	BOLMT Value	# Bits Used from LFSR Counter	2'b00	10	2'b01	8	2'b10	4	2'b11	1
BOLMT Value	# Bits Used from LFSR Counter										
2'b00	10										
2'b01	8										
2'b10	4										
2'b11	1										
5	<p>Deferral Check (DFCHK). When set, enables the deferral check in the MAC. The MAC will abort the transmission attempt if it has deferred for more than 24,288 bit times. Deferral starts when the transmitter is ready to transmit, but is prevented from doing so because the CRS is active. Deferral time is not cumulative. If the transmitter defers for 10,000 bit times, then transmits, collides, backs off, and then has to defer again after completion of back-off, the deferral timer resets to 0 and restarts. When reset, the deferral check is disabled in the MAC and the MAC defers indefinitely.</p>										
4	Reserved										
3	<p>Transmitter enable (TXEN). When set, the MAC's transmitter is enabled and it will transmit frames from the buffer onto the cable. When reset, the MAC's transmitter is disabled and will not transmit any frames.</p>										
2	<p>Receiver Enable (RXEN). When set (1), the MAC's receiver is enabled and will receive frames from the internal PHY. When reset, the MAC's receiver is disabled and will not receive any frames from the internal PHY.</p>										
1:0	Reserved										

5.4.2 ADDRH—MAC Address High Register

Offset:	2	Attribute:	R/W
Default Value:	0000FFFFh	Size:	32 bits

The MAC Address High register contains the upper 16-bits of the physical address of the MAC. The contents of this register are optionally loaded from the EEPROM at power-on through the EEPROM Controller if a programmed EEPROM is detected. The least significant byte of this register (bits [7:0]) is loaded from address 0x05 of the EEPROM. The second byte (bits [15:8]) is loaded from address 0x06 of the EEPROM. Refer to [Section 4.6](#) for more information on the EEPROM. [Section 5.4.3](#) details the byte ordering of the ADDRL and ADDRH registers with respect to the reception of the Ethernet physical address.

BITS	DESCRIPTION
31:16	Reserved
15:0	Physical Address [47:32] . This field contains the upper 16-bits (47:32) of the Physical Address of the LAN89218 device. The content of this field is undefined until loaded from the EEPROM at power-on. The host can update the contents of this field after the initialization process has completed.

5.4.3 ADDRL—MAC Address Low Register

Offset:	3	Attribute:	R/W
Default Value:	FFFFFFFFh	Size:	32 bits

The MAC Address Low register contains the lower 32 bits of the physical address of the MAC. The contents of this register are optionally loaded from the EEPROM at power-on through the EEPROM Controller if a programmed EEPROM is detected. The least significant byte of this register (bits [7:0]) is loaded from address 0x01 of the EEPROM. The most significant byte of this register is loaded from address 0x04 of the EEPROM. Refer to [Section 4.6](#) for more information on the EEPROM.

BITS	DESCRIPTION
31:0	Physical Address [31:0]. This field contains the lower 32 bits (31:0) of the Physical Address of the LAN89218 device. The content of this field is undefined until loaded from the EEPROM at power-on. The host can update the contents of this field after the initialization process has completed.

[Table 5.7](#) below illustrates the byte ordering of the ADDRL and ADDRH registers with respect to the reception of the Ethernet physical address. Also shown is the correlation between the EEPROM addresses and ADDRL and ADDRH registers.

Table 5.7 ADDRL, ADDRH and EEPROM Byte Ordering

EEPROM ADDRESS	ADDRN	ORDER OF RECEPTION ON ETHERNET
0x01	ADDRL[7:0]	1 st
0x02	ADDRL[15:8]	2 nd
0x03	ADDRL[23:16]	3 rd
0x04	ADDRL[31:24]	4 th
0x05	ADDRH[7:0]	5 th
0x06	ADDRH[15:8]	6 th

As an example, if the desired Ethernet physical address is 12-34-56-78-9A-BC, the ADDRL and ADDRH registers would be programmed as shown in [Figure 5.2](#). The values required to automatically load this configuration from the EEPROM are also shown.

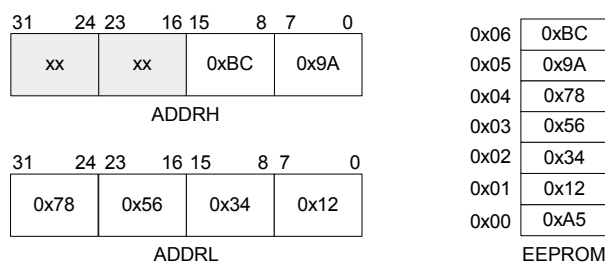

Figure 5.2 Example ADDRL, ADDRH and EEPROM Setup

Note: By convention, the left most byte of the Ethernet address (in this example 0x12) is the most significant byte and is transmitted/received first.

5.4.4 HASHH—Multicast Hash Table High Register

Offset:	4	Attribute:	R/W
Default Value:	00000000h	Size:	32 bits

The 64-bit Multicast table is used for group address filtering. For hash filtering, the contents of the destination address in the incoming frame is used to index the contents of the Hash table. The most significant bit determines the register to be used (Hi/Low), while the other five bits determine the bit within the register. A value of 00000 selects Bit 0 of the Multicast Hash Table Lo register and a value of 11111 selects the Bit 31 of the Multicast Hash Table Hi register.

If the corresponding bit is 1, then the multicast frame is accepted. Otherwise, it is rejected. If the “Pass All Multicast” (MCPAS) bit is set (1), then all multicast frames are accepted regardless of the multicast hash values.

The Multicast Hash Table Hi register contains the higher 32 bits of the hash table and the Multicast Hash Table Low register contains the lower 32 bits of the hash table.

BITS	DESCRIPTION
31:0	Upper 32 bits of the 64-bit Hash Table

5.4.5 HASHL—Multicast Hash Table Low Register

Offset:	5	Attribute:	R/W
Default Value:	00000000h	Size:	32 bits

This register defines the lower 32-bits of the Multicast Hash Table. Refer to [Table 5.4.4, "HASHH—Multicast Hash Table High Register"](#) for further details.

BITS	DESCRIPTION
31:0	Lower 32 bits of the 64-bit Hash Table

5.4.6 MII_ACC—MII Access Register

Offset:	6	Attribute:	R/W
Default Value:	00000000h	Size:	32 bits

This register is used to control the Management cycles to the PHY.

BITS	DESCRIPTION
31:16	Reserved
15:11	PHY Address: For every access to this register, this field must be set to 00001b.
10:6	MII Register Index (MIIRINDA): These bits select the desired MII register in the PHY.
5:2	Reserved
1	MII Write (MIIWnR): Setting this bit tells the PHY that this will be a write operation using the MII data register. If this bit is not set, this will be a read operation, packing the data in the MII data register.
0	MII Busy (MIIBZY): This bit must be polled to determine when the MII register access is complete. This bit must read a logical 0 before writing to this register and MII data register. The LAN driver software must set (1) this bit in order for the LAN89218 to read or write any of the MII PHY registers. During a MII register access, this bit will be set, signifying a read or write access is in progress. The MII data register must be kept valid until the MAC clears this bit during a PHY write operation. The MII data register is invalid until the MAC has cleared this bit during a PHY read operation.

5.4.7 MII_DATA—MII Data Register

Offset:	7	Attribute:	R/W
Default Value:	00000000h	Size:	32 bits

This register contains either the data to be written to the PHY register specified in the MII Access Register, or the read data from the PHY register whose index is specified in the MII Access Register.

BITS	DESCRIPTION
31:16	Reserved
15:0	MII Data. This contains the 16-bit value read from the PHY read operation or the 16-bit data value to be written to the PHY before an MII write operation.

5.4.8 FLOW—Flow Control Register

Offset:	8	Attribute:	R/W
Default Value:	00000000h	Size:	32 bits

This register controls the generation and reception of the Control (Pause command) frames by the MAC's flow control block. The control frame fields are selected as specified in the 802.3x Specification and the Pause-Time value from this register is used in the "Pause Time" field of the control frame. In full-duplex mode the FCBSY bit is set until the control frame is transferred onto the cable. In half-duplex mode FCBSY is set while back pressure is being asserted. The host has to make sure that the Busy bit is cleared before writing the register. The Pass Control Frame bit (FCPASS) does not affect the sending of the frames, including Control Frames, to the Application Interface. The Flow Control Enable (FCEN) bit enables the receive portion of the Flow Control block.

This register is used in conjunction with the AFC_CFG register in the Slave CSRs to configure flow control. Software flow control is initiated using the AFC_CFG register.

Note: The LAN89218 will not transmit pause frames or assert back pressure if the transmitter is disabled.

BITS	DESCRIPTION
31:16	Pause Time (FCPT). This field indicates the value to be used in the PAUSE TIME field in the control frame. This field must be initialized before full-duplex automatic flow control is enabled.
15:3	Reserved
2	Pass Control Frames (FCPASS). When set, the MAC sets the Packet Filter bit in the Receive packet status to indicate to the Application that a valid Pause frame has been received. The Application must accept or discard a received frame based on the Packet Filter control bit. The MAC receives, decodes and performs the Pause function when a valid Pause frame is received in Full-Duplex mode and when flow control is enabled (FCE bit set). When reset, the MAC resets the Packet Filter bit in the Receive packet status. The MAC always passes the data of all frames it receives (including Flow Control frames) to the Application. Frames that do not pass Address filtering, as well as frames with errors, are passed to the Application. The Application must discard or retain the received frame's data based on the received frame's STATUS field. Filtering modes (Promiscuous mode, for example) take precedence over the FCPASS bit.
1	Flow Control Enable (FCEN). When set, enables the MAC Flow Control function. The MAC decodes all incoming frames for control frames; if it receives a valid control frame (PAUSE command), it disables the transmitter for a specified time (Decoded pause time x slot time). When reset, the MAC flow control function is disabled; the MAC does not decode frames for control frames. Note: Flow Control is applicable when the MAC is set in Full Duplex Mode. In Half-Duplex mode, this bit enables the Backpressure function to control the flow of received frames to the MAC.
0	Flow Control Busy (FCBSY). This bit is set high whenever a pause frame or back pressure is being transmitted. This bit should read logical 0 before writing to the Flow Control (FLOW) register. During a transfer of Control Frame, this bit continues to be set, signifying that a frame transmission is in progress. After the PAUSE control frame's transmission is complete, the MAC resets to 0. Notes: <ul style="list-style-type: none"> ■ When writing this register the FCBSY bit must always be zero. ■ Applications must always write a zero to this bit

5.4.9 VLAN1—VLAN1 Tag Register

Offset:	9	Attribute:	R/W
Default Value:	00000000h	Size:	32 bits

This register contains the VLAN tag field to identify VLAN1 frames. For VLAN frames the legal frame length is increased from 1518 bytes to 1522 bytes.

BITS	DESCRIPTION
31:16	Reserved
15:0	VLAN1 Tag Identifier (VTI1). This contains the VLAN Tag field to identify the VLAN1 frames. This field is compared with the 13th and 14th bytes of the incoming frames for VLAN1 frame detection. If used, this register must be set to 0x8100.

5.4.10 VLAN2—VLAN2 Tag Register

Offset:	A	Attribute:	R/W
Default Value:	00000000h	Size:	32 bits

This register contains the VLAN tag field to identify VLAN2 frames. For VLAN frames the legal frame length is increased from 1518 bytes to 1522 bytes.

BITS	DESCRIPTION
31:16	Reserved
15:0	VLAN2 Tag Identifier (VTI2). This contains the VLAN Tag field to identify the VLAN2 frames. This field is compared with the 13th and 14th bytes of the incoming frames for VLAN2 frame detection. If used, this register must be set to 0x8100.

5.4.11 WUFF—Wakeup Frame Filter

Offset:	B	Attribute:	R/W
Default Value:	00000000h	Size:	32 bits

This register is used to configure the wake up frame filter.

BITS	DESCRIPTION
31:0	<p>Wakeup Frame Filter (WFF). The Wakeup Frame Filter is configured through this register using an indexing mechanism. Following a reset, the MAC loads the first value written to this location to the first DWORD in the Wakeup Frame Filter (filter 0 byte mask). The second value written to this location is loaded to the second DWORD in the Wakeup Frame Filter (filter 1 byte mask) and so on. Once all eight DWORDs have been written, the internal pointer will once again point to the first entry and the filter entries can be modified in the same manner. Similarly, eight DWORDs can be read sequentially to obtain the values stored in the WFF.</p> <p>Note: This register should be read and written using eight consecutive DWORD operations. Failure to read or write the entire contents of the WFF may cause the internal read/write pointers to be left in a position other than pointing to the first entry. A mechanism for resetting the internal pointers to the beginning of the WFF is available via the WFF Pointer Reset (WFF_PTR_RST) bit of the WUCSR—Wake-up Control and Status Register. This mechanism enables the application program to re-synchronize with the internal WFF pointers if it has not previously read/written the complete contents of the WFF.</p>

5.4.12 WUCSR—Wake-up Control and Status Register

Offset:	C	Attribute:	R/W
Default Value:	00000000h	Size:	32 bits

This register contains data pertaining to the MAC's remote wake-up status and capabilities.

BITS	DESCRIPTION
31	WFF Pointer Reset (WFF_PTR_RST) . This self-clearing bit resets the Wake-up Frame Filter (WFF) internal read and write pointers to the beginning of the WFF.
30:10	Reserved
9	Global Unicast Enable (GUE) . When set, the MAC wakes up from power-saving mode on receipt of a global unicast frame. A global unicast frame has the MAC Address [0] bit set to 0.
8:7	Reserved
6	Remote Wake-Up Frame Received (WUFR) . The MAC, upon receiving a valid Remote Wake-up frame, sets this bit.
5	Magic Packet Received (MPR) . The MAC, upon receiving a valid Magic Packet, sets this bit.
4:3	Reserved
2	Wake-Up Frame enabled (WUEN) . When set, Remote Wake-Up mode is enabled and the MAC is capable of detecting wake-up frames as programmed in the wake-up frame filter.
1	Magic Packet Enable (MPEN) . When set, Magic Packet Wake-up mode is enabled.
0	Reserved

5.4.13 COE_CR—Checksum Offload Engine Control Register

Offset:	D	Attribute:	R/W
Default Value:	00000000h	Size:	32 bits

This register controls the transmit and receive checksum offload engines.

BITS	DESCRIPTION
31:17	Reserved
16	<p>TX Checksum Offload Engine Enable (TXCOE_EN). This bit enables/disables the Transmit COE. This bit may only be changed if the TX data path is disabled.</p> <p>0: The TXCOE is bypassed 1: The TXCOE is enabled</p>
15:2	Reserved
1	<p>RX Checksum Offload Engine Mode (RXCOE_MODE). This register indicates whether the RXCOE will check for VLAN tags or a SNAP header prior to beginning its checksum calculation. In its default mode, the calculation will always begin 14 bytes into the frame.</p> <p>The RXCOE_MODE may only be changed if the RX data path is disabled.</p> <p>0: Begin checksum calculation after first 14 bytes of Ethernet Frame 1: Begin checksum calculation at start of L3 packet by adjusting for VLAN tags and/or SNAP header.</p>
0	<p>RX Checksum Offload Engine Enable (RXCOE_EN). This bit enables/disables the Receive COE. This bit may only be changed if the RX data path is disabled.</p> <p>0: The RXCOE is bypassed 1: The RXCOE is enabled</p> <p>Note: When the RXCOE is enabled, automatic pad stripping must be disabled (bit 8 (PADSTR) of the MAC_CR—MAC Control Register) and vice versa. These functions cannot be enabled simultaneously.</p>

5.5 PHY Registers

The PHY registers are not memory mapped. These registers are accessed indirectly through the MAC via the MII_ACC and MII_DATA registers. An index must be used to access individual PHY registers. PHY Register Indexes are shown in [Table 5.8, "LAN89218 PHY Control and Status Register"](#).

Note: The NASR (Not Affected by Software Reset) designation is only applicable when bit 15 of the PHY Basic Control Register (Reset) is set.

Table 5.8 LAN89218 PHY Control and Status Register

PHY CONTROL AND STATUS REGISTERS	
INDEX (IN DECIMAL)	REGISTER NAME
0	Basic Control Register
1	Basic Status Register
2	PHY Identifier 1
3	PHY Identifier 2
4	Auto-Negotiation Advertisement Register
5	Auto-Negotiation Link Partner Ability Register
6	Auto-Negotiation Expansion Register
17	Mode Control/Status Register
18	Special Modes Register
27	Special Control/Status Indications
29	Interrupt Source Register
30	Interrupt Mask Register
31	PHY Special Control/Status Register

5.5.1 Basic Control Register

Index (In Decimal): 0 Size: 16-bits

BITS	DESCRIPTION	TYPE	DEFAULT
15	Reset. 1 = software reset. Bit is self-clearing. For best results, when setting this bit do not set other bits in this register.	RW/SC	0
14	Loopback. 1 = loopback mode, 0 = normal operation	RW	0
13	Speed Select. 1 = 100 Mbps, 0 = 10 Mbps. Ignored if Auto Negotiation is enabled (0.12 = 1).	RW	See Note 5.2
12	Auto-Negotiation Enable. 1 = enable auto-negotiate process (overrides 0.13 and 0.8), 0 = disable auto-negotiate process.	RW	See Note 5.2
11	Power Down. 1 = General power down-mode, 0 = normal operation. Note: After this bit is cleared, the PHY may auto-negotiate with it's partner station. This process may take a few seconds to complete. Once auto-negotiation is complete, bit 5 of the PHY's Basic Status Register will be set.	RW	0
10	Reserved	RO	0
9	Restart Auto-Negotiate. 1 = restart auto-negotiate process, 0 = normal operation. Bit is self-clearing.	RW/SC	0
8	Duplex Mode. 1 = full duplex, 0 = half duplex. Ignored if Auto Negotiation is enabled (0.12 = 1).	RW	0
7	Collision Test. 1 = enable COL test, 0 = disable COL test	RW	0
6:0	Reserved	RO	0

Note 5.2 The default value of this bit is determined by Pin 74 "SPEED_SEL". Refer to the pin description section for more details.

5.5.2 Basic Status Register

Index (In Decimal): 1 Size: 16-bits

BITS	DESCRIPTION	TYPE	DEFAULT
15	100Base-T4. 1 = T4 able, 0 = no T4 ability	RO	0
14	100Base-TX Full Duplex. 1 = TX with full duplex, 0 = no TX full duplex ability.	RO	1
13	100Base-TX Half Duplex. 1 = TX with half duplex, 0 = no TX half duplex ability.	RO	1
12	10Base-T Full Duplex. 1 = 10Mbps with full duplex, 0 = no 10Mbps with full duplex ability	RO	1
11	10Base-T Half Duplex. 1 = 10Mbps with half duplex, 0 = no 10Mbps with half duplex ability	RO	1
10:6	Reserved	RO	0
5	Auto-Negotiate Complete. 1 = auto-negotiate process completed, 0 = auto-negotiate process not completed	RO	0
4	Remote Fault. 1 = remote fault condition detected, 0 = no remote fault	RO/LH	0
3	Auto-Negotiate Ability. 1 = able to perform auto-negotiation function, 0 = unable to perform auto-negotiation function	RO	1
2	Link Status. 1 = link is up, 0 = link is down	RO/LL	0
1	Jabber Detect. 1 = jabber condition detected, 0 = no jabber condition detected	RO/LH	0
0	Extended Capabilities. 1 = supports extended capabilities registers, 0 = does not support extended capabilities registers.	RO	1

5.5.3 PHY Identifier 1

Index (In Decimal): 2 Size: 16-bits

BITS	DESCRIPTION	TYPE	DEFAULT
15:0	PHY ID Number. Assigned to the 3rd through 18th bits of the Organizationally Unique Identifier (OUI), respectively.	RO	0x0007h

5.5.4 PHY Identifier 2

Index (In Decimal): 3 Size: 16-bits

BITS	DESCRIPTION	TYPE	DEFAULT
15:10	PHY ID Number b. Assigned to the 19th through 24th bits of the OUI.	RO	0xC0C3h
9:4	Model Number. Six-bit manufacturer's model number.	RO	
3:0	Revision Number. Four-bit manufacturer's revision number.	RO	

5.5.5 Auto-negotiation Advertisement

Index (In Decimal): 4 Size: 16-bits

BITS	DESCRIPTION	TYPE	DEFAULT
15:14	Reserved	RO	00
13	Remote Fault. 1 = remote fault detected, 0 = no remote fault	R/W	0
12	Reserved	R/W	0
11:10	Pause Operation. (See Note 5.3) 00 No PAUSE 01 Symmetric PAUSE 10 Asymmetric PAUSE 11 Advertise support for both Symmetric PAUSE and Asymmetric PAUSE	R/W	00
9	Reserved	RO	0
8	100Base-TX Full Duplex. 1 = TX with full duplex, 0 = no TX full duplex ability	R/W	See Note 5.4
7	100Base-TX. 1 = TX able, 0 = no TX ability	R/W	1
6	10Base-T Full Duplex. 1 = 10 Mbps with full duplex, 0 = no 10 Mbps with full duplex ability	R/W	See Note 5.4
5	10Base-T. 1 = 10 Mbps able, 0 = no 10 Mbps ability	R/W	See Note 5.4
4:0	Selector Field. [00001] = IEEE 802.3	R/W	00001

Note 5.3 When both symmetric PAUSE and asymmetric PAUSE support are advertised (value of 11), the device will only be configured to, at most, one of the two settings upon auto-negotiation completion.

Note 5.4 This default value of this bit is determined by Pin 74 "SPEED_SEL". Refer to the pin description section for more details.

5.5.6 Auto-negotiation Link Partner Ability

Index (In Decimal): 5 Size: 16-bits

BITS	DESCRIPTION	TYPE	DEFAULT
15	Next Page. 1 = next page capable, 0 = no next page ability. This device does not support next page ability.	RO	0
14	Acknowledge. 1 = link code word received from partner, 0 = link code word not yet received Note: This bit will always read 0	RO	0
13	Remote Fault. 1 = remote fault detected, 0 = no remote fault	RO	0
12	Reserved	RO	0
11:10	Pause Operation. 00 No PAUSE supported by partner station 01 Symmetric PAUSE supported by partner station 10 Asymmetric PAUSE supported by partner station 11 Both Symmetric PAUSE and Asymmetric PAUSE supported by partner station	RO	00
9	100Base-T4. 1 = T4 able, 0 = no T4 ability	RO	0
8	100Base-TX Full Duplex. 1 = TX with full duplex, 0 = no TX full duplex ability	RO	0
7	100Base-TX. 1 = TX able, 0 = no TX ability	RO	0
6	10Base-T Full Duplex. 1 = 10 Mbps with full duplex, 0 = no 10 Mbps with full duplex ability	RO	0
5	10Base-T. 1 = 10 Mbps able, 0 = no 10 Mbps ability	RO	0
4:0	Selector Field. [00001] = IEEE 802.3	RO	00001

5.5.7 Auto-negotiation Expansion

Index (In Decimal): 6 Size: 16-bits

BITS	DESCRIPTION	TYPE	DEFAULT
15:5	Reserved	RO	0
4	Parallel Detection Fault. 1 = fault detected by parallel detection logic 0 = no fault detected by parallel detection logic	RO/LH	0
3	Link Partner Next Page Able. 1 = link partner has next page ability 0 = link partner does not have next page ability	RO	0
2	Next Page Able. 1 = local device has next page ability 0 = local device does not have next page ability	RO	0
1	Page Received. 1 = new page received 0 = new page not yet received	RO/LH	0
0	Link Partner Auto-Negotiation Able. 1 = link partner has auto-negotiation ability 0 = link partner does not have auto-negotiation ability	RO	0

5.5.8 Mode Control/Status

Index (In Decimal): 17 Size: 16-bits

BITS	DESCRIPTION	TYPE	DEFAULT
15:14	Reserved. Write as 0; ignore on read.	RW	0
13	EDPWRDOWN. Enable the Energy Detect Power-Down mode: 0=Energy Detect Power-Down is disabled 1=Energy Detect Power-Down is enabled	RW	0
12:2	Reserved. Write as 0, ignore on read	RW	0
1	ENERGYON. Indicates whether energy is detected. This bit goes to a "0" if no valid energy is detected within 256ms. Reset to "1" by hardware reset, unaffected by SW reset.	RO	See Note 5.5
0	Reserved. Write as "0". Ignore on read.	RW	0

Note 5.5 The default value of this bit will vary dependant on the current link state of the line.

5.5.9 Special Modes

Index (In Decimal): 18 Size: 16-bits

ADDRESS	DESCRIPTION	TYPE	DEFAULT
15:8	Reserved	RW, NASR	
7:5	MODE: PHY Mode of operation. Refer to Table 5.9 for more details.	RW, NASR	See Table 5.9
4:0	PHYAD: PHY Address: The PHY Address is used for the SMI address.	RW, NASR	00001b

Table 5.9 MODE Control

MODE	MODE DEFINITIONS	DEFAULT REGISTER BIT VALUES	
		REGISTER 0	REGISTER 4
		[13,12,10,8]	[8,7,6,5]
000	10Base-T Half Duplex. Auto-negotiation disabled.	0000	N/A
001	10Base-T Full Duplex. Auto-negotiation disabled.	0001	N/A
010	100Base-TX Half Duplex. Auto-negotiation disabled. CRS is active during Transmit & Receive.	1000	N/A
011	100Base-TX Full Duplex. Auto-negotiation disabled. CRS is active during Receive.	1001	N/A
100	100Base-TX Half Duplex is advertised. Auto-negotiation enabled. CRS is active during Transmit & Receive.	1100	0100
101	Repeater mode. Auto-negotiation enabled. 100Base-TX Half Duplex is advertised. CRS is active during Receive.	1100	0100
110	Reserved - Do not set the LAN89218 in this mode.	N/A	N/A
111	All capable. Auto-negotiation enabled.	X10X Note 5.6	1111

Note 5.6 When MODE=111, the register 0 bits 13 and 8 are variable dependant on the auto-negotiated speed and duplex.

5.5.10 Special Control/Status Indications

Index (In Decimal): 27 Size: 16-bits

ADDRESS	DESCRIPTION	MODE	DEFAULT
15	Override AMDIX Strap 0 - AMDIX_EN pin enables or disables HP Auto MDIX 1 - Override AMDIX_EN pin. PHY Register 27.14 and 27.13 determine MDIX function	RW	0
14	Auto-MDIX Enable: Only effective when 27.15 = 1, otherwise ignored. 0 = Disable Auto-MDIX. 27.13 determines normal or reversed connection. 1 = Enable Auto-MDIX. 27.13 must be set to 0.	RW	0
13	Auto-MDIX State. Only effective when 27.15 = 1, otherwise ignored. When 27.14 = 0 (manually set MDIX state): 0 = no crossover (TPO = output, TPI = input) 1 = crossover (TPO = input, TPI = output) When 27.14 = 1 (automatic MDIX) this bit must be set to 0. Do not use the combination 27.15 = 1, 27.14 = 1, 27.13 = 1.	RW	0
12:11	Reserved. Write as 0. Ignore on read.	RW	0
10	VCOFF_LP: Forces the Receive PLL 10M to lock on the reference clock at all times: 0 - Receive PLL 10M can lock on reference or line as needed (normal operation) 1 - Receive PLL 10M is locked on the reference clock. In this mode 10M data packets cannot be received.	RW, NASR	0
9:5	Reserved. Write as 0. Ignore on read.	RW	0
4	XPOL: Polarity state of the 10Base-T: 0 - Normal polarity 1 - Reversed polarity	RO	0
3:0	Reserved. Read only - Writing to these bits have no effect.	RO	XXXXb

5.5.11 Interrupt Source Flag

Index (In Decimal): 29 Size: 16-bits

BITS	DESCRIPTION	TYPE	DEFAULT
15:8	Reserved. Ignore on read.	RO/LH	0
7	INT7. 1 = ENERGYON generated, 0 = not source of interrupt	RO/LH	0
6	INT6. 1 = Auto-Negotiation complete, 0 = not source of interrupt	RO/LH	0
5	INT5. 1 = Remote Fault Detected, 0 = not source of interrupt	RO/LH	0
4	INT4. 1 = Link Down (link status negated), 0 = not source of interrupt	RO/LH	See Note 5.7
3	INT3. 1 = Auto-Negotiation LP Acknowledge, 0 = not source of interrupt	RO/LH	0
2	INT2. 1 = Parallel Detection Fault, 0 = not source of interrupt	RO/LH	0
1	INT1. 1 = Auto-Negotiation Page Received, 0 = not source of interrupt	RO/LH	0
0	Reserved	RO/LH	0

Note 5.7 The default value of this bit will vary dependant on the current link state of the line.

5.5.12 Interrupt Mask

Index (In Decimal): 30 Size: 16-bits

BITS	DESCRIPTION	TYPE	DEFAULT
15:8	Reserved. Write as 0; ignore on read.	RO	0
7:0	Mask Bits. 1 = interrupt source is enabled, 0 = interrupt source is masked	RW	0

5.5.13 PHY Special Control/Status

Index (In Decimal): 31 Size: 16-bits

BITS	DESCRIPTION	TYPE	DEFAULT
15:13	Reserved	RO	000b
12	Autodone. Auto-negotiation done indication: 0 = Auto-negotiation is not done or disabled (or not active) 1 = Auto-negotiation is done	RO	0b
11:5	Reserved. Write as 0000010b, ignore on Read.	RW	0000010b
4:2	Speed Indication. HCDSPEED value: [001]=10 Mbps half-duplex [101]=10 Mbps full-duplex [010]=100Base-TX half-duplex [110]=100Base-TX full-duplex	RO	See Note 5.8
1:0	Reserved. Write as 0; ignore on Read	RO	00b

Note 5.8 See [Table 2.5, "Default Ethernet Settings,"](#) on [page 21](#), for default settings.

Chapter 6 Timing Diagrams

6.1 Host Interface Timing

The LAN89218 supports the following host cycles:

Read Cycles:

- PIO Reads (nCS or nRD controlled)
- PIO Burst Reads (nCS or nRD controlled)
- RX Data FIFO Direct PIO Reads (nCS or nRD controlled)
- RX Data FIFO Direct PIO Burst Reads (nCS or nRD controlled)

Write Cycles:

- PIO writes (nCS and nWR controlled)
- TX Data FIFO direct PIO writes (nCS or nWR controlled)

Note: Unless otherwise noted, timing specifications assume a load capacitance of 25 pF and are valid over the operating conditions specified in [Section 7.2, "Operating Conditions**"](#).

6.1.1 Special Restrictions on Back-to-Back Write/Read Cycles

It is important to note that there are specific restrictions on the timing of back-to-back write-read operations. These restrictions concern reading the control registers after any write cycle to the LAN89218 device. In many cases there is a required minimum delay between writing to the LAN89218, and the subsequent side effect (change in the control register value). For example, when writing to the TX Data FIFO, it takes up to 135 ns for the level indication to change in the TX_FIFO_INF register.

In order to prevent the host from reading stale data after a write operation, minimum wait periods must be enforced. These periods are specified in [Table 6.1, "Read After Write Timing Rules"](#). The host processor is required to wait the specified period of time after any write to the LAN89218 before reading the resource specified in the table. These wait periods are for read operations that immediately follow any write cycle. Note that the required wait period is dependant upon the register being read after the write.

Performing "dummy" reads of the BYTE_TEST register is a convenient way to guarantee that the minimum write-to-read timing restriction is met. [Table 6.1](#) also shows the number of dummy reads that are required before reading the register indicated. The number of BYTE_TEST reads in this table is based on the minimum timing for Tcycle (45 ns). For microprocessors with slower busses the number of reads may be reduced as long as the total time is equal to, or greater than the time specified in the table. Note that dummy reads of the BYTE_TEST register are not required as long as the minimum time period is met.

Table 6.1 Read After Write Timing Rules

REGISTER NAME	MINIMUM WAIT TIME FOR READ FOLLOWING ANY WRITE CYCLE (IN ns)	NUMBER OF BYTE_TEST READS (ASSUMING T_{cycle} OF 45 ns)
ID_REV	0	0
IRQ_CFG	135	3
INT_STS	90	2
INT_EN	45	1
BYTE_TEST	0	0
FIFO_INT	45	1
RX_CFG	45	1
TX_CFG	45	1
HW_CFG	45	1
RX_DP_CTRL	45	1
RX_FIFO_INF	0	0
TX_FIFO_INF	135	3
PMT_CTRL	315	7
GPIO_CFG	45	1
GPT_CFG	45	1
GPT_CNT	135	3
WORD_SWAP	45	1
FREE_RUN	180	4
RX_DROP	0	0
MAC_CSR_CMD	45	1
MAC_CSR_DATA	45	1
AFC_CFG	45	1
E2P_CMD	45	1
E2P_DATA	45	1

6.1.2 Special Restrictions on Back-to-Back Read Cycles

There are also restrictions on specific back-to-back read operations. These restrictions concern reading specific registers after reading resources that have side effects. In many cases there is a delay between reading the LAN89218, and the subsequent indication of the expected change in the control register values.

In order to prevent the host from reading stale data on back-to-back reads, minimum wait periods have been established. These periods are specified in [Table 6.2, "Read After Read Timing Rules"](#). The host processor is required to wait the specified period of time between read operations of specific combinations of resources. The wait period is dependant upon the combination of registers being read.

Performing "dummy" reads of the BYTE_TEST register is a convenient way to guarantee that the minimum wait time restriction is met. [Table 6.2](#) also shows the number of dummy reads that are required for back-to-back read operations. The number of BYTE_TEST reads in this table is based on the minimum timing for T_{cycle} (45 ns). For microprocessors with slower busses the number of reads may be reduced as long as the total time is equal to, or greater than the time specified in the table. Dummy reads of the BYTE_TEST register are not required as long as the minimum time period is met.

Table 6.2 Read After Read Timing Rules

AFTER READING...	WAIT FOR THIS MANY ... ns	OR PERFORM THIS MANY READS OF BYTE_TEST... (ASSUMING T_{cycle} OF 45 ns)	BEFORE READING ...
RX Data FIFO	135	3	RX_FIFO_INF
RX Status FIFO	135	3	RX_FIFO_INF
TX Status FIFO	135	3	TX_FIFO_INF
RX_DROP	180	4	RX_DROP

6.2 PIO Reads

PIO reads can be used to access CSRs or RX Data and RX/TX status FIFOs. In this mode, counters in the CSRs are latched at the beginning of the read cycle. Read data is valid as indicated in the timing diagram. PIO reads can be performed using Chip Select (nCS) or Read Enable (nRD). Either or both of these control signals must go high between cycles for the period specified.

PIO reads are supported for both 16- and 32-bit access. Timing for 16-bit and 32-bit PIO Read cycles is identical with the exception that D[31:16] are not driven during a 16-bit read.

Note: Some registers have restrictions on the timing of back-to-back, write-read and read-read cycles.

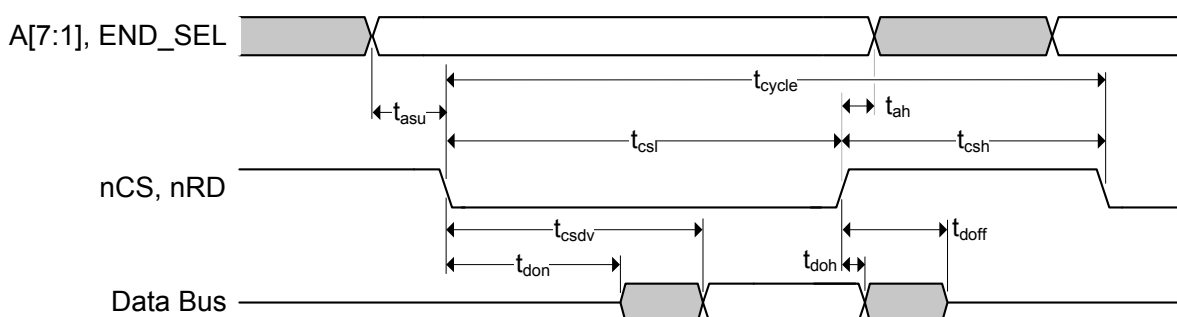

Figure 6.1 PIO Read Cycle Timing

Note: The “Data Bus” width is 32 bits with optional support for 16-bit bus widths.

Table 6.3 PIO Read Timing

SYMBOL	DESCRIPTION	MIN	TYP	MAX	UNITS
t_{cycle}	Read Cycle Time	45			ns
t_{csl}	nCS, nRD Assertion Time	32			ns
t_{csh}	nCS, nRD Deassertion Time	13			ns
t_{csdv}	nCS, nRD Valid to Data Valid			30	ns
t_{asu}	Address, END_SEL Setup to nCS, nRD Valid	0			ns
t_{ah}	Address, END_SEL Hold Time	0			ns
t_{don}	Data Buffer Turn On Time	0			ns
t_{doff}	Data Buffer Turn Off Time			7	ns
t_{doh}	Data Output Hold Time	0			ns

Note: A PIO Read cycle begins when both nCS and nRD are asserted. The cycle ends when either or both nCS and nRD are deasserted. They may be asserted and deasserted in any order.

6.3 PIO Burst Reads

In this mode, performance is improved by allowing up to 8 DWORD read cycles, or 16 WORD read cycles back-to-back. PIO Burst Reads can be performed using Chip Select (nCS) or Read Enable (nRD). Either or both of these control signals must go high between bursts for the period specified. Timing for 16-bit and 32-bit PIO Burst Mode Read cycles is identical, with the exception that D[31:16] are not driven during a 16-bit burst.

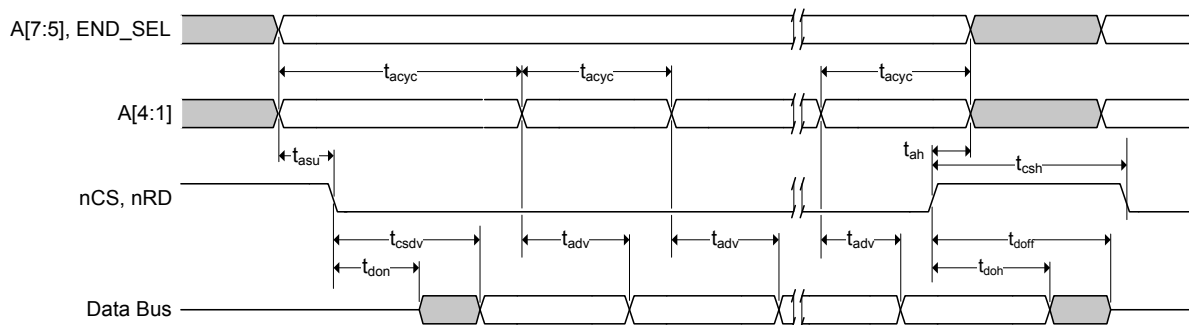

Figure 6.2 PIO Burst Read Cycle Timing

Note: The “Data Bus” width is 32 bits with optional support for 16-bit bus widths.

Table 6.4 PIO Burst Read Timing

SYMBOL	DESCRIPTION	MIN	TYP	MAX	UNITS
t_{csh}	nCS, nRD Deassertion Time	13			ns
t_{csdv}	nCS, nRD Valid to Data Valid			30	ns
t_{acyc}	Address Cycle Time	45			
t_{asu}	Address, END_SEL Setup to nCS, nRD valid	0			ns
t_{adv}	Address Stable to Data Valid			40	
t_{ah}	Address, END_SEL Hold Time	0			ns
t_{don}	Data Buffer Turn On Time	0			ns
t_{doff}	Data Buffer Turn Off Time			7	ns
t_{doh}	Data Output Hold Time	0			ns

Note: A PIO Burst Read cycle begins when both nCS and nRD are asserted. The cycle ends when either or both nCS and nRD are deasserted. They may be asserted and deasserted in any order.

6.4 RX Data FIFO Direct PIO Reads

In this mode, the upper address inputs are not decoded and any read of the LAN89218 will read the RX Data FIFO. This mode is enabled when FIFO_SEL is driven high during a read access. This is normally accomplished by connecting the FIFO_SEL signal to high-order address line. This mode is useful when the host processor must increment its address when accessing the LAN89218. Timing is identical to a PIO read, and the FIFO_SEL signal has the same timing characteristics as the address lines.

Timing for 16-bit and 32-bit Direct PIO Read cycles is identical with the exception that D[31:16] is not driven during a 16-bit read. Note that address lines A[2:1] are still used, and address bits A[7:3] are ignored.

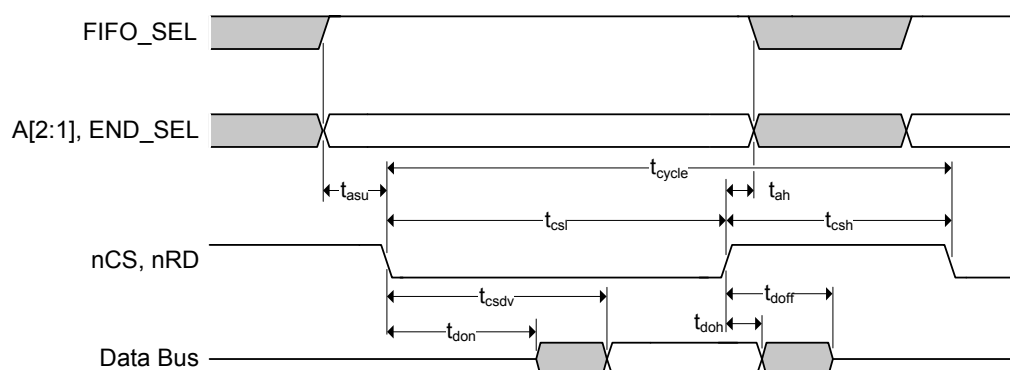

Figure 6.3 RX Data FIFO Direct PIO Read Cycle Timing

Note: The “Data Bus” width is 32 bits with optional support for 16-bit bus widths.

Table 6.5 RX Data FIFO Direct PIO Read Timing

SYMBOL	DESCRIPTION	MIN	TYP	MAX	UNITS
t_{cycle}	Read Cycle Time	45			ns
t_{csl}	nCS, nRD Assertion Time	32			ns
t_{csh}	nCS, nRD Deassertion Time	13			ns
t_{csdv}	nCS, nRD Valid to Data Valid			30	ns
t_{asu}	Address, END_SEL, FIFO_SEL Setup to nCS, nRD Valid	0			ns
t_{ah}	Address, END_SEL, FIFO_SEL Hold Time	0			ns
t_{don}	Data Buffer Turn On Time	0			ns
t_{doff}	Data Buffer Turn Off Time			7	ns
t_{doh}	Data Output Hold Time	0			ns

Note: An RX Data FIFO Direct PIO Read cycle begins when both nCS and nRD are asserted. The cycle ends when either or both nCS and nRD are de-asserted. They may be asserted and de-asserted in any order.

6.5 RX Data FIFO Direct PIO Burst Reads

In this mode the upper address inputs are not decoded, and any burst read of the LAN89218 will read the RX Data FIFO. This mode is enabled when FIFO_SEL is driven high during a read access. This is normally accomplished by connecting the FIFO_SEL signal to a high-order address line. This mode is useful when the host processor must increment its address when accessing the LAN89218. Timing is identical to a PIO Burst Read, and the FIFO_SEL signal has the same timing characteristics as the address lines. This mode improves performance by allowing an unlimited number of back-to-back read cycles. RX Data FIFO Direct PIO Burst Reads can be performed using Chip Select (nCS) or Read Enable (nRD). When either or both of these control signals go high, they must remain high for the period specified.

Timing for 16-bit and 32-bit RX Data FIFO Direct PIO Burst Reads is identical with the exception that D[31:16] are not driven during a 16-bit burst. Note that address lines A[2:1] are still used, and address bits A[7:3] are ignored.

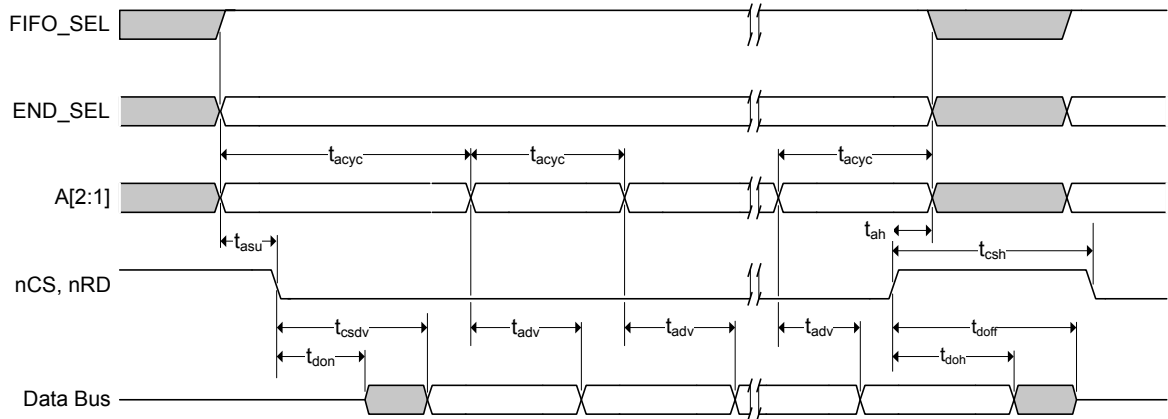

Figure 6.4 RX Data FIFO Direct PIO Burst Read Cycle Timing

Note: The “Data Bus” width is 32 bits with optional support for 16-bit bus widths.

Table 6.6 RX Data FIFO Direct PIO Burst Read Cycle Timing

SYMBOL	DESCRIPTION	MIN	TYP	MAX	UNITS
t_{csh}	nCS, nRD Deassertion Time	13			ns
t_{csdv}	nCS, nRD Valid to Data Valid			30	ns
t_{acyc}	Address Cycle Time	45			
t_{asu}	Address, END_SEL, FIFO_SEL Setup to nCS, nRD Valid	0			ns
t_{adv}	Address Stable to Data Valid			40	
t_{ah}	Address, END_SEL, FIFO_SEL Hold Time	0			ns
t_{don}	Data Buffer Turn On Time	0			ns
t_{doff}	Data Buffer Turn Off Time			7	ns
t_{doh}	Data Output Hold Time	0			ns

Note: An RX Data FIFO Direct PIO Burst Read cycle begins when both nCS and nRD are asserted. The cycle ends when either or both nCS and nRD are deasserted. They may be asserted and deasserted in any order.

6.6 PIO Writes

PIO writes are used for all LAN89218 write cycles. PIO writes can be performed using Chip Select (nCS) or Write Enable (nWR). Either or both of these control signals must go high between cycles for the period specified.

PIO Writes are valid for 16- and 32-bit access. Timing for 16-bit and 32-bit PIO write cycles are identical with the exception that D[31:16] are ignored during a 16-bit write.

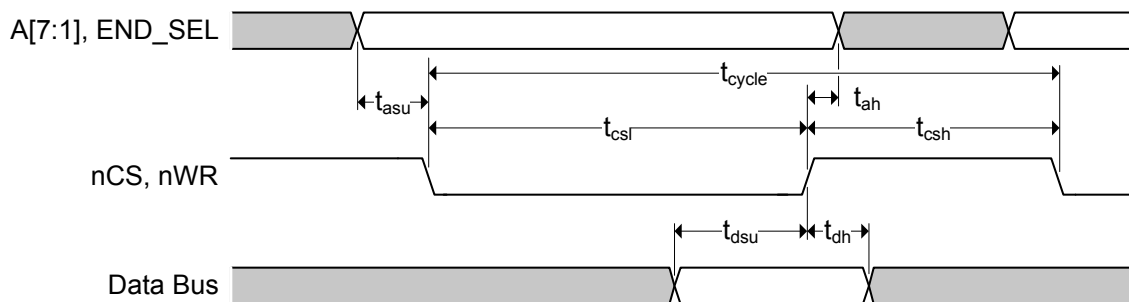

Figure 6.5 PIO Write Cycle Timing

Note: The “Data Bus” width is 32 bits with optional support for 16-bit bus widths.

Table 6.7 PIO Write Cycle Timing

SYMBOL	DESCRIPTION	MIN	TYP	MAX	UNITS
t_{cycle}	Write Cycle Time	45			ns
t_{csl}	nCS, nWR Assertion Time	32			ns
t_{csh}	nCS, nWR Deassertion Time	13			ns
t_{asu}	Address, END_SEL Setup to nCS, nWR Assertion	0			ns
t_{ah}	Address, END_SEL Hold Time	0			ns
t_{dsu}	Data Setup to nCS, nWR Deassertion	7			ns
t_{dh}	Data Hold Time	0			ns

Note: A PIO Write cycle begins when both nCS and nWR are asserted. The cycle ends when either or both nCS and nWR are deasserted. They may be asserted and deasserted in any order.

6.7 TX Data FIFO Direct PIO Writes

In this mode the upper address inputs are not decoded, and any write to the LAN89218 will write the TX Data FIFO. This mode is enabled when FIFO_SEL is driven high during a write access. This is normally accomplished by connecting the FIFO_SEL signal to a high-order address line. This mode is useful when the host processor must increment its address when accessing the LAN89218. Timing is identical to a PIO write, and the FIFO_SEL signal has the same timing characteristics as the address lines.

Timing for 16-bit and 32-bit cycles is identical with the exception that D[31:16] is ignored during a 16-bit write. Note that address lines A[2:1] are still used when the LAN89218 is operating in 32-bit and 16-bit mode. Address bits A[7:3] are ignored.

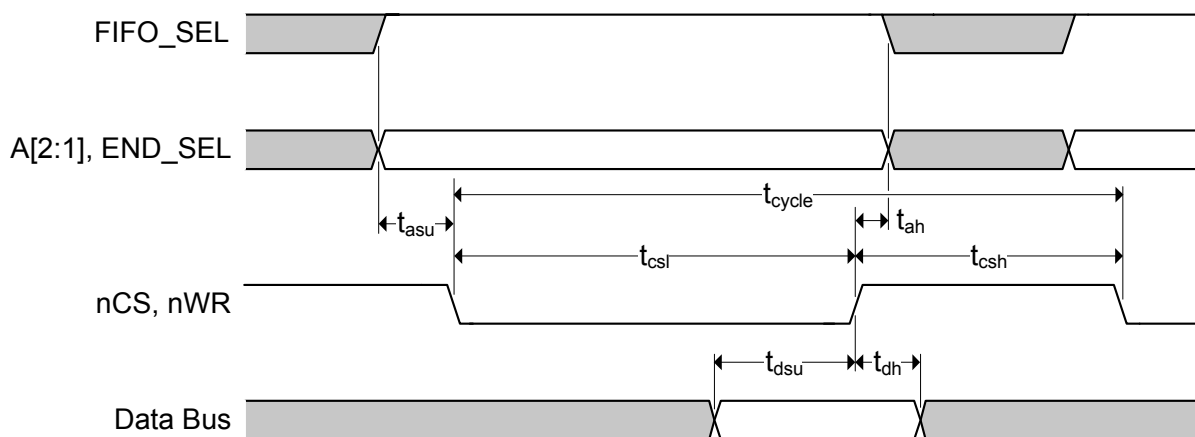

Figure 6.6 TX Data FIFO Direct PIO Write Timing

Note: The “Data Bus” width is 32 bits with optional support for 16-bit bus widths.

Table 6.8 TX Data FIFO Direct PIO Write Timing

SYMBOL	DESCRIPTION	MIN	TYP	MAX	UNITS
t_{cycle}	Write Cycle Time	45			ns
t_{csl}	nCS, nWR Assertion Time	32			ns
t_{csh}	nCS, nWR Deassertion Time	13			ns
t_{asu}	Address, END_SEL, FIFO_SEL Setup to nCS, nWR Assertion	0			ns
t_{ah}	Address, END_SEL, FIFO_SEL Hold Time	0			ns
t_{dsu}	Data Setup to nCS, nWR Deassertion	7			ns
t_{dh}	Data Hold Time	0			ns

Note: A TX Data FIFO Direct PIO Write cycle begins when both nCS and nWR are asserted. The cycle ends when either or both nCS and nWR are deasserted. They may be asserted and deasserted in any order.

6.8 nRESET Timing

This diagram illustrates the nRESET pin timing requirements and its relation to the configuration strap pins. When used, it must be asserted for the minimum period specified. Refer to [Section 3.11, "Detailed Reset Description,"](#) on page 52 for additional information.

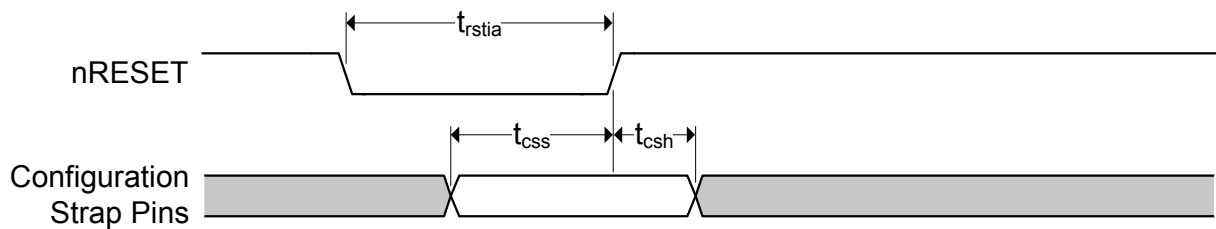

Figure 6.7 nRESET Reset Pin Timing

Table 6.9 nRESET Reset Pin Timing Values

SYMBOL	DESCRIPTION	MIN	TYP	MAX	UNITS
t_{rstia}	nRESET input assertion time	200			μs
t_{css}	Configuration strap pins setup to nRESET deassertion	200			ns
t_{csh}	Configuration strap pins hold after nRESET deassertion	10			ns

Note: Device configuration straps are latched as a result of nRESET assertion.

6.9 EEPROM Timing

The following specifies the EEPROM timing requirements for the LAN89218:

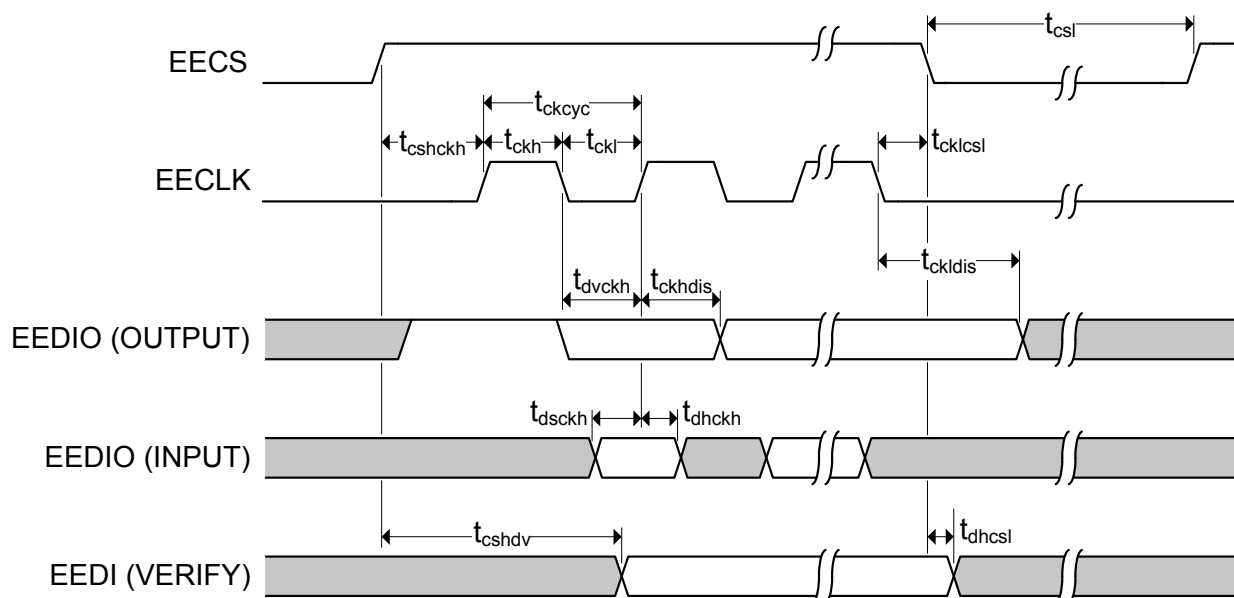

Figure 6.8 EEPROM Timing

Table 6.10 EEPROM Timing Values

SYMBOL	DESCRIPTION	MIN	TYP	MAX	UNITS
t_{ckcyc}	EECLK Cycle time	1110		1130	ns
t_{ckh}	EECLK High time	550		570	ns
t_{ckl}	EECLK Low time	550		570	ns
t_{cshckh}	EECS high before rising edge of EECLK	1070			ns
t_{cklcsl}	EECLK falling edge to EECS low	30			ns
t_{dvckh}	EEDIO valid before rising edge of EECLK (OUTPUT)	550			ns
t_{ckhdis}	EEDIO disable after rising edge EECLK (OUTPUT)	550			ns
t_{dsckh}	EEDIO setup to rising edge of EECLK (INPUT)	90			ns
t_{dhckh}	EEDIO hold after rising edge of EECLK (INPUT)	0			ns
t_{ckldis}	EECLK low to data disable (OUTPUT)	580			ns
t_{cshdv}	EEDIO valid after EECS high (VERIFY)			600	ns
t_{dhcsl}	EEDIO hold after EECS low (VERIFY)	0			ns
t_{csl}	EECS low	1070			ns

Chapter 7 Operational Characteristics

Specifications are subject to change without notice.

7.1 Absolute Maximum Ratings*

Supply voltage (VDD_A, VDD_REF, VREG, VDD_IO)	0 V to +3.6 V
Positive voltage on signal pins, with respect to ground (Note 7.1)	+6.0 V
Negative voltage on signal pins, with respect to ground (Note 7.2)	-0.5 V
Positive voltage on XTAL1/CLKIN, with respect to ground	+4.6 V
Positive voltage on XTAL2, with respect to ground	+2.5 V
Storage temperature	-65 °C to +150 °C
Junction temperature.	+150 °C
Lead temperature range	Refer to JEDEC Spec. J-STD-020

*Operation at or above these limits may damage the device.

Note 7.1 This rating does not apply to the following pins: XTAL1/CLKIN, XTAL2, EXRES1.

Note 7.2 This rating does not apply to the following pins: EXRES1.

7.2 Operating Conditions**

Supply voltage (VDD_A, VDD_REF, VREG, VDD_IO)	+3.3 V \pm 300 mV
Junction temperature.	-40 °C to +125 °C

**Proper operation of the LAN89218 is guaranteed only within the ranges specified in this section.

7.3 Package Thermal Specifications

Table 7.1 Package Thermal Parameters

PARAMETER	SYMBOL	VALUE	UNITS	COMMENTS
Thermal Resistance	Θ_{JA}	35	°C/W	Measured from the die to ambient air.
Junction-to-Top-of-Package	Ψ_{JT}	1.25	°C/W	

Note: Thermal parameters are measured or estimated for devices in a multilayer 2S2P PCB per JESD51.

7.4 Power Consumption (Device Only)

This section provides typical power consumption values for the LAN89218 in various modes of operation. These measurements were taken under the following conditions:

Temperature: +25 °C

Device VDD: +3.30 V

Table 7.2 Power Consumption Device Only

MODE	Total Power - Typical (mW)
10BASE-T Operation	
D0, 10BASE-T /w traffic	295
D0, Idle	290
D1, Idle	175
D2, Energy Detect Power Down	64
D2, General Power Down	12
100BASE-TX Operation	
D0, 100BASE-TX /w traffic	420
D0, Idle	415
D1, Idle	300
D2, Energy Detect Power Down	64
D2, General Power Down	12

Note: D0 = Normal Operation, D1 = WOL (Wake On LAN mode), D2 = Low Power Energy Detect.

7.5 Power Consumption (Device and System Components)

This section provides typical power consumption values for a complete Ethernet interface based on the LAN89218, including the power dissipated by the magnetics and other passive components.

Note: The power measurements list below were taken under the following conditions:

Temperature: +25 °C

Device VDD: +3.30 V

Table 7.3 Power Consumption Device and System Components

MODE	Total Power - Typical (mW)
10BASE-T Operation	
D0, 10BASE-T /w traffic	655
D0, Idle	650
D1, Idle	535
D2, Energy Detect Power Down	64
D2, General Power Down	12
100BASE-TX Operation	
D0, 100BASE-TX /w traffic	565
D0, Idle	560
D1, Idle	445
D2, Energy Detect Power Down	64
D2, General Power Down	12

7.6 DC Electrical Specifications

Table 7.4 below lists the worst case current consumption for each of the supplies of the LAN89218. These figures are provided to assist system designers properly design the power supply; they cannot be used to determine typical power consumption of the device.

Note: Unless otherwise noted, the DC specifications in this section are valid over the operating conditions specified in Section 7.2, "Operating Conditions**".

Table 7.4 Supply Current Characteristics

PARAMETER	SUPPLY NAME	MIN	TYP	MAX	UNITS	NOTES
Internal Regulator Supply Current	VREG			80	mA	
+3.3 V I/O Supply Current	VDD_IO			15	mA	
+3.3 V Analog Supply Current	VDD_A			50	mA	
Reference Supply Current	VDD_REF			30	mA	

Note: Above figures do not include the supply current for the magnetics. Based on the recommended implementation, the maximum supply current needed for the magnetics is 108 mA.

Table 7.5 I/O Buffer Characteristics

PARAMETER	SYMBOL	MIN	TYP	MAX	UNITS	NOTES
I Type Input Buffer						
Low Input Level	V_{ILI}	-0.3		0.8	V	
High Input Level	V_{IHI}	2.0		5.5	V	
Rise/Fall Time	t_{RF}			20	ns	Measured between V_{ILI} and V_{IHI}
Input Leakage ($V_{IN} = GND_IO$ or VDD_IO)	I_{IH}	-10		10	μ A	Note 7.3
Input Leakage ($V_{IN} = 5.5$ V)	I_{IH}			750	μ A	Note 7.3, Note 7.4
Input Capacitance	C_{IN}			3.3	pF	

Table 7.5 I/O Buffer Characteristics (continued)

PARAMETER	SYMBOL	MIN	TYP	MAX	UNITS	NOTES
IS Type Input Buffer						
Negative-Going Threshold	V_{ILT}	0.9	1.2	1.45	V	Schmitt Trigger
Positive-Going Threshold	V_{IHT}	1.4	1.6	1.95	V	Schmitt Trigger
Schmitt Trigger Hysteresis ($V_{IHT} - V_{ILT}$)	V_{HYS}	345	420	650	mV	
Input Leakage ($V_{IN} = GND_{IO}$ or VDD_{IO})	I_{IH}	-10		10	μ A	Note 7.3
Input Leakage ($V_{IN} = 5.5$ V)	I_{IH}			750	μ A	Note 7.3, Note 7.4
Input Capacitance	C_{IN}			3.3	pF	
O12 Type Buffer						
Low Output Level	V_{OL}			0.48	V	$I_{OL} = 12$ mA
High Output Level	V_{OH}	VDD - 0.5			V	$I_{OH} = -12$ mA
OD12 Type Buffer						
Low Output Level	V_{OL}			0.48	V	$I_{OL} = 12$ mA
OD8 Type Buffer						
Low Output Level	V_{OL}			0.48	V	$I_{OL} = 8$ mA
O8 Type Buffer						
Low Output Level	V_{OL}			0.48	V	$I_{OL} = 8$ mA
High Output Level	V_{OH}	VDD - 0.5			V	$I_{OH} = -8$ mA
I_{CLK} Input Buffer						
Low Input Level	V_{ILCK}	-0.3		0.5	V	
High Input Level	V_{IHCK}	1.4		3.6	V	

Note 7.3 This specification applies to all inputs and tri-stated bi-directional pins. Internal pull-down and pull-up resistors add ± 50 μ A per-pin (typical).

Note 7.4 This is the total V_{IN} input leakage for the entire device. This value should be divided by the number of pins driven to V_{IN} MAX to calculate per-pin leakage. For example, if 10 pins are driven to the maximum operational limit for V_{IN} , the per-pin input leakage is the maximum input leakage current divided by 10.

Table 7.6 100BASE-TX Transceiver Characteristics

PARAMETER	SYMBOL	MIN	TYP	MAX	UNITS	NOTES
Peak Differential Output Voltage High	V_{PPH}	950		1050	mVpk	Note 7.5
Peak Differential Output Voltage Low	V_{PPL}	-950		-1050	mVpk	Note 7.5
Signal Amplitude Symmetry	V_{SS}	98		102	%	Note 7.5
Signal Rise & Fall Time	T_{RF}	3.0		5.0	ns	Note 7.5
Rise & Fall Time Symmetry	T_{RFS}			0.5	ns	Note 7.5
Duty Cycle Distortion	D_{CD}			± 250	ps	Note 7.6
Overshoot & Undershoot	V_{OS}		4.2		%	
Jitter				1.4	ns	Note 7.7

Note 7.5 Measured at the line side of the transformer, line replaced by 100 Ω ($\pm 1\%$) resistor.

Note 7.6 Offset from 16 ns pulse width at 50% of pulse peak.

Note 7.7 Measured differentially.

Table 7.7 10BASE-T Transceiver Characteristics

PARAMETER	SYMBOL	MIN	TYP	MAX	UNITS	NOTES
Transmitter Peak Differential Output Voltage	V_{OUT}	2.2	2.5	2.8	V	Note 7.8
Receiver Differential Squelch Threshold	V_{DS}		516		mV	

Note 7.8 Measured at the line side of the transformer, line replaced by 100 Ω ($\pm 1\%$) resistor.

7.7 Clock Circuit

The LAN89218 can accept either a 25 MHz crystal (preferred) or a 25 MHz single-ended clock oscillator (± 50 PPM) input. The LAN89218 shares the 25 MHz clock oscillator input (CLKIN) with the crystal input XTAL1/CLKIN. If the single-ended clock oscillator method is implemented, XTAL2 should be left unconnected and CLKIN should be driven with a nominal 0-3.3 V clock signal. The input clock duty cycle is 40% minimum, 50% typical and 60% maximum.

It is recommended that a crystal utilizing matching parallel load capacitors be used for the LAN89218 crystal input/output signals (XTAL1, XTAL2). See [Table 7.8, "LAN89218 Crystal Specifications"](#) for crystal specifications. Refer to application note AN10.7 - "Parallel Crystal Circuit Input Voltage Control" for additional information.

Table 7.8 LAN89218 Crystal Specifications

PARAMETER	SYMBOL	MIN	NOM	MAX	UNITS	NOTES
Crystal Cut		AT, typ				
Crystal Oscillation Mode		Fundamental Mode				
Crystal Calibration Mode		Parallel Resonant Mode				
Frequency	F_{fund}		25.000		MHz	
Frequency Tolerance @ 25 °C	F_{tol}			± 50	PPM	Note 7.9
Frequency Stability Over Temp	F_{temp}			± 50	PPM	Note 7.9
Frequency Deviation Over Time	F_{age}		± 3 to 5		PPM	Note 7.10
Total Allowable PPM Budget				± 50	PPM	Note 7.11
Shunt Capacitance	C_O		7 typ		pF	
Load Capacitance	C_L		20 typ		pF	
Drive Level	P_W	300			μW	
Equivalent Series Resistance	R_1			50	Ω	
Operating Temperature Range		-40		+85	$^{\circ}C$	
LAN89218 XTAL1/CLKIN Pin Capacitance			3 typ		pF	Note 7.12
LAN89218 XTAL2 Pin Capacitance			3 typ		pF	Note 7.12

Note 7.9 The maximum allowable values for Frequency Tolerance and Frequency Stability are application dependant. Since any particular application must meet the IEEE ± 50 PPM Total PPM Budget, the combination of these two values must be approximately ± 45 PPM (allowing for aging).

Note 7.10 Frequency Deviation Over Time is also referred to as Aging.

Note 7.11 The total deviation for the Transmitter Clock Frequency is specified by IEEE 802.3u as ± 50 PPM.

Note 7.12 This number includes the pad, the bond wire and the lead frame. PCB capacitance is not included in this value. The XTAL1/CLKIN and XTAL2 pin and PCB capacitance values are required to accurately calculate the value of the two external load capacitors. These two external load capacitors determine the accuracy of the 25.000 MHz frequency.

Chapter 8 Package Outline

8.1 100-TQFP Package

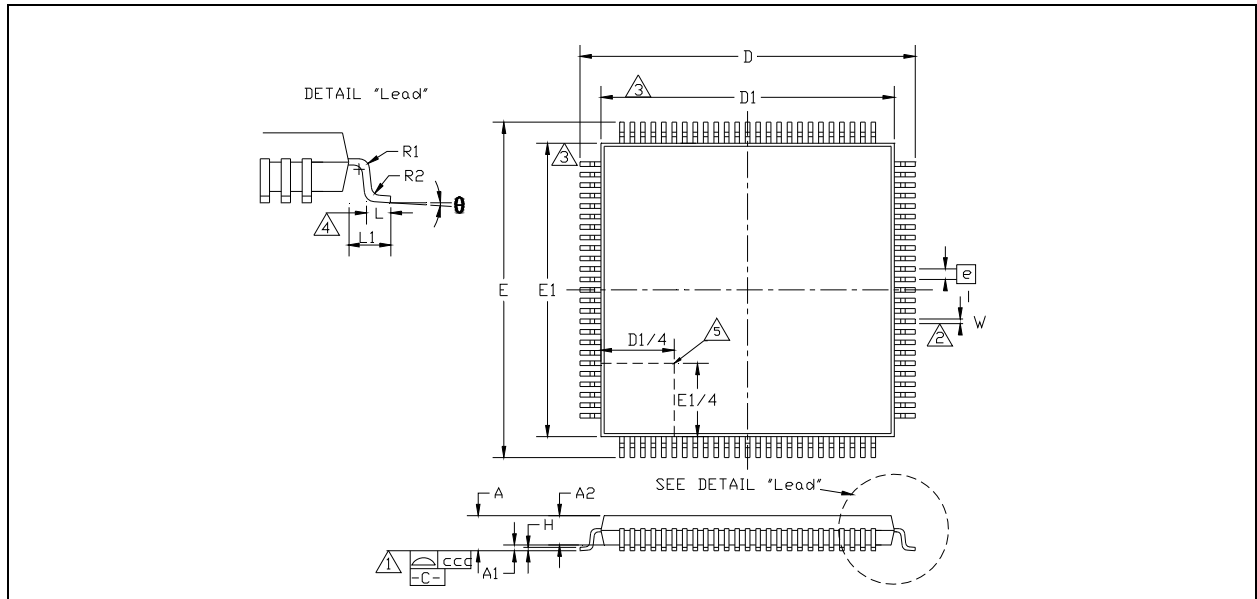

Figure 8.1 100-Pin TQFP Package Definition

Table 8.1 100-Pin TQFP Package Parameters

	MIN	NOMINAL	MAX	REMARKS
A	~	~	1.60	Overall Package Height
A1	0.05	~	0.15	Standoff
A2	1.35	~	1.45	Body Thickness
D	15.80	~	16.20	X Span
D1	13.80	~	14.20	X body Size
E	15.80	~	16.20	Y Span
E1	13.80	~	14.20	Y body Size
H	0.09	~	0.20	Lead Frame Thickness
L	0.45	0.60	0.75	Lead Foot Length
L1	~	1.00	~	Lead Length
e	0.50 Basic			Lead Pitch
q	0°	~	7°	Lead Foot Angle
W	0.17	0.22	0.27	Lead Width
R1	0.08	~	~	Lead Shoulder Radius
R2	0.08	~	0.20	Lead Foot Radius
ccc	~	~	0.08	Coplanarity

Notes:

1. Controlling Unit: millimeter.
2. Tolerance on the true position of the leads is ± 0.04 mm maximum.
3. Package body dimensions D1 and E1 do not include the mold protrusion. Maximum mold protrusion is 0.25 mm.
4. Dimension for foot length L measured at the gauge plane 0.25 mm above the seating plane.
5. Details of pin 1 identifier are optional but must be located within the zone indicated.

Chapter 9 Revision History

Table 9.1 Customer Revision History

REVISION LEVEL AND DATE	SECTION/FIGURE/ENTRY	CORRECTION
Revision A	<ul style="list-style-type: none"> ■ Replaces the previous SMSC version Rev. 1.4 ■ Removed confidentiality from document ■ Added Note and Trademark page ■ Added Worldwide Sales and Services page ■ Changed order numbers 	
Rev. 1.4 (07-22-11)	Table 2.4, "System and Power Signals," on page 19	nLED1 description modified to indicate that the signal is driven low when operating speed is 100 Mbs and is driven high during autonegotiation, when the cable is disconnected, and during 10 Mbs operation.
	Section 3.6.2.1, "TX Checksum Calculation," on page 36	Added note stating TX Checksum calculation should not be used for UDP packets under IPv6.
	Section 5.2.1, "RX FIFO Ports," on page 83	RX Data FIFO port is aliased to 16 WORD locations in 16-bit mode, not 16 DWORD locations.
	Section 5.2.2, "TX FIFO Ports," on page 84	TX Data FIFO port is aliased to 16 WORD locations in 16-bit mode, not 16 DWORD locations.
Rev. 1.3 (02-23-10)	Power-On Timing Diagram	Diagram removed. Refer to Section 3.11.1, "Power-On Reset (POR)," on page 53 for details on POR.
	Section 3.11.1, "Power-On Reset (POR)," on page 53	Added application note regarding configuration strap timing requirements
	Section 6.8, "nRESET Timing," on page 143	Fixed diagram error. Removed T_{odad} and output drive information
	Chapter 7, "Operational Characteristics," on page 145	Added specification disclaimer
	Table 7.4, "Supply Current Characteristics"	Changed PS current for 3.3 V I/O VDD_IO from 5 mA to 15 mA Changed PS current for VDD_REF from 25 mA to 30 mA
	Table 7.5, "I/O Buffer Characteristics," on page 148	Updated the following buffer characteristics: <ul style="list-style-type: none"> - IS neg-going threshold - IS pos-going threshold - IS input leakage - O12 low/high output levels - OD12 low output level - OD8 low output level - O8 low/high output level
	Table 7.6, "100BASE-TX Transceiver Characteristics," on page 150	Updated the overshoot & undershoot characteristics Changed Duty Cycle Distortion to ± 250 ps
Rev. 1.3 (02-23-10)	Table 7.7, "10BASE-T Transceiver Characteristics," on page 150	Updated the receiver differential squelch threshold characteristics

Table 9.1 Customer Revision History (continued)

REVISION LEVEL AND DATE	SECTION/FIGURE/ENTRY	CORRECTION
Rev. 1.24 (03-13-09)	All	Confidential designation removed from document
Rev. 1.23 (12-05-08)	Figure 2.1 Pin Configuration (Top View) on page 15	Updated top marking information.
	Table 8.1, "100-Pin TQFP Package Parameters," on page 152	Updated D1 and E1 min and max values.
Rev. 1.22 (11-24-08)	Section 7.3, "Package Thermal Specifications," on page 145	Updated theta JA and psi JT information.
Rev. 1.21 (11-21-08)	Section 7.1, "Absolute Maximum Ratings*," on page 145	Added absolute max junction temp. Updated section notes and formatting for clarity.
	Section 7.4, "Power Consumption (Device Only)," on page 146 and Section 7.5, "Power Consumption (Device and System Components)," on page 147	Updated values with latest data.
Rev. 1.2 (11-21-08)	All	Fixed various typos
	Table 7.8 on page 151	Updated crystal specifications: Drive Level: 300uW ESR 50 Ohms
Rev. 1.2 (11-21-08)	Section 5.3.23, "E2P_CMD – EEPROM Command Register," on page 107	Corrected MAC Address Loaded (bit 8) type from "RO" to "R/WC"
	Chapter 7, "Operational Characteristics," on page 145	Added HBM ESD value, thermal specifications, power numbers.
Rev. 1.0 (06-20-08)	Table 2.4, "System and Power Signals," on page 19	Fixed note cross-references in the VDD_CORE and VDD_PLL pin descriptions.
Rev. 1.0 (06-19-08)	Figure 1.2, "Internal Block Diagram"	Diagram redone to add PLL regulator block and add the word "core" to the original regulator block.
	Table 2.4, "System and Power Signals," on page 19	Added new note underneath table which is referenced in the VDD_CORE and VDD_PLL pin descriptions: "This pin must not be used to supply power to other external devices."
	Section 3.6, "Checksum Offload Engines (COE)," on page 32	Fixed pagination.
Rev. 1.0 (06-13-08)	Section 5.5.5, "Auto-negotiation Advertisement," on page 126	Bits 9 and 15 relabeled as Reserved, Read-Only (RO), with a default of 0.

Table 9.1 Customer Revision History (continued)

REVISION LEVEL AND DATE	SECTION/FIGURE/ENTRY	CORRECTION
Rev. 1.0 (06-13-08)	Section 5.5.5, "Auto-negotiation Advertisement," on page 126	Fixed definition of bits 11:10 when equal to "11" by adding "advertise support for.." to beginning of definition. Also added note stating "When both symmetric PAUSE and asymmetric PAUSE support are advertised, the device will only be configured to, at most, one of the two settings upon auto-negotiation completion." (Bugzilla Bug 1901)
	Section 5.3.1, "ID_REV—Chip ID and Revision," on page 85	Removed "0000" from the default value of the Chip Revision field. This was replaced with a cross-reference to a new note which states, "Default value is dependent on device revision."
	Section 3.5, "Wake-up Frame Detection," on page 29 and Section 5.4.1, "MAC_CR—MAC Control Register," on page 111	Added note: "When wake-up frame detection is enabled via the WUEN bit of the WUCSR—Wake-up Control and Status Register , a broadcast wake-up frame will wake-up the device despite the state of the Disable Broadcast Frame (BCAST) bit in the MAC_CR—MAC Control Register ."
	Section 5.4.12, "WUCSR—Wake-up Control and Status Register," on page 121	Fixed typo in bit 9: "... Mac Address [1:0] bit set to 0." was changed to "...Mac Address [0] bit set to 0."
	All	Fixed various typos

Note the following details of the code protection feature on Microchip devices:

- Microchip products meet the specification contained in their particular Microchip Data Sheet.
- Microchip believes that its family of products is one of the most secure families of its kind on the market today, when used in the intended manner and under normal conditions.
- There are dishonest and possibly illegal methods used to breach the code protection feature. All of these methods, to our knowledge, require using the Microchip products in a manner outside the operating specifications contained in Microchip's Data Sheets. Most likely, the person doing so is engaged in theft of intellectual property.
- Microchip is willing to work with the customer who is concerned about the integrity of their code.
- Neither Microchip nor any other semiconductor manufacturer can guarantee the security of their code. Code protection does not mean that we are guaranteeing the product as "unbreakable."

Code protection is constantly evolving. We at Microchip are committed to continuously improving the code protection features of our products. Attempts to break Microchip's code protection feature may be a violation of the Digital Millennium Copyright Act. If such acts allow unauthorized access to your software or other copyrighted work, you may have a right to sue for relief under that Act.

Information contained in this publication regarding device applications and the like is provided only for your convenience and may be superseded by updates. It is your responsibility to ensure that your application meets with your specifications. MICROCHIP MAKES NO REPRESENTATIONS OR WARRANTIES OF ANY KIND WHETHER EXPRESS OR IMPLIED, WRITTEN OR ORAL, STATUTORY OR OTHERWISE, RELATED TO THE INFORMATION, INCLUDING BUT NOT LIMITED TO ITS CONDITION, QUALITY, PERFORMANCE, MERCHANTABILITY OR FITNESS FOR PURPOSE. Microchip disclaims all liability arising from this information and its use. Use of Microchip devices in life support and/or safety applications is entirely at the buyer's risk, and the buyer agrees to defend, indemnify and hold harmless Microchip from any and all damages, claims, suits, or expenses resulting from such use. No licenses are conveyed, implicitly or otherwise, under any Microchip intellectual property rights.

Trademarks

The Microchip name and logo, the Microchip logo, dsPIC, FlashFlex, KEELOQ, KEELOQ logo, MPLAB, PIC, PICmicro, PICSTART, PIC³² logo, rPIC, SST, SST Logo, SuperFlash and UNI/O are registered trademarks of Microchip Technology Incorporated in the U.S.A. and other countries.

FilterLab, Hampshire, HI-TECH C, Linear Active Thermistor, MTP, SEEVAL and The Embedded Control Solutions Company are registered trademarks of Microchip Technology Incorporated in the U.S.A.

Silicon Storage Technology is a registered trademark of Microchip Technology Inc. in other countries.

Analog-for-the-Digital Age, Application Maestro, BodyCom, chipKIT, chipKIT logo, CodeGuard, dsPICDEM, dsPICDEM.net, dsPICworks, dsSPEAK, ECAN, ECONOMONITOR, FanSense, HI-TIDE, In-Circuit Serial Programming, ICSP, Mindi, MiWi, MPASM, MPF, MPLAB Certified logo, MPLIB, MPLINK, mTouch, Omniscient Code Generation, PICC, PICC-18, PICDEM, PICDEM.net, PICkit, PICtail, REAL ICE, rLAB, Select Mode, SQI, Serial Quad I/O, Total Endurance, TSHARC, UniWinDriver, WiperLock, ZENA and Z-Scale are trademarks of Microchip Technology Incorporated in the U.S.A. and other countries.

SQTP is a service mark of Microchip Technology Incorporated in the U.S.A.

GestIC and ULPP are registered trademarks of Microchip Technology Germany II GmbH & Co. KG, a subsidiary of Microchip Technology Inc., in other countries.

A more complete list of registered trademarks and common law trademarks owned by Standard Microsystems Corporation ("SMSC") is available at: www.smisc.com. The absence of a trademark (name, logo, etc.) from the list does not constitute a waiver of any intellectual property rights that SMSC has established in any of its trademarks.

All other trademarks mentioned herein are property of their respective companies.

© 2013, Microchip Technology Incorporated, Printed in the U.S.A., All Rights Reserved.

ISBN: 978-1-62077-692-6

**QUALITY MANAGEMENT SYSTEM
CERTIFIED BY DNV
= ISO/TS 16949 =**

Microchip received ISO/TS-16949:2009 certification for its worldwide headquarters, design and wafer fabrication facilities in Chandler and Tempe, Arizona; Gresham, Oregon and design centers in California and India. The Company's quality system processes and procedures are for its PIC[®] MCUs and dsPIC[®] DSCs, KEELOQ[®] code hopping devices, Serial EEPROMs, microperipherals, nonvolatile memory and analog products. In addition, Microchip's quality system for the design and manufacture of development systems is ISO 9001:2000 certified.

NOTES:



Worldwide Sales and Service

AMERICAS

Corporate Office
2355 West Chandler Blvd.
Chandler, AZ 85224-6199
Tel: 480-792-7200
Fax: 480-792-7277
Technical Support:
<http://www.microchip.com/support>
Web Address:
www.microchip.com

Atlanta
Duluth, GA
Tel: 678-957-9614
Fax: 678-957-1455

Austin, TX
Tel: 512-257-3370

Boston
Westborough, MA
Tel: 774-760-0087
Fax: 774-760-0088

Chicago
Itasca, IL
Tel: 630-285-0071
Fax: 630-285-0075

Cleveland
Independence, OH
Tel: 216-447-0464
Fax: 216-447-0643

Dallas
Addison, TX
Tel: 972-818-7423
Fax: 972-818-2924

Detroit
Novi, MI
Tel: 248-848-4000

Houston, TX
Tel: 281-894-5983

Indianapolis
Noblesville, IN
Tel: 317-773-8323
Fax: 317-773-5453

Los Angeles
Mission Viejo, CA
Tel: 949-462-9523
Fax: 949-462-9608

New York, NY
Tel: 631-435-6000

San Jose, CA
Tel: 408-735-9110

Canada - Toronto
Tel: 905-673-0699
Fax: 905-673-6509

ASIA/PACIFIC

Asia Pacific Office
Suites 3707-14, 37th Floor
Tower 6, The Gateway
Harbour City, Kowloon
Hong Kong
Tel: 852-2401-1200
Fax: 852-2401-3431

Australia - Sydney
Tel: 61-2-9868-6733
Fax: 61-2-9868-6755

China - Beijing
Tel: 86-10-8569-7000
Fax: 86-10-8528-2104

China - Chengdu
Tel: 86-28-8665-5511
Fax: 86-28-8665-7889

China - Chongqing
Tel: 86-23-8980-9588
Fax: 86-23-8980-9500

China - Hangzhou
Tel: 86-571-2819-3187
Fax: 86-571-2819-3189

China - Hong Kong SAR
Tel: 852-2943-5100
Fax: 852-2401-3431

China - Nanjing
Tel: 86-25-8473-2460
Fax: 86-25-8473-2470

China - Qingdao
Tel: 86-532-8502-7355
Fax: 86-532-8502-7205

China - Shanghai
Tel: 86-21-5407-5533
Fax: 86-21-5407-5066

China - Shenyang
Tel: 86-24-2334-2829
Fax: 86-24-2334-2393

China - Shenzhen
Tel: 86-755-8864-2200
Fax: 86-755-8203-1760

China - Wuhan
Tel: 86-27-5980-5300
Fax: 86-27-5980-5118

China - Xian
Tel: 86-29-8833-7252
Fax: 86-29-8833-7256

China - Xiamen
Tel: 86-592-2388138
Fax: 86-592-2388130

China - Zhuhai
Tel: 86-756-3210040
Fax: 86-756-3210049

ASIA/PACIFIC

India - Bangalore
Tel: 91-80-3090-4444
Fax: 91-80-3090-4123

India - New Delhi
Tel: 91-11-4160-8631
Fax: 91-11-4160-8632

India - Pune
Tel: 91-20-3019-1500

Japan - Osaka
Tel: 81-6-6152-7160
Fax: 81-6-6152-9310

Japan - Tokyo
Tel: 81-3-6880-3770
Fax: 81-3-6880-3771

Korea - Daegu
Tel: 82-53-744-4301
Fax: 82-53-744-4302

Korea - Seoul
Tel: 82-2-554-7200
Fax: 82-2-558-5932 or
82-2-558-5934

Malaysia - Kuala Lumpur
Tel: 60-3-6201-9857
Fax: 60-3-6201-9859

Malaysia - Penang
Tel: 60-4-227-8870
Fax: 60-4-227-4068

Philippines - Manila
Tel: 63-2-634-9065
Fax: 63-2-634-9069

Singapore
Tel: 65-6334-8870
Fax: 65-6334-8850

Taiwan - Hsin Chu
Tel: 886-3-5778-366
Fax: 886-3-5770-955

Taiwan - Kaohsiung
Tel: 886-7-213-7830

Taiwan - Taipei
Tel: 886-2-2508-8600
Fax: 886-2-2508-0102

Thailand - Bangkok
Tel: 66-2-694-1351
Fax: 66-2-694-1350

EUROPE

Austria - Wels
Tel: 43-7242-2244-39
Fax: 43-7242-2244-393

Denmark - Copenhagen
Tel: 45-4450-2828
Fax: 45-4485-2829

France - Paris
Tel: 33-1-69-53-63-20
Fax: 33-1-69-30-90-79

Germany - Dusseldorf
Tel: 49-2129-3766400

Germany - Munich
Tel: 49-89-627-144-0
Fax: 49-89-627-144-44

Germany - Pforzheim
Tel: 49-7231-424750

Italy - Milan
Tel: 39-0331-742611
Fax: 39-0331-466781

Italy - Venice
Tel: 39-049-7625286

Netherlands - Drunen
Tel: 31-416-690399
Fax: 31-416-690340

Poland - Warsaw
Tel: 48-22-3325737

Spain - Madrid
Tel: 34-91-708-08-90
Fax: 34-91-708-08-91

Sweden - Stockholm
Tel: 46-8-5090-4654

UK - Wokingham
Tel: 44-118-921-5800
Fax: 44-118-921-5820