



ON Semiconductor®

PN2907A / MMBT2907A / PZT2907A 60 V PNP General-Purpose Transistor

Features

- High DC Current Gain (h_{FE}) Range: 100 ~ 300
- High-Current Gain Bandwidth Product (f_T): 200 MHz (Minimum)
- Maximum Turn-On Time (t_{on}): 45 ns
- Maximum Turn-Off Time (t_{off}): 100 ns
- Ultra-Small Surface-Mount Package: SOT-223 (PZT2907A)

Applications

- General-Purpose Amplifier
- Switch

Description

The PN2907A, MMBT2907A, and PZT2907A are 60 V PNP bipolar transistors designed for use as a general-purpose amplifier or switch in applications that require up to 500 mA. Offered in an ultra-small surface-mount package (SOT-223), the PZT2907A is ideal for space-constrained systems. The NPN complementary types are the PN2222A, MMBT2222A, and PZT2222A; respectively.

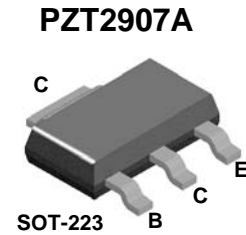
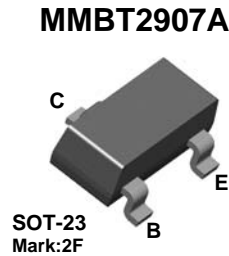

Ordering Information

Part Number	Top Mark	Package	Packing Method
PN2907ABU	2907A	TO-92 3L	Bulk
PN2907ATF	2907A	TO-92 3L	Tape and Reel
PN2907ATFR	2907A	TO-92 3L	Tape and Reel
PN2907ATA	2907A	TO-92 3L	Ammo
PN2907ATAR	2907A	TO-92 3L	Ammo
MMBT2907A	2F	SOT-23 3L	Tape and Reel
MMBT2907A-D87Z	2F	SOT-23 3L	Tape and Reel
PZT2907A	2907A	SOT-223 4L	Tape and Reel

PN2907A / MMBT2907A / PZT2907A — 60 V PNP General-Purpose Transistor

Absolute Maximum Ratings^{(1),(2)}

Stresses exceeding the absolute maximum ratings may damage the device. The device may not function or be operable above the recommended operating conditions and stressing the parts to these levels is not recommended. In addition, extended exposure to stresses above the recommended operating conditions may affect device reliability. The absolute maximum ratings are stress ratings only. Values are at $T_A = 25^\circ\text{C}$ unless otherwise noted.

Symbol	Parameter	Value	Unit
V_{CEO}	Collector-Emitter Voltage	-60	V
V_{CBO}	Collector-Base Voltage	-60	V
V_{EBO}	Emitter-Base Voltage	-5.0	V
I_C	Collector Current - Continuous	-800	mA
T_J, T_{STG}	Operating and Storage Junction Temperature Range	-55 to +150	$^\circ\text{C}$

Notes:

1. These ratings are based on a maximum junction temperature of 150°C .
2. These are steady-state limits. ON Semiconductor should be consulted on applications involving pulsed or low-duty cycle operations.

Thermal Characteristics

Values are at $T_A = 25^\circ\text{C}$ unless otherwise noted.

Symbol	Parameter	Max.			Unit
		PN2907A ⁽⁴⁾	MMBT2907A ⁽³⁾	PZT2907A ⁽⁴⁾	
P_D	Total Device Dissipation	625	350	1000	mW
	Derate Above 25°C	5.0	2.8	8.0	mW/ $^\circ\text{C}$
$R_{\theta JC}$	Thermal Resistance, Junction to Case	83.3			$^\circ\text{C}/\text{W}$
$R_{\theta JA}$	Thermal Resistance, Junction to Ambient	200	357	125	$^\circ\text{C}/\text{W}$

Notes:

3. Device is mounted on FR-4 PCB 1.6 inch X 1.6 inch X 0.06 inch.
4. PCB size: FR-4 76 x 114 x 1.57 mm³ (3.0 inch x 4.5 inch x 0.062 inch) with minimum land pattern size.

Electrical Characteristics

Values are at $T_A = 25^\circ\text{C}$ unless otherwise noted.

Symbol	Parameter	Conditions	Min.	Max.	Unit
Off Characteristics					
$V_{(BR)CEO}$	Collector-Emitter Breakdown Voltage ⁽⁵⁾	$I_C = -10\text{ mA}, I_B = 0$	-60		V
$V_{(BR)CBO}$	Collector-Base Breakdown Voltage	$I_C = -10\text{ }\mu\text{A}, I_E = 0$	-60		V
$V_{(BR)EBO}$	Emitter-Base Breakdown Voltage	$I_E = -10\text{ }\mu\text{A}, I_C = 0$	-5.0		V
I_{BL}	Base Cut-Off Current	$V_{CE} = -30\text{ V}, V_{EB} = -0.5\text{ V}$		-50	nA
I_{CEX}	Collector Cut-Off Current	$V_{CE} = -30\text{ V}, V_{EB} = -0.5\text{ V}$		-50	nA
I_{CBO}	Collector Cut-Off Current	$V_{CB} = -50\text{ V}, I_E = 0$		-0.02	μA
		$V_{CB} = -50\text{ V}, I_E = 0, T_A = 150^\circ\text{C}$		-20	
On Characteristics					
h_{FE}	DC Current Gain	$I_C = -0.1\text{ mA}, V_{CE} = -10\text{ V}$	75		
		$I_C = -1.0\text{ mA}, V_{CE} = -10\text{ V}$	100		
		$I_C = -10\text{ mA}, V_{CE} = -10\text{ V}$	100		
		$I_C = -150\text{ mA}, V_{CE} = -10\text{ V}^{(5)}$	100	300	
		$I_C = -500\text{ mA}, V_{CE} = -10\text{ V}^{(5)}$	50		
$V_{CE(sat)}$	Collector-Emitter Saturation Voltage ⁽⁵⁾	$I_C = -150\text{ mA}, I_B = -15\text{ mA}$		-0.4	V
		$I_C = -500\text{ mA}, I_B = -50\text{ mA}$		-1.6	
$V_{BE(sat)}$	Base-Emitter Saturation Voltage	$I_C = -150\text{ mA}, I_B = -15\text{ mA}^{(5)}$		-1.3	V
		$I_C = -500\text{ mA}, I_B = -50\text{ mA}$		-2.6	
Small Signal Characteristics					
f_T	Current Gain - Bandwidth Product	$I_C = -50\text{ mA}, V_{CE} = -20\text{ V},$ $f = 100\text{ MHz}$	200		MHz
C_{ob}	Output Capacitance	$V_{CB} = -10\text{ V}, I_E = 0,$ $f = 100\text{ kHz}$		8.0	pF
C_{ib}	Input Capacitance	$V_{EB} = -2.0\text{ V}, I_C = 0, f = 100\text{ kHz}$		30	pF
Switching Characteristics					
t_{on}	Turn-On Time	$V_{CC} = -30\text{ V}, I_C = -150\text{ mA},$ $I_{B1} = -15\text{ mA}$		45	ns
t_d	Delay Time			10	ns
t_r	Rise Time			40	ns
t_{off}	Turn-Off Time	$V_{CC} = -6.0\text{ V}, I_C = -150\text{ mA},$ $I_{B1} = I_{B2} = -15\text{ mA}$		100	ns
t_s	Storage Time			80	ns
t_f	Fall Time			30	ns

Notes:

5. Pulse test: pulse width $\leq 300\text{ }\mu\text{s}$, duty cycle $\leq 2.0\%$.

Typical Performance Characteristics

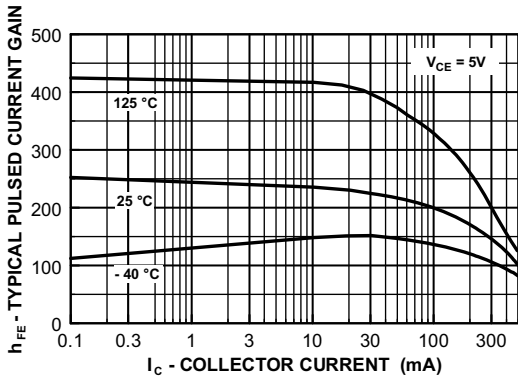

Figure 1. Typical Pulsed Current Gain vs. Collector Current

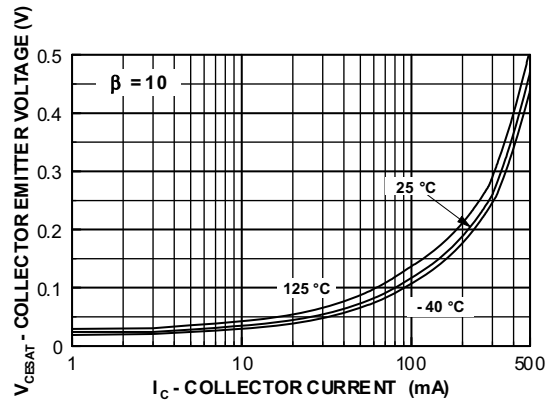

Figure 2. Collector-Emitter Saturation Voltage vs. Collector Current

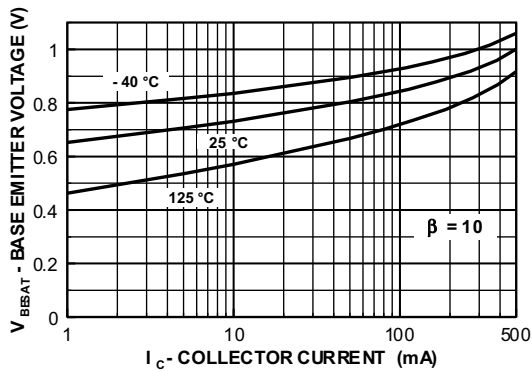

Figure 3. Base-Emitter Saturation Voltage vs. Collector Current

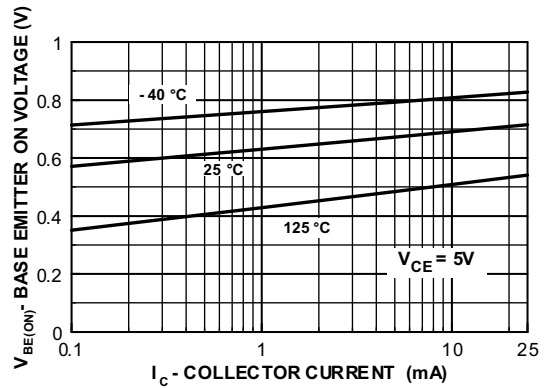

Figure 4. Base-Emitter On Voltage vs. Collector Current

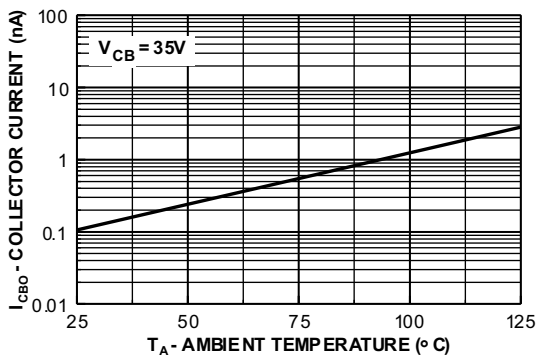

Figure 5. Collector Cut-Off Current vs. Ambient Temperature

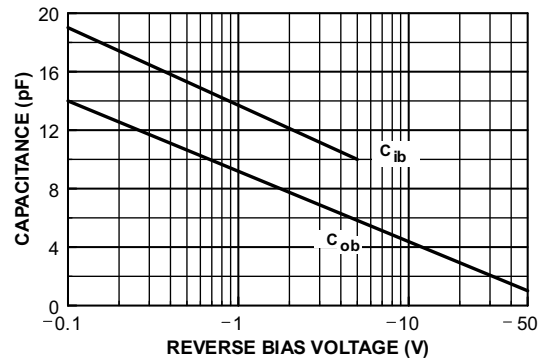

Figure 6. Input and Output Capacitance vs. Reverse Bias Voltage

Typical Performance Characteristics (Continued)

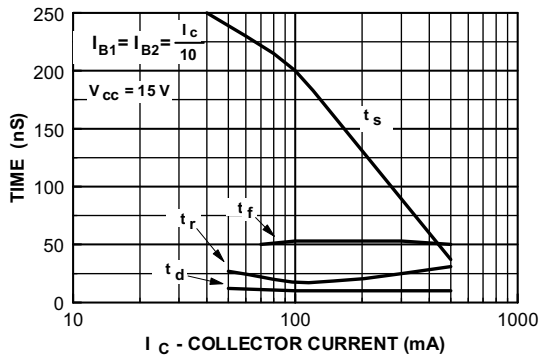

Figure 7. Switching Times vs. Collector Current

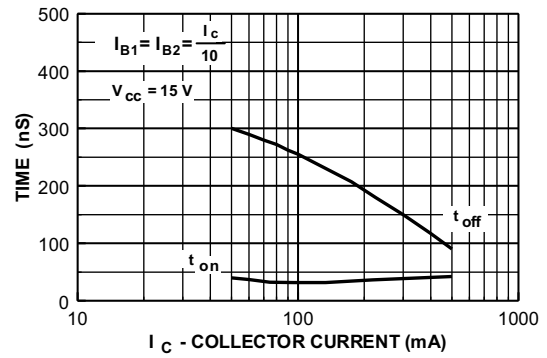

Figure 8. Turn-On and Turn-Off Times vs. Collector Current

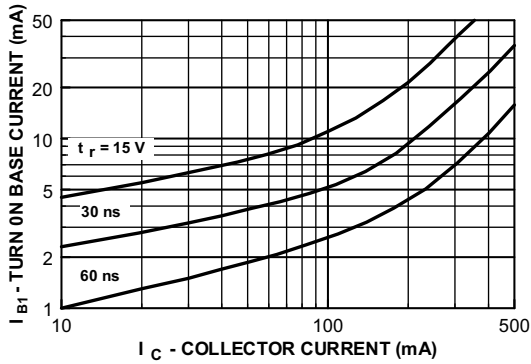

Figure 9. Rise Time vs. Collector and Turn-On Base Currents

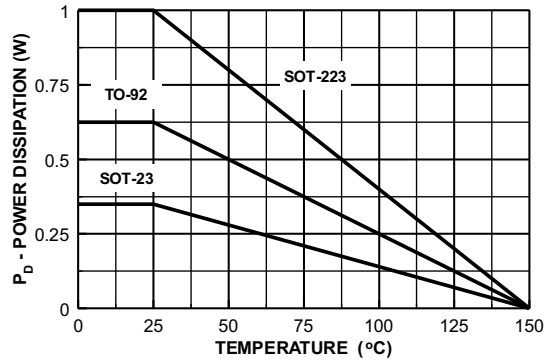

Figure 10. Power Dissipation vs. Ambient Temperature

Typical Performance Characteristics (f = 1.0 kHz)

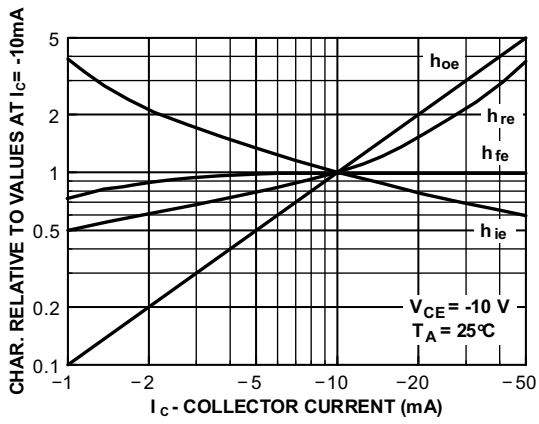

Figure 11. Common Emitter Characteristics

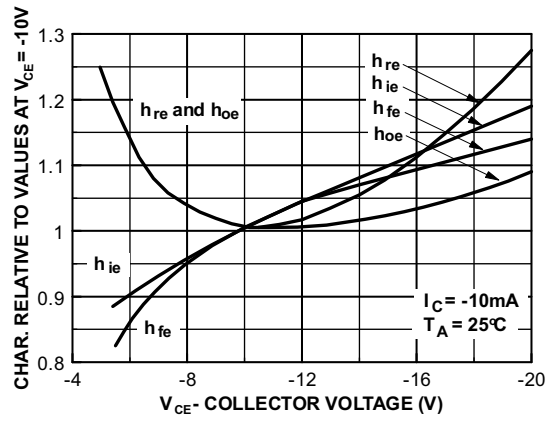

Figure 12. Common Emitter Characteristics

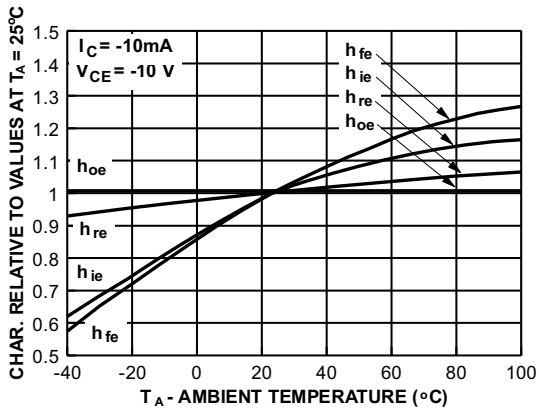
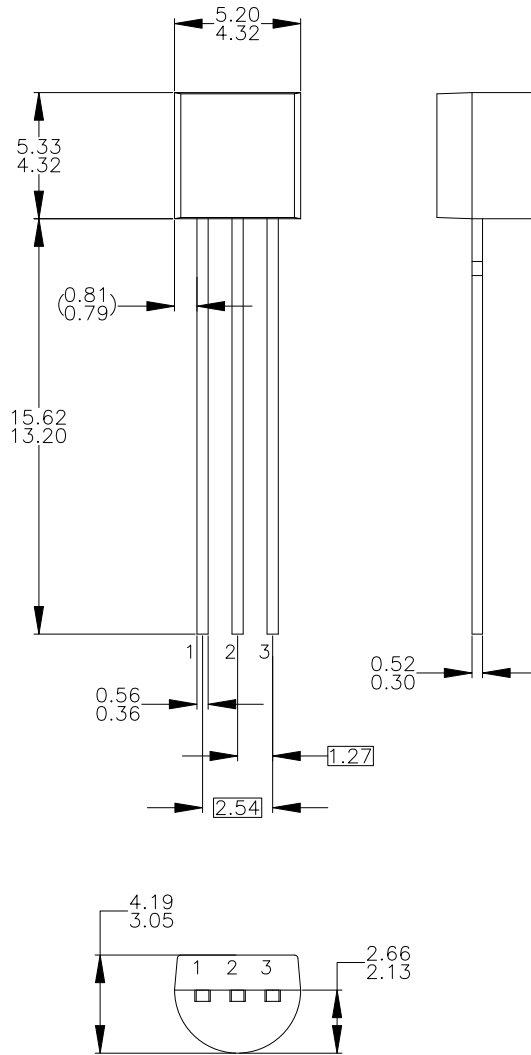

Figure 13. Common Emitter Characteristics

Physical Dimensions

TO-92 (Bulk)



NOTES: UNLESS OTHERWISE SPECIFIED

- A) DRAWING WITH REFERENCE TO JEDEC TO-92 RECOMMENDATIONS.
- B) ALL DIMENSIONS ARE IN MILLIMETERS.
- C) DRAWING CONFORMS TO ASME Y14.5M-1994.
- D) TO-92 (92,94,96,97,98) PIN CONFIGURATION:

PIN	92	94	96	97	98
P	F	M	P	F	M
1	E	S	S	E	S
2	B	D	G	C	G
3	C	G	D	B	D

LEGEND:

- P - BIPOLAR
- F - JFET
- M - DMOS
- E - EMITTER
- B - BASE
- C - COLLECTOR
- D - DRAIN
- S - SOURCE
- G - GATE

- E) FOR PACKAGE 92, 94, 96, 97 AND 98: PIN CONFIGURATION DRAIN "D" AND SOURCE "S" ARE INTERCHANGEABLE AT JFET "F" OPTION.
- F) DRAWING FILENAME: MKT-ZA03DREV3.

Figure 14. 3-LEAD, TO92, JEDEC TO-92 COMPLIANT STRAIGHT LEAD CONFIGURATION (OLD TO92AM3) (ACTIVE)

Package drawings are provided as a service to customers considering ON Semiconductor components. Drawings may change in any manner without notice. Please note the revision and/or date on the drawing and contact a ON Semiconductor representative to verify or obtain the most recent revision. Package specifications do not expand the terms of ON Semiconductor's worldwide terms and conditions, specifically the warranty therein, which covers ON Semiconductor products.

Physical Dimensions (Continued)

TO-92 (Tape and Reel, Ammo)

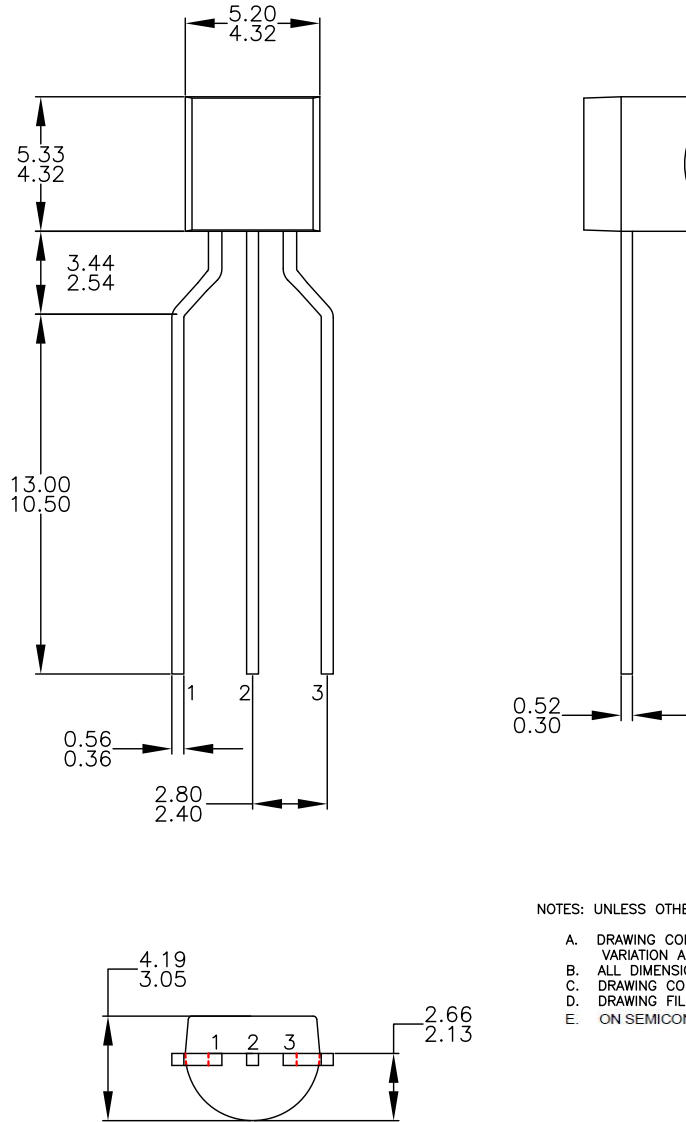

NOTES: UNLESS OTHERWISE SPECIFIED

- A. DRAWING CONFORMS TO JEDEC MS-013, VARIATION AC.
- B. ALL DIMENSIONS ARE IN MILLIMETERS.
- C. DRAWING CONFORMS TO ASME Y14.5M-2009.
- D. DRAWING FILENAME: MKT-ZA03FREV3.
- E. ON SEMICONDUCTOR

Figure 15. 3-LEAD, TO92, MOLDED 0.200 IN LINE SPACING LEAD FORM (J61Z OPTION) (ACTIVE)

Package drawings are provided as a service to customers considering ON Semiconductor components. Drawings may change in any manner without notice. Please note the revision and/or date on the drawing and contact a ON Semiconductor representative to verify or obtain the most recent revision. Package specifications do not expand the terms of ON Semiconductor's worldwide terms and conditions, specifically the warranty therein, which covers ON Semiconductor products.

Physical Dimensions (Continued)

SOT-23

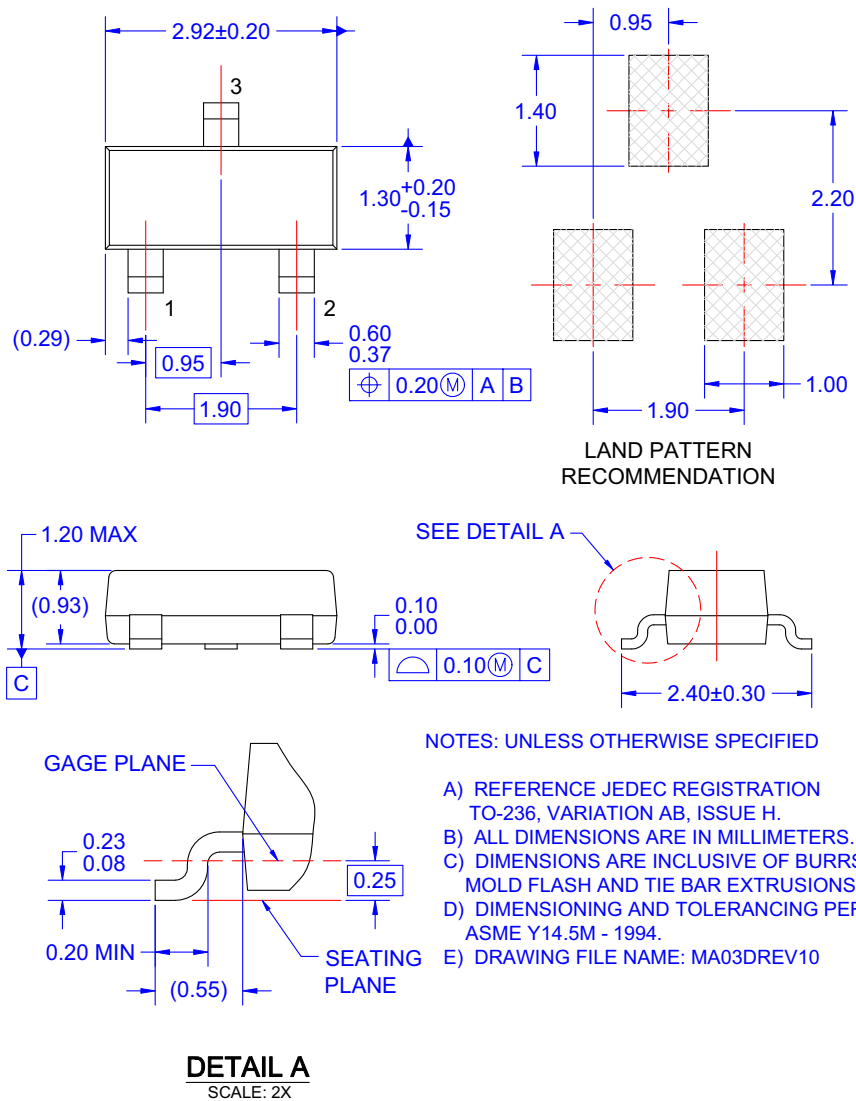

Figure 16. 3-LEAD, SOT23, JEDEC TO-236, LOW PROFILE (ACTIVE)

Package drawings are provided as a service to customers considering ON Semiconductor components. Drawings may change in any manner without notice. Please note the revision and/or date on the drawing and contact a ON Semiconductor representative to verify or obtain the most recent revision. Package specifications do not expand the terms of ON Semiconductor's worldwide terms and conditions, specifically the warranty therein, which covers ON Semiconductor products.

Physical Dimensions (Continued)

SOT-223

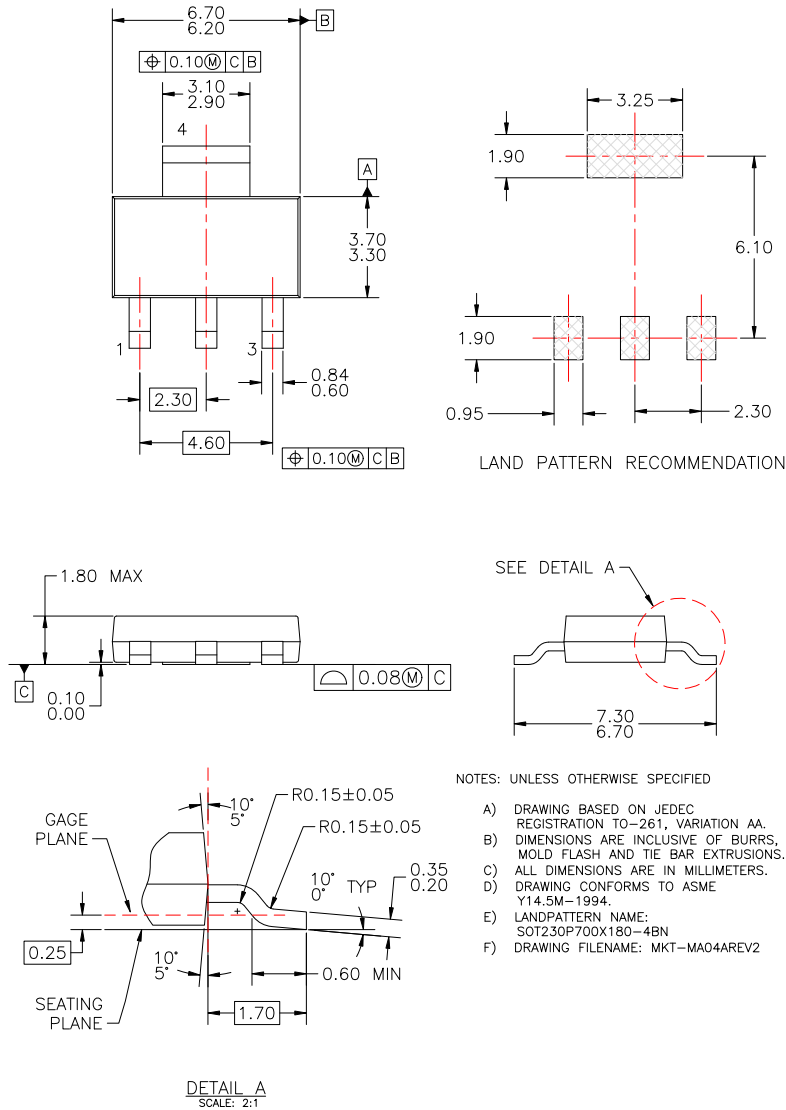

Figure 17. MOLDED PACKAGING, SOT-223, 4-LEAD (ACTIVE)

Package drawings are provided as a service to customers considering ON Semiconductor components. Drawings may change in any manner without notice. Please note the revision and/or date on the drawing and contact a ON Semiconductor representative to verify or obtain the most recent revision. Package specifications do not expand the terms of ON Semiconductor's worldwide terms and conditions, specifically the warranty therein, which covers ON Semiconductor products.

ON Semiconductor and  are trademarks of Semiconductor Components Industries, LLC dba ON Semiconductor or its subsidiaries in the United States and/or other countries. ON Semiconductor owns the rights to a number of patents, trademarks, copyrights, trade secrets, and other intellectual property. A listing of ON Semiconductor's product/patent coverage may be accessed at www.onsemi.com/site/pdf/Patent-Marking.pdf. ON Semiconductor reserves the right to make changes without further notice to any products herein. ON Semiconductor makes no warranty, representation or guarantee regarding the suitability of its products for any particular purpose, nor does ON Semiconductor assume any liability arising out of the application or use of any product or circuit, and specifically disclaims any and all liability, including without limitation special, consequential or incidental damages. Buyer is responsible for its products and applications using ON Semiconductor products, including compliance with all laws, regulations and safety requirements or standards, regardless of any support or applications information provided by ON Semiconductor. "Typical" parameters which may be provided in ON Semiconductor data sheets and/or specifications can and do vary in different applications and actual performance may vary over time. All operating parameters, including "Typicals" must be validated for each customer application by customer's technical experts. ON Semiconductor does not convey any license under its patent rights nor the rights of others. ON Semiconductor products are not designed, intended, or authorized for use as a critical component in life support systems or any FDA Class 3 medical devices or medical devices with a same or similar classification in a foreign jurisdiction or any devices intended for implantation in the human body. Should Buyer purchase or use ON Semiconductor products for any such unintended or unauthorized application, Buyer shall indemnify and hold ON Semiconductor and its officers, employees, subsidiaries, affiliates, and distributors harmless against all claims, costs, damages, and expenses, and reasonable attorney fees arising out of, directly or indirectly, any claim of personal injury or death associated with such unintended or unauthorized use, even if such claim alleges that ON Semiconductor was negligent regarding the design or manufacture of the part. ON Semiconductor is an Equal Opportunity/Affirmative Action Employer. This literature is subject to all applicable copyright laws and is not for resale in any manner.

PUBLICATION ORDERING INFORMATION

LITERATURE FULFILLMENT:

Literature Distribution Center for ON Semiconductor
19521 E. 32nd Pkwy, Aurora, Colorado 80011 USA
Phone: 303-675-2175 or 800-344-3860 Toll Free USA/Canada
Fax: 303-675-2176 or 800-344-3867 Toll Free USA/Canada
Email: orderlit@onsemi.com

N. American Technical Support: 800-282-9855 Toll Free
USA/Canada
Europe, Middle East and Africa Technical Support:
Phone: 421 33 790 2910
Japan Customer Focus Center
Phone: 81-3-5817-1050

ON Semiconductor Website: www.onsemi.com
Order Literature: <http://www.onsemi.com/orderlit>
For additional information, please contact your local
Sales Representative