

ASBV.../LED

4 + PE

Aktor-/Sensor-Verteiler mit LED-Betriebs- und Funktions-anzeige, 4-, 6- und 8-fach, kombinierte FIXCON-/M12-Buchse, 5-polig, 2 Signale pro Buchse, Erdanschluss, fest angeschlossenes Kabel

Actuator/sensor distribution box with LED operation and function indicators, 4, 6 and 8 ports, combined FIXCON/M12 socket, 5 poles, 2 signals per socket, earth connection, integrated control cable

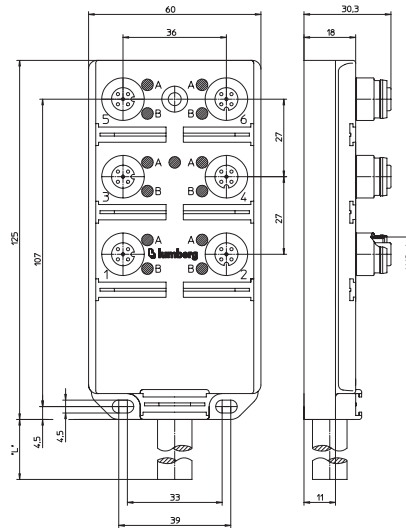
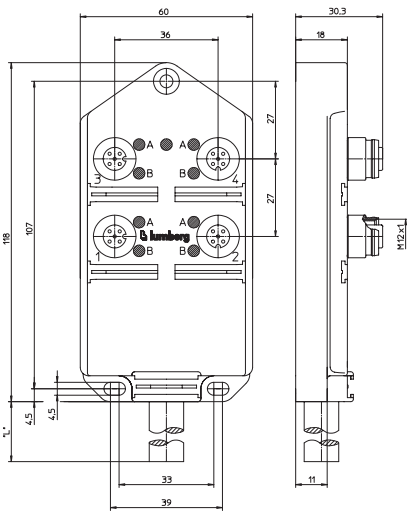
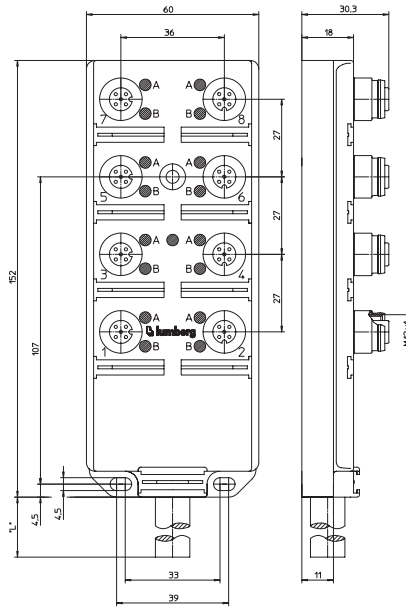

Pinbelegung / Schaltbild
Pin assignment / wiring diagram

4-fach
4 ports

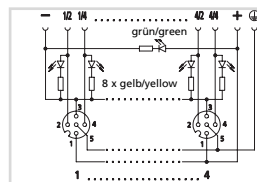

- | | |
|------------------------------|------|
| 1 = braun / brown | (+) |
| 2 = grau/rosa / grey/pink | (1) |
| rot/blau / red/blue | (2) |
| weiß/grün / white/green | (3) |
| braun/grün / brown/green | (4) |
| 3 = blau / blue | (-) |
| 4 = weiß / white | (1) |
| grün / green | (2) |
| gelb / yellow | (3) |
| grau / grey | (4) |
| 5 = grün/gelb / green/yellow | (PE) |

6-fach
6 ports

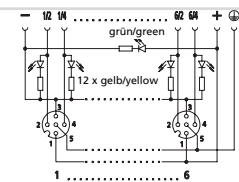

- | | |
|------------------------------|------|
| 1 = braun / brown | (+) |
| 2 = grau/rosa / grey/pink | (1) |
| rot/blau / red/blue | (2) |
| weiß/grün / white/green | (3) |
| braun/grün / brown/green | (4) |
| weiß/gelb / white/yellow | (5) |
| gelb/braun / yellow/brown | (6) |
| 3 = blau / blue | (-) |
| 4 = weiß / white | (1) |
| grün / green | (2) |
| gelb / yellow | (3) |
| grau / grey | (4) |
| rosa / pink | (5) |
| rot / red | (6) |
| 5 = grün/gelb / green/yellow | (PE) |

8-fach
8 ports

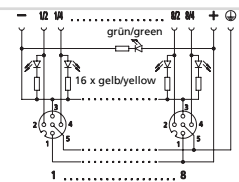













- | | |
|------------------------------|------|
| 1 = braun / brown | (+) |
| 2 = grau/rosa / grey/pink | (1) |
| rot/blau / red/blue | (2) |
| weiß/grün / white/green | (3) |
| braun/grün / brown/green | (4) |
| weiß/gelb / white/yellow | (5) |
| gelb/braun / yellow/brown | (6) |
| weiß/grau / white/grey | (7) |
| grau/braun / grey/brown | (8) |
| 3 = blau / blue | (-) |
| 4 = weiß / white | (1) |
| grün / green | (2) |
| gelb / yellow | (3) |
| grau / grey | (4) |
| rosa / pink | (5) |
| rot / red | (6) |
| schwarz / black | (7) |
| violett / violet | (8) |
| 5 = grün/gelb / green/yellow | (PE) |



Technische Daten	
Umgebungstemperatur	-15°C / +80°C
Werkstoffe	
Gehäuse / Griffkörper	TPU, selbstverlöschend
Kontaktträger	PA GF, selbstverlöschend
Kontakt	CuZn, unternickelt und 0,8 µm vergoldet
Gewindebuchse / Rändelschraube/-mutter / Sechskantschraube/-mutter / Hülse	CuZn, vernickelt
O-Ring	FKM
Mechanische Daten	
Schutzart	IP 67 Nur im verriegelten oder verschraubten Zustand mit den dazugehörigen Gegenstücken oder Schutzkappen.
Elektrische Daten	
Durchgangswiderstand	≤ 5 mΩ
Nennstrom bei 40°C	4 A pro Steckplatz / 12 A max. gesamt
Nennspannung	10–30 V DC
Bemessungsspannung	32 V
Isolationswiderstand	> 10 ⁹ Ω
Verschmutzungsgrad	3
Zubehör (inkl.)	
ZVK	2 Schutzkappen für nicht belegte Kupplungsgehäuse
ZBS	10 Beschriftungsschilder

Technical data	
Operating temperature range	-15°C / +80°C
Materials	
Housing / Molded body	TPU, self-extinguishing
Insert	PA GF, self-extinguishing
Contact	CuZn, pre-nickelated and 0.8 microns gold-plated
Receptacle shell / knurled screw/nut / hexagon screw/nut / sleeve	CuZn, nickel-plated
O-ring	FKM
Mechanical data	
Degree of protection	IP 67 Only in locked position with its proper counterparts or dust covers.
Electrical data	
Contact resistance	≤ 5 mΩ
Nominal current at 40°C	4 A per outlet / 12 A max. total
Nominal voltage	10–30 V DC
Rated voltage	32 V
Insulation resistance	> 10 ⁹ Ω
Pollution degree	3
Accessories (incl.)	
ZVK	2 dust covers for unused sockets
ZBS	10 attachable labels

Bestellbezeichnung Designation	Ausführung Version	Mantel Outer jacket	
ASBV 4/LED 5-256/... M	4-fach / 4 ports	PUR halogenfrei / halogen free	   
ASBV 6/LED 5-332/... M	6-fach / 6 ports	PUR halogenfrei / halogen free	   
ASBV 8/LED 5-242/... M	8-fach / 8 ports	PUR halogenfrei / halogen free	   
Standardlängen: 5 M / 10 M / 15 M Andere Kabellängen oder Leitungsaufbauten auf Anfrage.		Standard lengths: 5 M / 10 M / 15 M Other cable lengths or cable specifications on request.	