

Illumec™ 4F

Illuminated switches • slip-on cap retention system • integrated chip-LEDs



DISTINCTIVE FEATURES

10 x 10 mm ; h=10.4 mm

Illumination with integrated chip-LEDs

Single or bi-color illumination

Momentary NO

Simple slip-on cap retention system



ENVIRONMENTAL SPECIFICATIONS

- Switch sealing : IP67 according to IEC 60529
- Working and storage temperature : -30 °C/+85 °C
- Soldering :
 - through-hole : IEC 68-2-20 8
 - surface mount : JEDEC J-STD-020E



ELECTRICAL SPECIFICATIONS

- Recommended load :
 - Gold contacts : 0.5 μ -50 mA 24 VDC
 - Silver contacts : 0.5-50 mA 24 VDC
- Contact resistance : <30 m Ω - typically 10 m Ω
- Insulation resistance : >10 M Ω
- Contact bounce : <2 mS - typically 0.5 mS



MECHANICAL SPECIFICATIONS

- Standard actuation force : 3.5 N
- Max. actuation force : 100 N for 10 sec
- Travel : 1 mm
- Lifetime : >10,000,000 cycles

The company reserves the right to change specifications without notice.

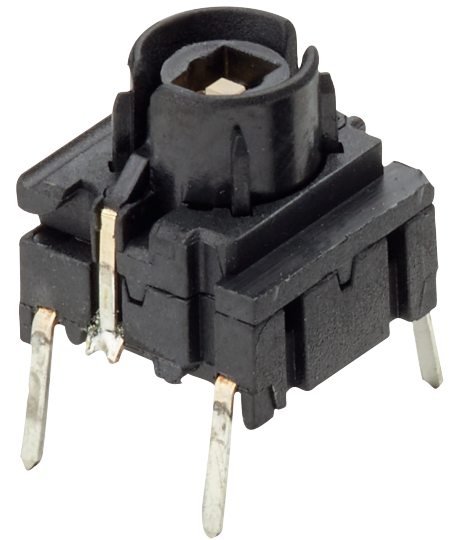

MATERIALS

- Housing : PPS UL94V0
- Actuator : PPS UL94V0
- Sealing : Silicone rubber
- Contacts spring : Stainless steel
 - Silver : +3 μ Ag
 - Gold : +1 μ Au
- Fixed contacts :
 - Silver : SnCu + 2 μ Ni + 3 μ Ag
 - Gold : SnCu + 2 μ Ni + 1 μ Au
- Terminals : SnCu + 2 μ Ni + 3 μ Sn100

All tolerance if not otherwise specified \pm 0.2mm.

Illumec™ 4F

Illuminated switches • slip-on cap retention system • integrated chip-LEDs

4FSH9XX



- SMD
- NO
- Single or bi-color LEDs

4FTH9XX



- TH
- NO
- Single or bi-color LEDs

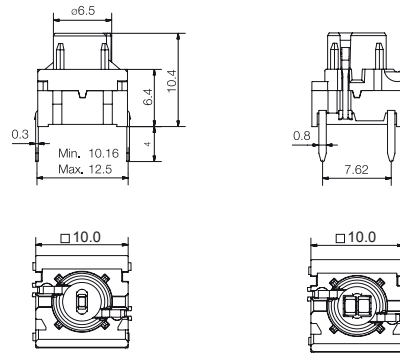
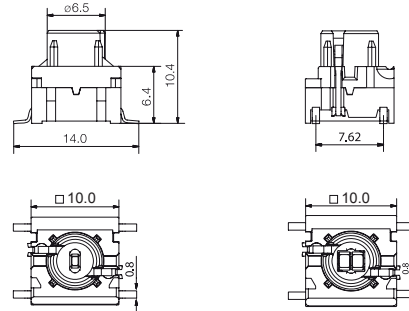

All tolerances unless otherwise noted : ±0.2 mm

PCB LAYOUT & CIRCUIT DIAGRAM

SINGLE LED

BI-COLOR - 2 LEDs

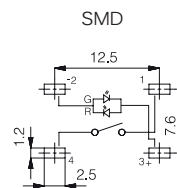
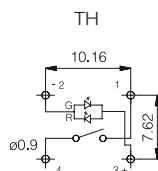
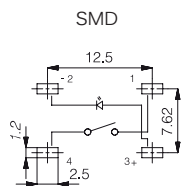
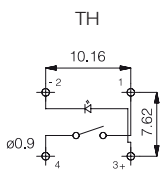

Illuminated switches • slip-on cap retention system • integrated chip-LEDs



BUILD YOUR PART NUMBER

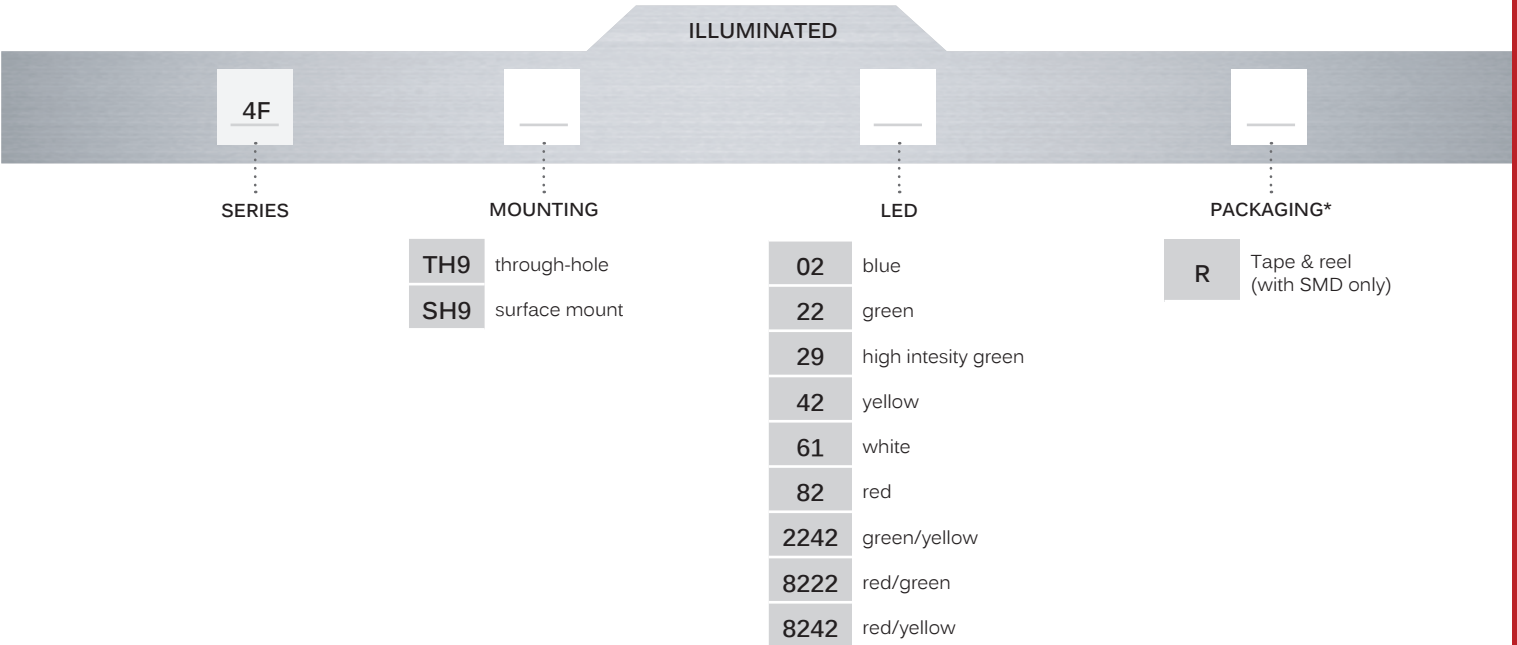

*optional



ABOUT THIS SERIES

- Notice** : Refer to www.apem.com for further information.
- Accessories** : See the website for 4F cap and bezel options

Illumec™ 4F

Illuminated switches • slip-on cap retention system • integrated chip-LEDs



TAPE & REEL

Tape and reel is available for the parts listed and has the following specifications

- Reel diameter: Ø330 mm
- Tape width: 24 mm
- Pitch: see list
- Tape and reel material: antistatic or better
- Quantity per reel: see list

PART NO.	ORDERING CODE	PITCH	QUANTITY PER REEL
4FSH902	4FSH902R	20	250
4FSH922	4FSH922R	20	250
4FSH942	4FSH942R	20	250
4FSH961	4FSH961R	20	250
4FSH982	4FSH982R	20	250
4FSH92242	4FSH92242R	20	250
4FSH98222	4FSH98222R	20	250
4FSH98242	4FSH98242R	20	250



OPERATING FORCE

3.5 N

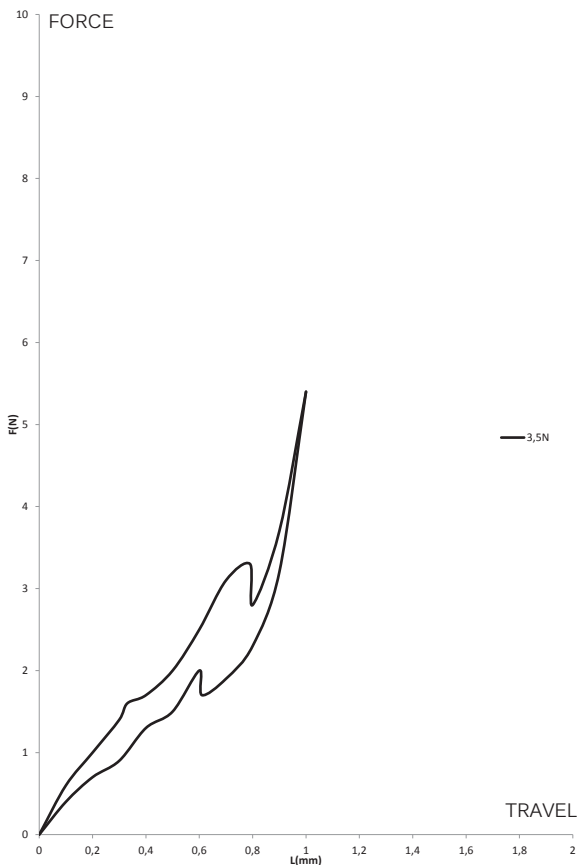

Illuminated switches • slip-on cap retention system • integrated chip-LEDs



MOUNTING

SPACE REQUIREMENT - MATRIX MOUNTING

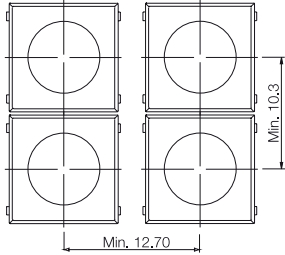

Through-hole (TH)

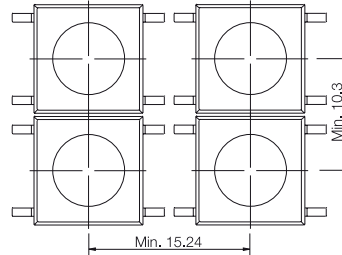

Surface mount (SMD)

ILLUMEC™ SPACING EXAMPLES

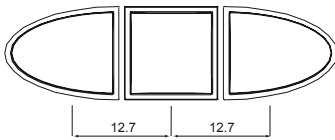

1V+1T+1V

SPACE REQUIREMENT - SWITCH/CAP

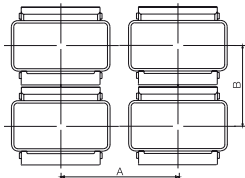

Switch spacing

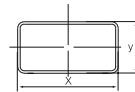

Cap dimensions

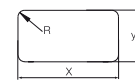

Panel cut-out

CAP SERIES	RECOMMENDED MIN.SWITCH SPACING AxB	NOMINAL CAP DIMENSION WxH	RECOMMENDED MIN. PANEL CUT-CUT
1D/1E/1F	12.7x11.3	Ø9.6	Ø10.0
1GA	12.7x11.3	Ø11.0	Ø11.4
1GC	15.3x15.3	Ø15.0	Ø15.4
1K/1KB/1KC	14.6x14.6	14.3x14.3	14.7x14.7
1N	13.6x11.3	Ø9.8/ □4.9	Ø10.2/□5.1
1P/ 1Q/1R	12.8x10.3	6.5x12.5	7.0x13.0, R max. 1.0
1S	12.7x10.3	Ø6.5	Ø7.0
1T	12.7x12.3	10.6x10.6	11.0x11.0
1U	12.7x12.3	Ø10.6	Ø11.0
1V	15.95x12.1	10.6x13.25	11.0x13.65
1WA	14.2x10.3	12.5x6.5	12.9x6.9
1WD	16.9x10.3	15.2x8.0	15.6x8.4
1X	12.7x10.3	9.4x7.4	9.8x7.9
1ZC	14.6x14.6	Ø14.3	Ø14.7

*I=20mA, **Pulse width 1ms Duty cycle 1:5, ***/I=50mA, ****Luminous Flux mlm

Illumec™ 4F

Illuminated switches • slip-on cap retention system • integrated chip-LEDs



LED COMPONENT SPECIFICATIONS

LED COMPONENT SPECIFICATIONS							
Color		Blue	Green	Yellow	White	Red	High Intensity Green
Color Codes		02	22	42	61	82	29
ABSOLUTE MAXIMUM RATINGS (Ta=25°C)							
Power	mW	75	75	60	46.5	65	102.5
Current forward	mA	20	30	25	15	25	25
Forward peak current	mA	100	80	60	100	100	150
Voltage reverse	V	5	5	5	5	12	5
Operating temperature	°C	-40/+85	-55/+85	-40/+85	-40/+85	-30/+85	-40/+85
Storage temperature	°C	-40/+90	-55/+85	-40/+90	-40/+85	-40/+85	-40/+85
Soldering temperature	°C	245 for max. 10 sec					
ELECTRICAL-OPTICAL CHARACTERISTICS (Ta=25°C)							
Voltage forward	Typ. V	2.7	2	1.75**	2.85	2	3.3
	Max. V	3.7	2.4	2.35	3.1	2.5	4.1
Current reverse (VR=5V)	Max. µA	50	100	10	10	100	50
Wave length	nm	468	571	591	NA	633	525
Spread	Δnm	25	NA	15	NA	16	30
Spread angle	degree	120	130	120	150	160	60
Luminous Intensity	Min. mcd	45	18	28.5	56	28	500
	Typ. mcd	112*	35	72*	max 450*	max 180*	1000
Optical intensity	Lm/w	NA	NA	NA	36	7	NA

*/F=20mA, **Pulse width 1ms Duty cycle 1:5, ***/F=50mA, ****Luminous Flux lmm

Illuminated switches • slip-on cap retention system • integrated chip-LEDs



USAGE GUIDELINES

HOW TO GET THE BEST RESULTS WITH MEC SWITCHES ?

These guidelines are offered to users of MEC Switches as an aid to ensure successful and reliable switch operation. Please see the technical specifications for details on operating and storage temperatures and soldering guidelines to make sure you select the best switch for your application. When reflow soldering is taking place, MEC strongly recommend that the temperature profile is analyzed and compared with the temperature rating of the switch. It is also important to monitor the accumulated heat buildup from both the pre-heat zones and the solder zone.

Most standard accessories for illumec™ 4 series switches are made from ABS plastic with a maximum operating temperature of 65 °C. It is strongly recommended that accessories are mounted after soldering of the switch.

For accessories made from other plastic materials please see multimec™ 3 series cap and bezel technical specifications.

LEDs have their own temperature specifications. When fitted in a 4F switch the LED will determine the max. operating temperature, i.e. 4FSH982 has an upper temperature limit of 85 °C!

MOUNTING AND DISMOUNTING

If switches are to be mounted in rows it is essential that the recommendations regarding spacing are followed. PC board thickness should be 1.4 ±0.2 mm and terminal hole diameter should be 0.9 mm.

All illumec™ caps and bezels are easily slid onto the switch modules and can be changed at a later time.

A mounting tool is available for through hole illumec™ 4F series switches.

SOLDERING AND CLEANING ILLUMEC™ 4F SERIES

Illumec™ 4F series switches are sealed to IP67 specifications to prevent solder flux and aqueous based cleaning solutions from entering the switch and contaminating the contacts. The switches can be placed on the PC board with other components and reflow soldered. Please note that the integrated LEDs are not sealed.

SOLDERING - THROUGH HOLE VERSIONS

Hand soldering: max. 350 °C for max. 3 sec

Wave soldering: heat built up in the switch during pre-heating and soldering must not exceed the maximum operating temperature of the switch. Peak temperature must not exceed 260 °C, and soldering time is max 10 sec. (IEC 600 68-2-20 8)

SOLDERING - SURFACE MOUNT VERSIONS

For all methods - infrared, convection and vapor phase. The upper limit 240 °C/40 sec must be observed. The soldering temperature profile must have moderate temperature gradients. (JEDEC J-STD-020E)

ROHS COMPLIANCE

As of 1 July 2006 MEC has completed the conversion to RoHS compliance. For more info please see our homepage www.apem.com

TEMPERATURE LIMITS

Switch	160 °C
LEDs	85/90 °C
Accessories	65/85/160 °C

PACKAGING

Illumec™ 4F series switches are packed in rigid tubes of 50 pieces each.

A box contains 1.000 pcs.

The surface mount versions of Illumec™ 4F series switches can also be delivered on tape/reel. Each reel contains 250 pcs.