

**NOTES:**

- 適合ターミナルシリーズ:503657シリーズ  
APPLICABLE TERMINAL:503657 SERIES
- 嵌合相手:503660シリーズ  
MATE WITH:503660 SERIES
- 偶数極に適用。  
APPLY FOR EVEN CIRCUIT.
- トレードマーク:MXLにて表示。  
キャビティー番号:1桁から2桁の数字にて表示。 全型番号:アルファベット1文字にて表示。  
TRADE MARK IS FORMED BY MXL.  
AND BY 1 - 2 DIGIT NUMBER (TO CAVITY No.)  
AND BY 1 LETTER OF ALPHABET (TO MOLD No.)
- 本製品のプラスチック部に黒点等が確認される場合や、色合いが異なる場合が御座いますが、製品性能に影響は御座いません。  
THERE IS NO INFLUENCE IN THE PRODUCT PERFORMANCE THOUGH THE BLACK SPOT ETC.  
MIGHT BE CONFIRMED TO THE PLASTIC PART OF THIS PRODUCT AND  
THE SHADE MIGHT BE DIFFERENT.
- 製品の取扱いについては、コネクタ取扱説明書(AS-503658-001)を参照願います。  
PLEASE REFER TO INSTRUCTION MANUAL(AS-503658-001).
- ELV及びRoHS適合品  
ELV AND RoHS COMPLIANT.

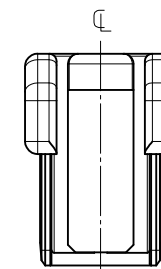
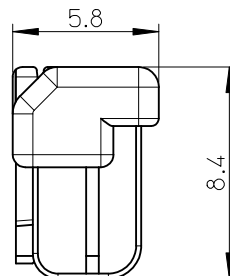
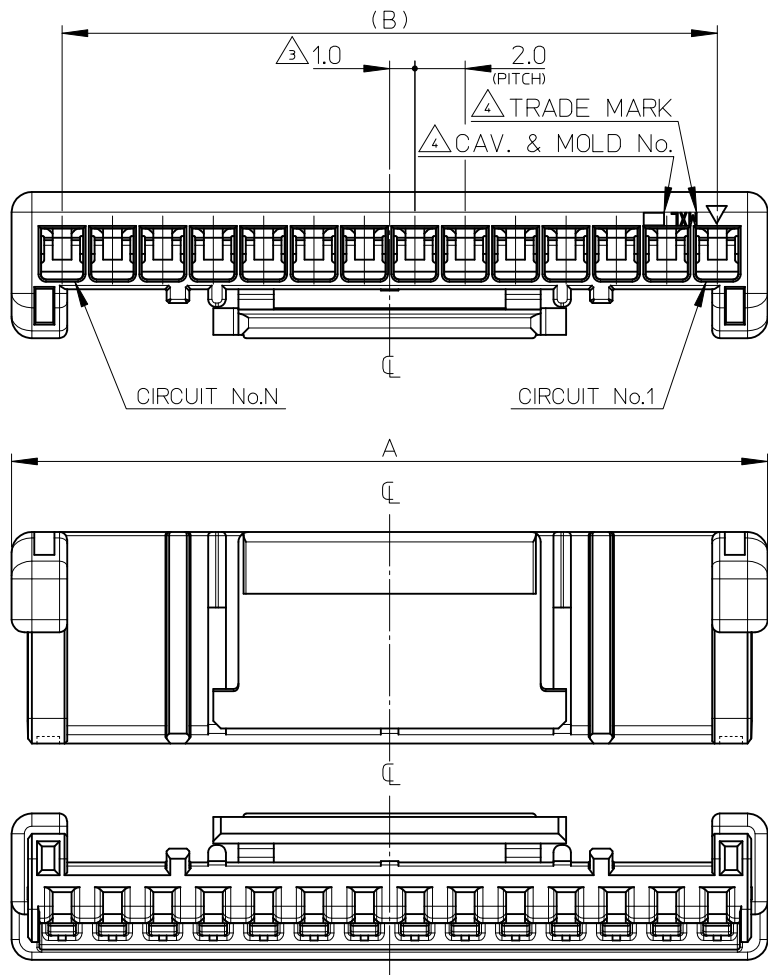

2,3極形状(1ロック)  
FIGURE OF 2,3 CIRCUIT (1 LOCK)

28	32	503658	-1500	503658-**00	15
26	30	↑	-1400		14
22	26		-1200		12
18	22		-1000		10
14	18		-0800		8
10	14		-0600		6
8	12		-0500		5
6	10	503658	-0400		4
B	A	ORDER NO.		CONNECTOR SERIES NO.	CIRCUIT

部品 PART	材質 MATERIAL
ハウジング HOUSING	ポリエステル(PBT) UL94V-0 POLYESTER UL94V-0 色:ナチュラル(白) COLOR: NATURAL(WHITE)

REVISED EC NO.: J2011-0238 DRWN:SKUROSE 2010/08/16 CHKD:KASAKAWA 2010/08/16 APPR:NUKITA 2010/08/19	DESCRIPTION REV	GENERAL TOLERANCES (UNLESS SPECIFIED)		DIMENSION STYLE MM ONLY	SCALE 5:1	DESIGN UNITS METRIC	THIRD ANGLE PROJECTION	
		10 UNDER	±0.2	DRAWN BY SSAT002	DATE 2010/08/06	TITLE 2.0 W/B CONN. SINGLE REC. CRIMP HS'G		
		10 OVER 30 UNDER	±0.25	CHECKED BY KASAKAWA	DATE 2010/08/16	APPROVED BY NUKITA 2010/08/16		
		30 OVER	±0.3	MATERIAL NO. SEE CHART		DOCUMENT NO. SD-503658-001		
ANGULAR ±1 °		DRAFT WHERE APPLICABLE MUST REMAIN WITHIN DIMENSIONS		SIZE A3	THIS DRAWING CONTAINS INFORMATION THAT IS PROPRIETARY TO MOLEX INCORPORATED AND SHOULD NOT BE USED WITHOUT WRITTEN PERMISSION			



NOTES:

1. 嵌合相手: 503658 シリーズ  
MATE WITH: 503658 SERIES.
- △<sub>2</sub> 偶数極に適用。  
APPLY FOR EVEN CIRCUIT.
- △<sub>3</sub> キンクは両端2ピンに付加。  
KINK ATTACHED TO THE POSITION OF 2PINS TO BOTH OUTSIDE ENDS.
- △<sub>4</sub> 2極以外のキンク形状は両サイドが①、それ以外のキンク形状は全て②形状とする。  
3極のキンク形状は両サイドに①、2ピン目に②形状を付加する。  
MORE THAN 2 CIRCUIT : PINS AT BOTH ENDS ARE KINK FORMED TO ①  
THE OTHER PINS ARE KINK FORMED TO ②  
3 CIRCUIT : PINS AT BOTH ENDS ARE KINK FORMED TO ①  
THE OTHER PINS ARE KINK FORMED TO ②
- △<sub>5</sub> トレードマーク: MXLにて表示。  
キャビティ番号: 1桁から2桁の数字にて表示。 金型番号: アルファベット1文字にて表示。  
TRADE MARK IS FORMED BY MXL.  
AND BY 1 - 2 DIGIT NUMBER (TO CAVITY No.)  
AND BY 1 LETTER OF ALPHABET (TO MOLD No.)
6. 本製品のプラスチック部に黒点等が確認される場合や、色合いが異なる場合が御座いますが、製品性能に影響は御座いません。  
THERE IS NO INFLUENCE IN THE PRODUCT PERFORMANCE THOUGH THE BLACK SPOT ETC.  
MIGHT BE CONFIRMED TO THE PLASTIC PART OF THIS PRODUCT AND  
THE SHADE MIGHT BE DIFFERENT.
7. 製品の取り扱いについては、コネクタ取扱説明書(AS-503658-001)を参照願います。  
PLEASE REFER TO INSTRUCTION MANUAL(AS-503658-001)
8. ELV及びRoHS適合品  
ELV AND RoHS COMPLIANT

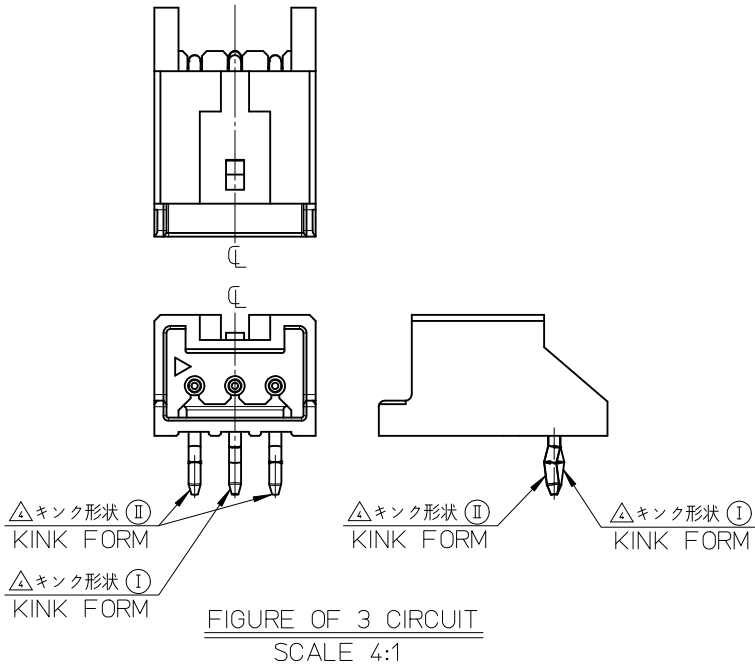
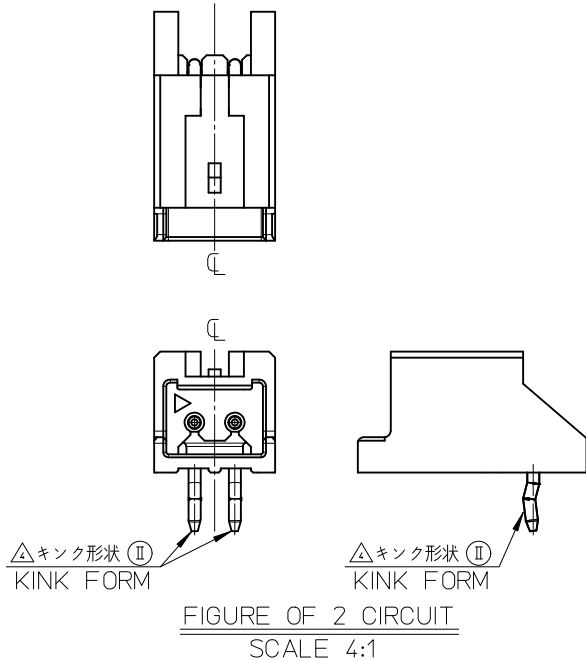

REVISED	EC NO.: J2012-0117	2011/07/25	GENERAL TOLERANCES (UNLESS SPECIFIED)		DIMENSION STYLE MM ONLY		SCALE 4:1	DESIGN UNITS METRIC	THIRD ANGLE PROJECTION	
	DRWN:SSAT002	2011/07/25	10 UNDER	±0.2	DRAWN BY SSAT002	DATE 2010/08/06	TITLE	2.0 W/B CONN. SINGLE DIP R/A PLUG HS'G ASS'Y WITHOUT BOSS		
	CHKD:KASAKAWA	2011/07/25	10 OVER 30 UNDER	±0.25	CHECKED BY KASAKAWA	DATE 2010/08/16	MOLEX INCORPORATED			
	APPR:NUKITA	2011/07/29	30 OVER	±0.3	APPROVED BY NUKITA	DATE 2010/08/16				
REV	DESCRIPTION	ANGULAR ±1 °		MATERIAL NO. SEE SHEET1		DOCUMENT NO. SD-503660-001		SHEET NO. 2 OF 3		
B		DRAFT WHERE APPLICABLE MUST REMAIN WITHIN DIMENSIONS		THIS DRAWING CONTAINS INFORMATION THAT IS PROPRIETARY TO MOLEX INCORPORATED AND SHOULD NOT BE USED WITHOUT WRITTEN PERMISSION						

10 9 8 7 6 5 4 3 2 1

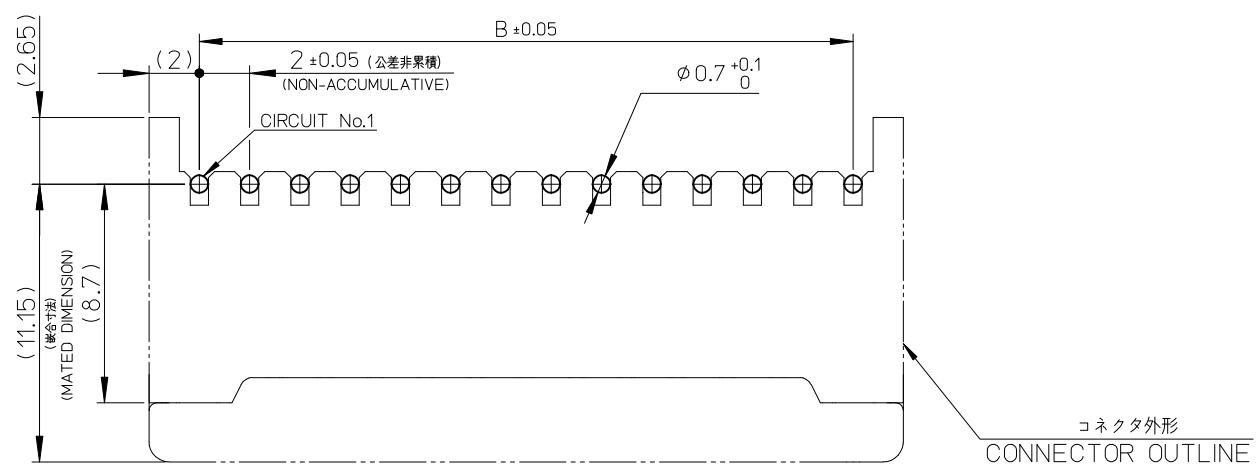

基板取付穴推奨寸法 (マウント面)  
 RECOMMENDED P.C.BOARD  
 HOLE DIMENSION  
 (MOUNTING SIDE)  
 (t=1.2~1.6)

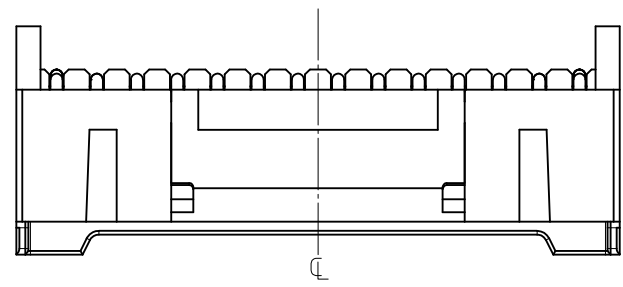

ロック面 14,15極形状  
 LOCK SIDE SHAPE OF 14,15CKT.

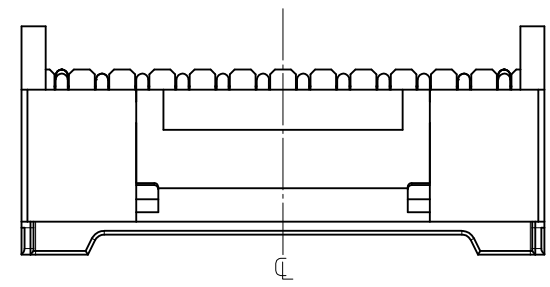

ロック面 4,5,6,8,10,12極形状  
 LOCK SIDE SHAPE OF 4,5,6,8,10,12CKT.

PROPOSED EC NO: J2012-0117 DRW:SSAT002 CHKD:KASAKAWA APPR:NUKITA	2011/07/25 2011/07/25 2011/07/29	GENERAL TOLERANCES (UNLESS SPECIFIED)		DIMENSION STYLE MM ONLY		SCALE 4:1	DESIGN UNITS METRIC	THIRD ANGLE PROJECTION	
		10 UNDER	± 0.2	DRAWN BY SSAT002	DATE 2010/08/06	TITLE 2.0 W/B CONN. SINGLE DIP R/A PLUG HS'G ASS'Y WITHOUT BOSS			
		10 OVER 30 UNDER	± 0.25	CHECKED BY KASAKAWA	DATE 2010/08/16				
		30 OVER	± 0.3	APPROVED BY NUKITA	DATE 2010/08/16	MOLEX INCORPORATED			
ANGULAR ±1 °		DRAFT WHERE APPLICABLE MUST REMAIN WITHIN DIMENSIONS		MATERIAL NO. SEE SHEET 1		DOCUMENT NO. SD-503660-001		SHEET NO. 3 OF 3	
SIZE A3		THIS DRAWING CONTAINS INFORMATION THAT IS PROPRIETARY TO MOLEX INCORPORATED AND SHOULD NOT BE USED WITHOUT WRITTEN PERMISSION							

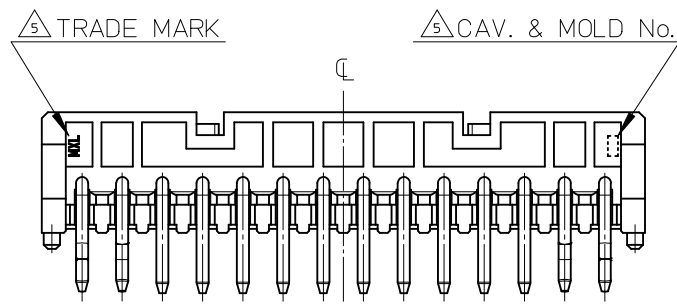
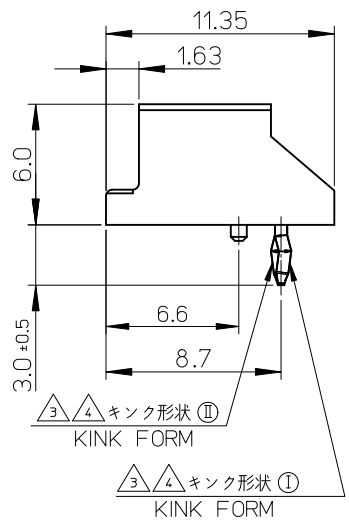
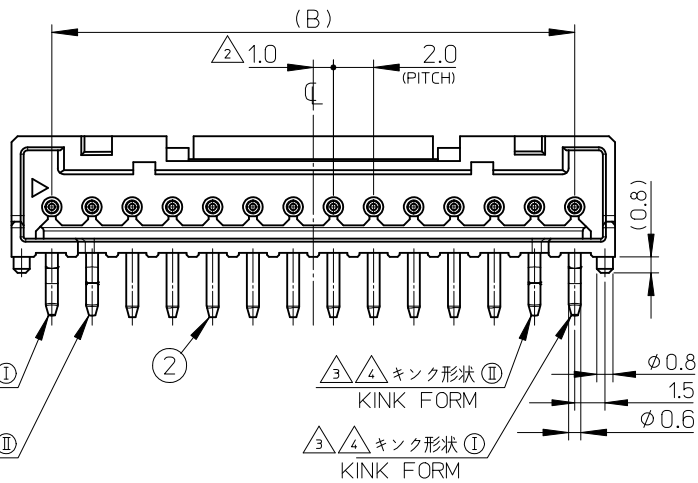
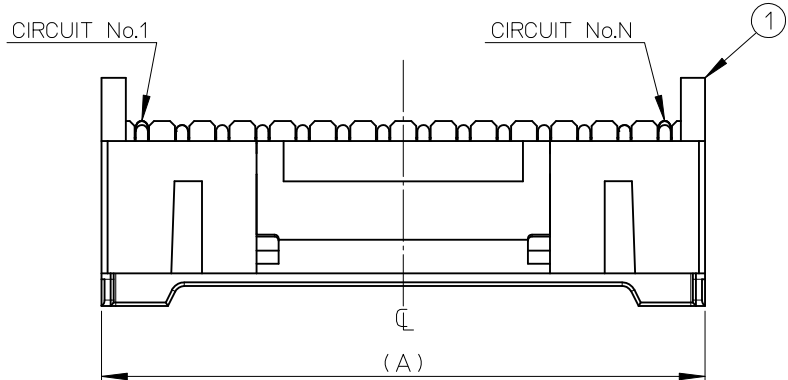

③ ④ キンク形状 ①  
KINK FORM

③ ④ キンク形状 Ⅱ  
KINK FORM

③ ④ キンク形状 ①  
KINK FORM

③ ④ キンク形状 Ⅱ  
KINK FORM

③ ④ キンク形状 ①  
KINK FORM

28	32	503660	-1500	15	503660-**00 ボス有(WITH BOSS)
26	30		-1400	14	
22	26		-1200	12	
18	22		-1000	10	
14	18		-0800	8	
10	14		-0600	6	
8	12		-0500	5	
6	10	503660	-0400	4	
B	A	TORAY PACKAGE ORDER NO.		CIRCUIT	CONNECTOR SERIES No.

No.	部品 PART	材質 MATERIAL
①	ハウジング HOUSING	ポリエステル(PBT), ガラス充填, UL94V-0 POLYESTER, GLASS FILLED, UL94V-0 色: ナチュラル(白) COLOR: NATURAL (WHITE)
②	ピン PIN	黄銅, 錫めっき BRASS, Sn PLATED

PROPOSED  
EC NO: J2012-0117  
DRWN:SSAT002 2011/03/23  
CHKD:KASAKAWA 2011/07/25  
APPR:NUKITA 2011/07/29

DESCRIPTION

GENERAL TOLERANCES (UNLESS SPECIFIED)

10 UNDER	±0.2
10 OVER 30 UNDER	±0.25
30 OVER	±0.3
ANGULAR	±1 °

DRAFT WHERE APPLICABLE  
MUST REMAIN WITHIN DIMENSIONS

REV 0

DIMENSION STYLE: MM ONLY

SCALE: 4:1

DESIGN UNITS: METRIC

THIRD ANGLE PROJECTION

DRAWN BY: SSAT002 DATE: 2010/08/06

CHECKED BY: KASAKAWA DATE: 2010/08/16

APPROVED BY: NUKITA DATE: 2011/07/29

TITLE: 2.0 W/B CONN. SINGLE DIP R/A PLUG HS'G ASS'Y WITH BOSS

MATERIAL NO. SEE CHART

DOCUMENT NO. SD-503660-002

SHEET NO. 1 OF 3

THIS DRAWING CONTAINS INFORMATION THAT IS PROPRIETARY TO MOLEX INCORPORATED AND SHOULD NOT BE USED WITHOUT WRITTEN PERMISSION

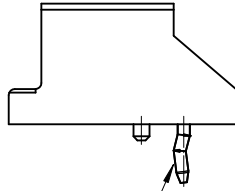
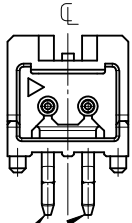
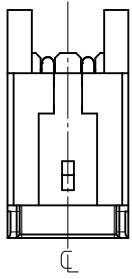

△キック形状 ②  
KINK FORM

△キック形状 ②  
KINK FORM

FIGURE OF 2 CIRCUIT  
SCALE 4:1

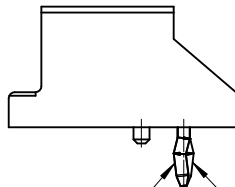
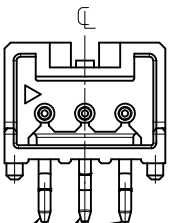
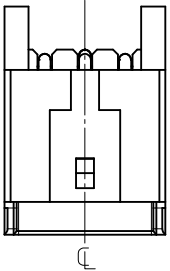

△キック形状 ②  
KINK FORM

△キック形状 ②  
KINK FORM

△キック形状 ①  
KINK FORM

△キック形状 ①  
KINK FORM

FIGURE OF 3 CIRCUIT  
SCALE 4:1

NOTES:

1. 嵌合相手: 503658 シリーズ  
MATE WITH: 503658 SERIES.

△ 偶数極に適用.  
APPLY FOR EVEN CUIUIT.

△ キックは両端2ピンに付加.  
KINK ATTACHED TO THE POSITION OF 2PINS TO BOTH OUTSIDE ENDS.

△ 2極以外のキック形状は両サイドが①、それ以外のキック形状は全て②形状とする。  
3極のキック形状は両サイドに①、2ピン目に②形状を付加する。  
MORE THAN 2 CIRCUIT : PINS AT BOTH ENDS ARE KINK FORMED TO ①  
THE OTHER PINS ARE KINK FORMED TO ②  
3 CIRCUIT : PINS AT BOTH ENDS ARE KINK FORMED TO ②  
THE OTHER PINS ARE KINK FORMED TO ①

△ トレードマーク: MXLにて表示。  
キャビティ番号: 1桁から2桁の数字にて表示。 金型番号: アルファベット1文字にて表示。  
TRADE MARK IS FORMED BY MXL.  
AND BY 1 - 2 DIGIT NUMBER (TO CAVITY No.)  
AND BY 1 LETTER OD ALPHABET (TO MOLD No.)

6. 本製品のプラスチック部に黒点等が確認される場合や、色合いが異なる場合が御座いますが、製品性能に影響は御座いません。  
THERE IS NO INFLUENCE IN THE PRODUCT PERFORMANCE THOUGH THE BLACK SPOT ETC.  
MIGHT BE CONFIRMED TO THE PLASTIC PART OF THIS PRODUCT AND  
THE SHADE MIGHT BE DIFFERENT.

7. 製品の取り扱いについては、コネクタ取扱い説明書(AS-503658-001)を参照願います。  
PLEASE REFER TO INSTRUCTION MANUAL(AS-503658-001)

8. ELV及びRoHS適合品  
ELV AND RoHS COMPLIANT

PROPOSED EC NO.: J2012-0117 DRWNS:SSAT002 CHKD:KASAKAWA APPR:NUKITA	REV DESCRIPTION 2011/03/23 2011/07/25 2011/07/29	GENERAL TOLERANCES (UNLESS SPECIFIED)		DIMENSION STYLE MM ONLY		SCALE 4:1	DESIGN UNITS METRIC	THIRD ANGLE PROJECTION		
		10 UNDER	±0.2	DRAWN BY SSAT002	DATE 2010/08/06	TITLE 2.0 W/B CONN. SINGLE DIP R/A PLUG HS'G ASS'Y WITH BOSS				
		10 OVER 30 UNDER	±0.25	CHECKED BY KASAKAWA	DATE 2010/08/16	MOLEX INCORPORATED				
		30 OVER	±0.3	APPROVED BY NUKITA	DATE 2011/07/29	MATERIAL NO. SEE SHEET 1		DOCUMENT NO. SD-503660-002	SHEET NO. 2 OF 3	
DRAFT WHERE APPLICABLE MUST REMAIN WITHIN DIMENSIONS		THIS DRAWING CONTAINS INFORMATION THAT IS PROPRIETARY TO MOLEX INCORPORATED AND SHOULD NOT BE USED WITHOUT WRITTEN PERMISSION								

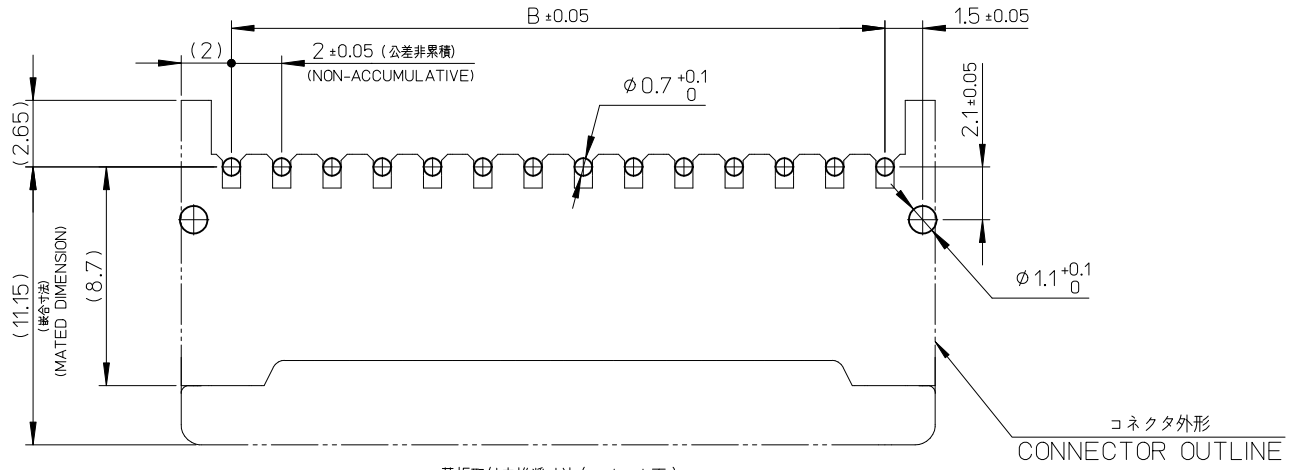

基板取付穴推奨寸法 (マウント面)  
 RECOMMENDED P.C.BOARD  
 HOLE DIMENSION  
 (MOUNTING SIDE)  
 (I=1.2~1.6)

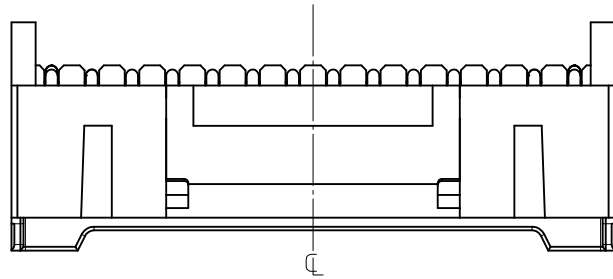

ロック面 14,15極形状  
 LOCK SIDE SHAPE OF 14,15CKT.

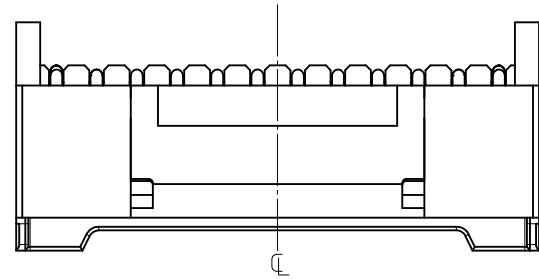

ロック面 4,5,6,8,10,12極形状  
 LOCK SIDE SHAPE OF 4,5,6,8,10,12CKT.

PROPOSED EC NO.: J2012-0117 DRWN:SSAT002 2011/03/23 CHKD:KASAKAWA 2011/07/25 APPR:NUKITA 2011/07/29	GENERAL TOLERANCES (UNLESS SPECIFIED)		DIMENSION STYLE MM ONLY	SCALE 4:1	DESIGN UNITS METRIC	THIRD ANGLE PROJECTION
	10 UNDER	± 0.2	DRAWN BY SSAT002	DATE 2010/08/06	TITLE 2.0 W/B CONN. SINGLE DIP R/A PLUG HS'G ASS'Y WITH BOSS	
	10 OVER 30 UNDER	± 0.25	CHECKED BY KASAKAWA	DATE 2010/08/16		
	30 OVER	± 0.3	APPROVED BY NUKITA	DATE 2011/07/29	MOLEX INCORPORATED	
ANGULAR	± 1 °	MATERIAL NO.	DOCUMENT NO.	SHEET NO.		
DRAFT WHERE APPLICABLE MUST REMAIN WITHIN DIMENSIONS		SEE SHEET 1	SD-503660-002		3 OF 3	
THIS DRAWING CONTAINS INFORMATION THAT IS PROPRIETARY TO MOLEX INCORPORATED AND SHOULD NOT BE USED WITHOUT WRITTEN PERMISSION						