

Jun.1.2024 Copyright 2024 HIROSE ELECTRIC CO., LTD. All Rights Reserved.  
 In case of consideration for using Automotive equipment / device which demand high reliability, kindly contact our sales window correspondents.

 ELV·RoHS COMPLIANT

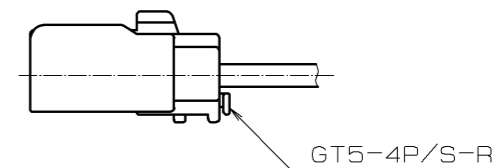

NOTE1. THIS CONNECTOR SHALL BE USED WITH A RETAINER (CL755-0058-6).

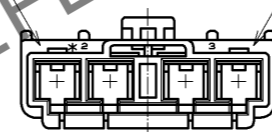
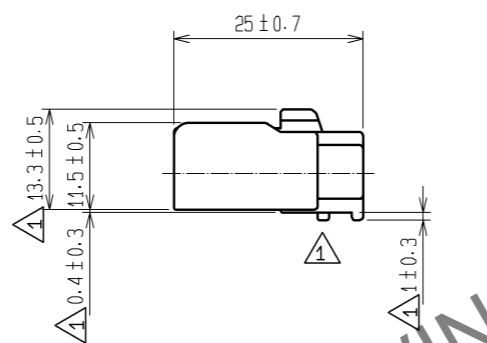
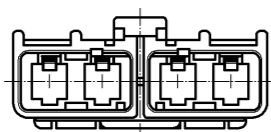
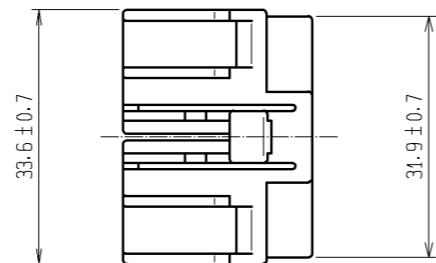

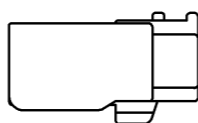
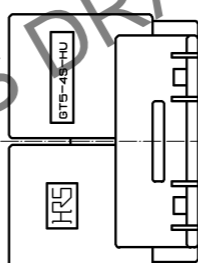
CONNECTOR ASSEMBLED WITH A RETAINER

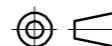

HRS DRAWING FOR REFERENCE

1	PBT	UL94HB, LIGHT GRAY						
NO.	MATERIAL	FINISH . REMARKS	NO.	MATERIAL	FINISH . REMARKS			
UNITS mm		SCALE 1 : 1	COUNT 2	DESCRIPTION OF REVISIONS DIS-T-000904		DESIGNED MH. YAMAGUCHI	CHECKED MO. OKADA	DATE 08. 07. 28
<b>HRS</b> HIROSE ELECTRIC CO., LTD.		APPROVED : KS. SATOH	05. 01. 05	DRAWING NO. EDC3-165450-00				
		CHECKED : NH. NAKATA	05. 01. 05	PART NO. GT5-4S-HU				
		DESIGNED : TS. KUBOTA	05. 01. 05	CODE NO. CL755-0056-0-00				
		DRAWN : MO. OKADA	05. 01. 05					 1/1